

SAMSUNG

SM-R720
SM-R732

User Manual

Table of Contents

Basics

- 4 Read me first
- 6 Package contents
- 7 Device layout
- 10 Battery
- 13 Wearing the Gear
- 14 Replacing the strap
- 18 Turning the Gear on and off
- 18 Connecting the Gear to a mobile device
- 20 Remote connection
- 21 Turning the screen on and off
- 21 Using the bezel
- 23 Touchscreen
- 26 Navigating the screen
- 27 Home screen
- 32 Status panel
- 34 Apps screen
- 35 Setting the screen lock
- 36 Entering text
- 39 Screen capture
- 39 Updating the Gear

Applications

- 40 Messages
- 41 Phone
- 43 S Health

- 53 Running
- 54 Schedule
- 55 S Voice
- 56 Weather
- 57 Alarm
- 57 Timer
- 58 Stopwatch
- 58 World Clock
- 59 Bloomberg
- 59 CNN
- 60 News Briefing
- 60 Music Player
- 62 Gallery
- 64 Buddy
- 64 Email
- 65 Find My Phone
- 65 Maps
- 65 Voice Memo

Settings

- 67 Introduction
- 67 Display
- 67 Vibration
- 68 Device
- 68 Call
- 69 Connections
- 72 Screen lock
- 72 Input

73 Power saving

73 Gear info

Samsung Gear

74 Introduction

75 Watch faces

75 Notifications

76 Apps layout

76 Send content to Gear

77 Settings

80 Find my Gear

80 Samsung Gear Apps

Appendix

81 Troubleshooting

85 Removing the battery

Basics

Read me first

Please read this manual before using this device to ensure safe and proper use.

- Descriptions are based on the device's default settings.
- Some content may differ from your device depending on the region, service provider, model specifications, or device's software.
- Content (high quality content) that requires high CPU and RAM usage will affect the overall performance of the device. Apps related to the content may not work properly depending on the device's specifications and the environment that it is used in.
- Samsung is not liable for performance issues caused by apps supplied by providers other than Samsung.
- Samsung is not liable for performance issues or incompatibilities caused by edited registry settings or modified operating system software. Attempting to customise the operating system may cause the Gear or apps to work improperly.
- Software, sound sources, wallpapers, images, and other media provided with this Gear are licensed for limited use. Extracting and using these materials for commercial or other purposes is an infringement of copyright laws. Users are entirely responsible for illegal use of media.
- Default apps that come with the Gear are subject to updates and may no longer be supported without prior notice. If you have questions about an app provided with the Gear, contact a Samsung Service Centre. For user-installed apps, contact service providers.
- Modifying the Gear's operating system or installing softwares from unofficial sources may result in Gear malfunctions and data corruption or loss. These actions are violations of your Samsung licence agreement and will void your warranty.
- The images in this manual are based on the SM-R720 model.
- Some functions may not work as described in this manual depending on the maker and model of the mobile device you connect to the Gear.

Maintaining water and dust resistance

The device may be damaged if water or dust enters the device. Follow these tips carefully to prevent damage to the device and to maintain the water- and dust-resistant performance of the device.

- Do not immerse the device in water deeper than 1.5 m and keep it submerged for more than 30 minutes.
- Do not immerse the device in water for extended periods.
- Do not expose the device to **water moving with force**, such as water running from a tap, ocean waves, or waterfalls.
- **If the device is exposed to freshwater, dry it thoroughly with a clean, soft cloth. If the device is exposed to any liquid other than freshwater, rinse the device with freshwater immediately and dry it thoroughly with a clean, soft cloth. Failure to rinse the device in freshwater and dry it as instructed may cause the device to suffer from operability or cosmetic issues.**
- **If the device is dropped or receives an impact**, the water- and dust-resistant features of the device may be damaged.
- The touchscreen and other features may not work properly **if the device is used in water or in other liquids.**
- **Your device has been tested in a controlled environment and certified to be water- and dust-resistant in specific situations (meets requirements of classification IP68 as described by the international standard IEC 60529 - Degrees of Protection provided by Enclosures [IP Code]; test conditions: 15 - 35°C, 86 - 106 kPa, 1.5 metre, 30 minutes). Despite this classification, your device is not impervious to water damage in any situation.**

Instructional icons



Warning: situations that could cause injury to yourself or others



Caution: situations that could cause damage to your device or other equipment



Notice: notes, usage tips, or additional information

Package contents

Check the product box for the following items:

- Gear
- Wireless charger dock
- Strap
- Quick start guide



- The items supplied with the Gear and any available accessories may vary depending on the region or service provider.
- The supplied items are designed only for this Gear and may not be compatible with other devices.
- Appearances and specifications are subject to change without prior notice.
- You can purchase additional accessories from your local Samsung retailer. Make sure they are compatible with the Gear before purchase.
- Some accessories, such as docking devices, may not have the same water- and dust-resistance certification.
- Use only Samsung-approved accessories. Using unapproved accessories may cause the performance problems and malfunctions that are not covered by the warranty.
- Availability of all accessories is subject to change depending entirely on manufacturing companies. For more information about available accessories, refer to the Samsung website.

Device layout

Gear

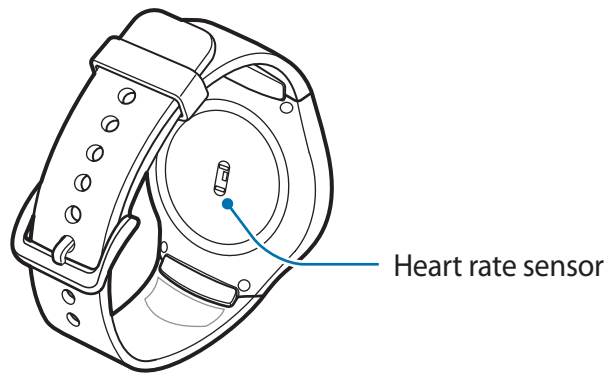
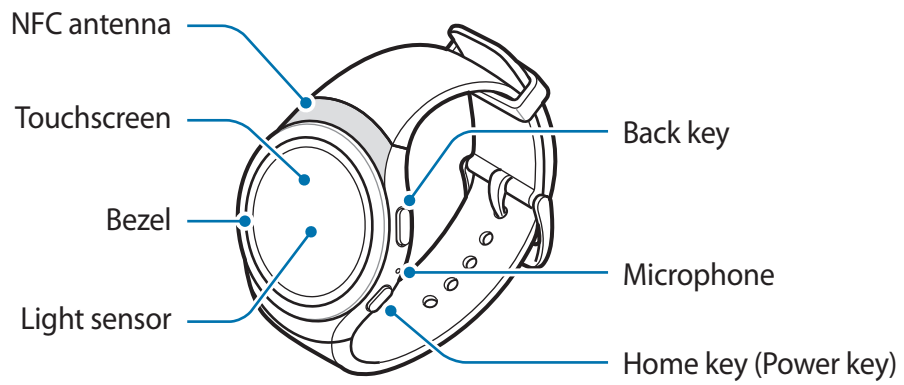

► SM-R720:

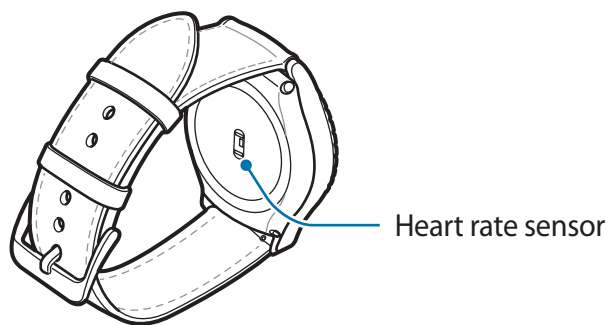
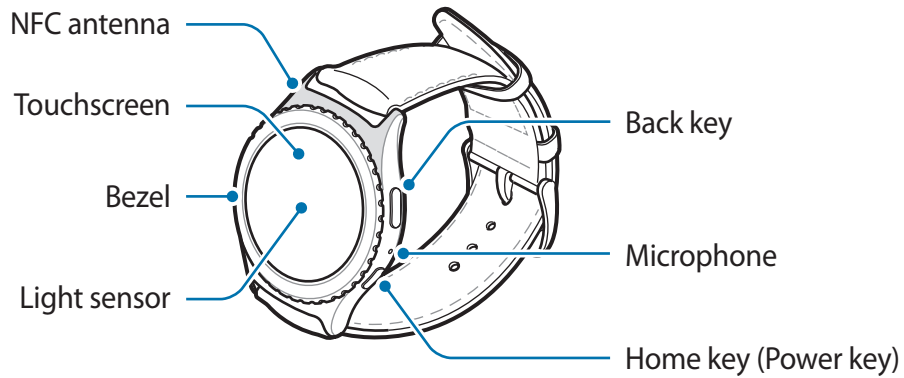

► SM-R732:



Keys

Key	Function
 Home/Power	<ul style="list-style-type: none"> • Press and hold to turn the Gear on or off. • Press to turn on the screen. • Press and hold for more than 7 seconds to restart the Gear. • Press to open the Apps screen when you are on the Watch screen. • Press to open the Watch screen when you are on any other screen.
 Back	<ul style="list-style-type: none"> • Press to return to the previous screen.

Wireless charger dock

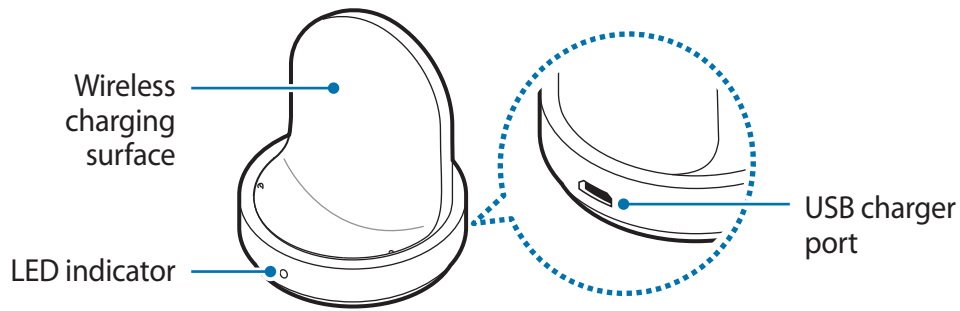

- Do not expose the Gear or the wireless charger dock to water. The devices are not completely waterproof.
- Ensure that the strap is kept clean. Contact with contaminants, such as dust and dye, can cause stains on the strap that may not be fully removed.



Make sure the Gear's microphone is not obstructed when you are speaking into it.

Battery

Charging the battery

Charge the battery before using it for the first time or when it has been unused for extended periods.



Use only Samsung-approved chargers, batteries, and cables. Unapproved chargers or cables can cause the battery to explode or damage the Gear.

- 1 Connect the USB cable to the USB power adaptor. Then, connect the other end of the USB cable to the wireless charger dock.

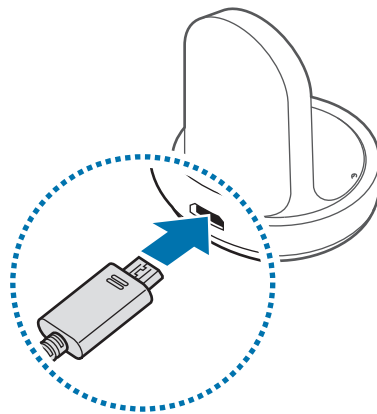

- Use the supplied wireless charger dock and charger. The Gear cannot be charged properly with a third-party charger.
- Connecting the charger improperly may cause serious damage to the device. Any damage caused by misuse is not covered by the warranty.



Ensure that the USB cable is properly connected to the wireless charger dock.

- 2 Plug the USB power adaptor into an electric socket.

- 3 Place the Gear into the wireless charger dock.

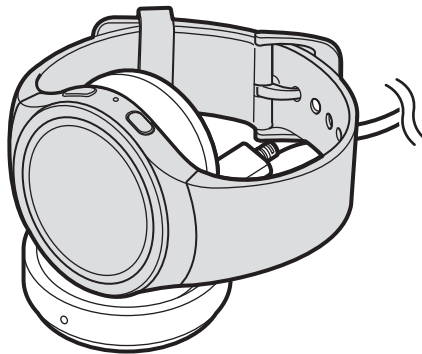

- 4 After fully charging your Gear, disconnect it from the wireless charger dock. Unplug the charger from the wireless charger dock, and then unplug the charger from the electric socket.



To save energy, unplug the charger when not in use. The charger does not have a power switch, so you must unplug the charger from the electric socket when not in use to avoid wasting power. The charger should remain close to the electric socket and be easily accessible while charging.

Checking the charging status

When you connect the Gear and the wireless charger dock, the wireless charger dock's LED indicator flashes certain colours to indicate the battery level.

Colour	Charging status
Red → Green → Orange	Standby mode
Red	Charging
Green	Fully charged
Orange	Connected to a low-power adaptor



When a wireless charger dock error occurs, the LED indicator flashes red. Disconnect the Gear from the wireless charger dock and reconnect them. If the error occurs again, contact a Samsung Service Centre for service support.

Reducing the battery consumption

Your Gear provides various options that help you conserve battery power.

- When you are not using the Gear, switch to sleep mode by covering the screen with your palm.
- Activate power saving mode.
- Close unnecessary apps.
- Deactivate the Bluetooth feature when not in use.
- Deactivate the Wi-Fi feature when not in use.
- Decrease the screen brightness.
- Deactivate the watch always on feature.
- Deactivate the voice wake-up feature in **S Voice**.
- Customise the notification settings in **Samsung Gear** on the mobile device.

Battery charging tips and precautions

- If there are obstructions between the Gear and the wireless charger dock, the Gear may not charge properly. Prevent the Gear and the wireless charger from coming into contact with sweat, liquids, or dust.
- When the battery power is low, the battery icon appears empty.
- If the battery is completely discharged, the Gear cannot be turned on immediately when the charger is connected. Allow a depleted battery to charge for a few minutes before turning on the Gear.
- If you use multiple apps at once, the battery will drain quickly. To avoid losing power during a data transfer, always use these apps after fully charging the battery.
- Using a power source other than the charger, such as a computer, may result in a slower charging speed due to a lower electric current.
- If the Gear is being charged with other devices via a multicharger, charging may take longer.

- The Gear can be used while it is charging, but it may take longer to fully charge the battery.
- If the Gear receives an unstable power supply while charging, the touchscreen may not function. If this happens, disconnect the Gear from the wireless charger dock.
- While charging, the Gear may heat up. This is normal and should not affect the Gear's lifespan or performance. If the battery gets hotter than usual, the charger may stop charging.
- If the Gear is not charging properly, take the Gear to a Samsung Service Centre.
- Avoid using a bent or damaged USB cable.

Wearing the Gear

Putting on the Gear

Open the buckle and place the strap around your wrist. Fit the strap to your wrist, insert the pin into an adjustment hole, and then secure the buckle to close it.

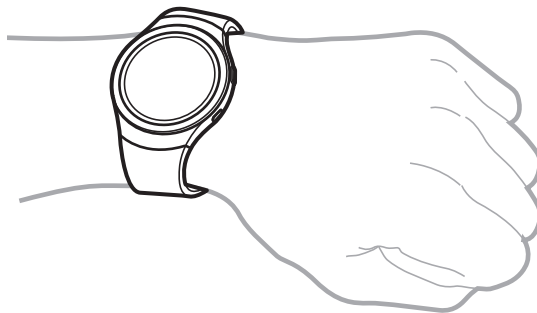

Do not bend the strap excessively. Doing so may damage the Gear.



To measure your heart rate more accurately with the Gear, wear the Gear firmly around your lower arm just above the wrist. Refer to [Wearing the Gear correctly](#) for details.

Strap tips and precautions

- Be cautious when wearing the Gear. If you have sensitive skin or fasten the Gear too tightly, you may feel some discomfort.
- Some people may experience discomfort when wearing the Gear for prolonged periods.
- Skin irritation may occur if the strap is exposed to soap, sweat, allergens, or pollutants for long periods.
- Do not wear the device too tightly. Make sure to keep the device clean and dry. Though this device has met international safety standards, some people may experience skin irritation if they are allergic to certain substances.
- Keep in mind the followings to protect the leather strap.
 - Avoid exposing the leather strap to direct sunlight, water, and hot or humid environments. The leather strap can become discoloured or deformed.
 - The leather is permeable so it can be contaminated by oil and cosmetics. Avoid exposing the leather strap to these products.

Replacing the strap

Detach the strap from the Gear to replace it with a new one.

► SM-R720:

- 1 Push the button where the Gear's body and strap meet.

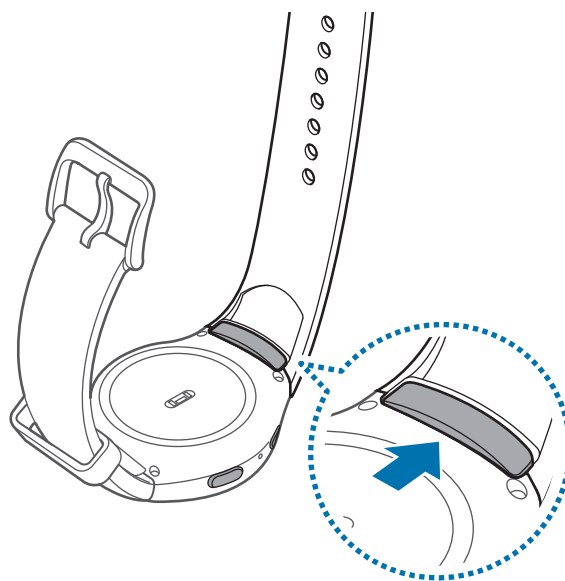

2 While pushing the button, pull the strap upwards and remove it.

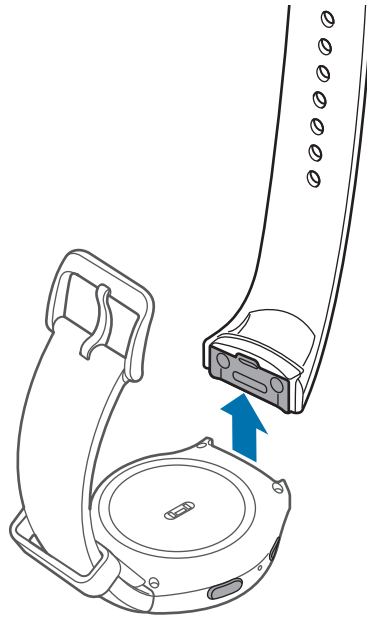

3 Insert the holder of new strap into the grooves on the Gear's body.

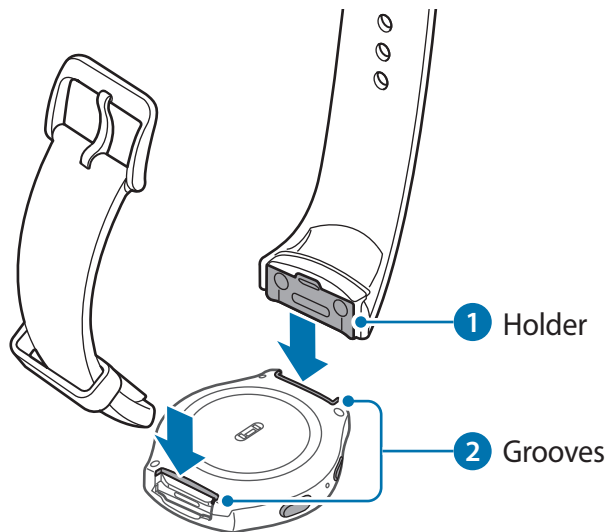

4 Push the strap into the Gear's body until it clicks into place.

► SM-R732:

1 Slide the strap's spring bar inwards.

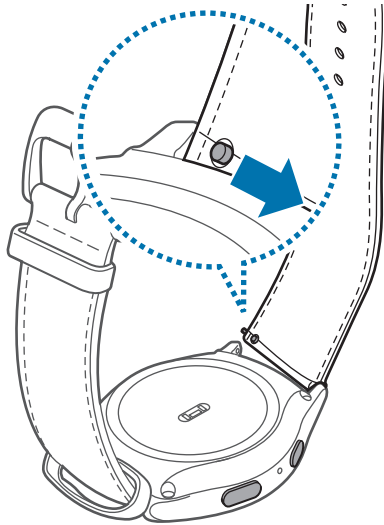

2 Pull the strap away from the Gear's body.

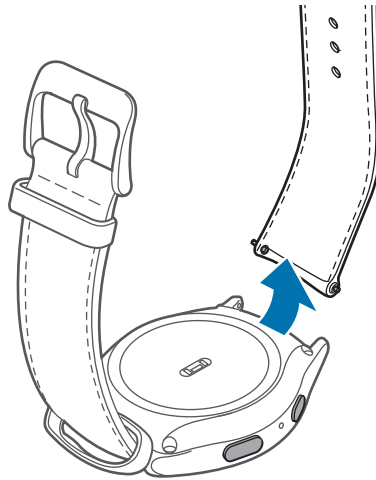

- 3 Insert one end of the spring bar into the Gear's lug and slide the spring bar inwards and connect the strap.

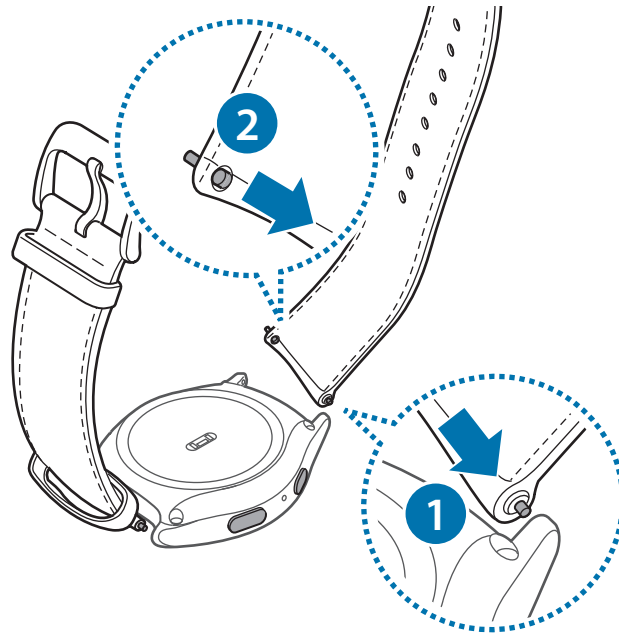

Turning the Gear on and off

Press and hold the Power key for a few seconds to turn on the Gear. When you turn on the Gear for the first time or reset it, a pop-up window will appear. Follow the on-screen instructions to download and install the Samsung Gear app on your mobile device. Refer to [Connecting the Gear to a mobile device](#) for details.

To turn off the Gear, press and hold the Power key, and then tap **Power off**.

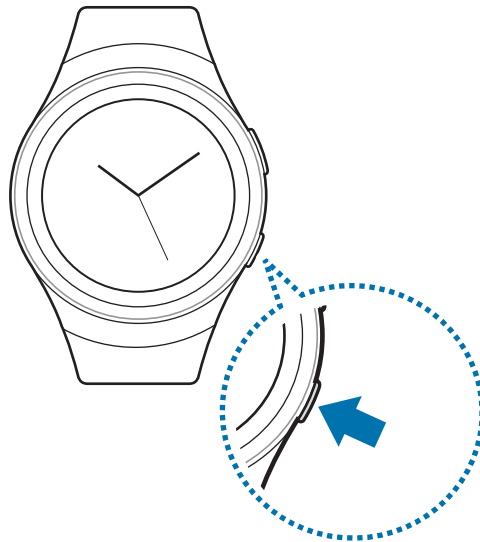

Follow all posted warnings and directions from authorised personnel in areas where the use of wireless devices is restricted, such as aeroplanes and hospitals.

Connecting the Gear to a mobile device

You should connect your Gear to your mobile device once before using the Gear. To connect your Gear to a mobile device, install the Samsung Gear app on the mobile device. Depending on your device, you can download the Samsung Gear app from the following places:

- Samsung Android devices: **Galaxy Apps**, apps.samsung.com/gear
- Other Android devices: **Play Store**, apps.samsung.com/gear
- iOS devices: **App Store**

Gear

- 1 Turn on the Gear.

Mobile device

2 On the Apps screen, tap **Samsung Gear**.

If necessary, update the Samsung Gear app to the latest version.

3 Tap **CONNECT TO GEAR**.

4 When the **Bluetooth pairing request** window appears, confirm the passkeys displayed on your Gear and mobile device match. Then, tap **OK**.

5 Follow the on-screen instructions to complete the connection.

When the devices are connected, an on-screen tutorial will appear on the Gear's screen. Follow the on-screen instructions to learn the Gear's basic controls.

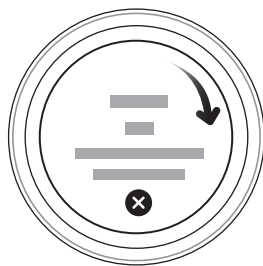

- Connection methods and screenshots may vary depending on your device and software version.
- You cannot install the Samsung Gear app on the mobile devices that do not support Gear syncing. Ensure that your mobile device is compatible with a Gear.
- Supported mobile devices and features may vary depending on your region, service provider, and device manufacturer. Visit www.samsung.com to see a list of compatible devices.

Connecting the Gear to a new mobile device

When you connect the Gear to another mobile device, a pop-up window will ask you to reset the Gear. Make sure you back up any important data stored in your Gear.

- 1 Back up your Gear's data on your mobile device.
On your mobile device, open the Apps screen and tap **Samsung Gear** → **Settings** → **Back up and restore** → **Back up data**.
- 2 End the connection between your Gear and mobile device. Refer to [Disconnecting the Gear](#) for more information.
- 3 Connect your Gear to another mobile device.
Refer to [Connecting the Gear to a mobile device](#) for more information.



If the mobile device you want to connect to is already connected to another Gear, your Gear cannot establish a connection. Disconnect your mobile device from the previous Gear to connect to your current Gear.

Remote connection

You can remotely connect the Gear to your mobile device when a Bluetooth connection is not available. With this connection, you can still receive notifications from your mobile device. This feature is automatically activated when you connect to your mobile device via Bluetooth for the first time.

If this feature is not turned on, on your mobile device, open the Apps screen, tap **Samsung Gear** → **Settings** → **Gear connection**, and then tap the **Remote connection** switch.

Turning the screen on and off

To turn on the screen, rotate the bezel. Or, press the Home key or the Back key.

To turn off the screen, cover it with your palm. Also, the screen will turn off if the Gear is not used for a specified period.

You can also turn on the screen using a gesture. Refer to [Device](#) for more information.

Using the bezel

Rotate the bezel to easily control the Gear's various functions.



- Make sure the bezel area is free from the foreign materials.
- Do not use the bezel near magnetic fields as they may interfere with the bezel's internal magnets and cause it to malfunction.



If the bezel does not rotate, take it to a Samsung Service Centre. Do not disassemble the Gear.

Scrolling through screens

Rotate the bezel to view other screens. On the Watch screen, rotate the bezel anticlockwise to view notifications.

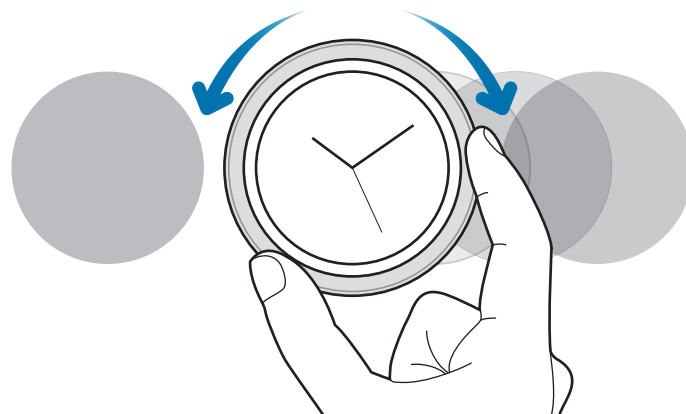

Selecting an item

Rotate the bezel to highlight the item you want to select and then tap the item. When you rotate the bezel, the highlight indicator will move in the same direction.

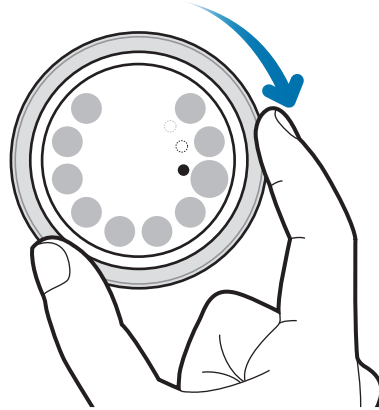

Adjusting the input value

Rotate the bezel to adjust the volume or brightness. When adjusting the brightness, rotate the bezel clockwise to make the screen brighter.

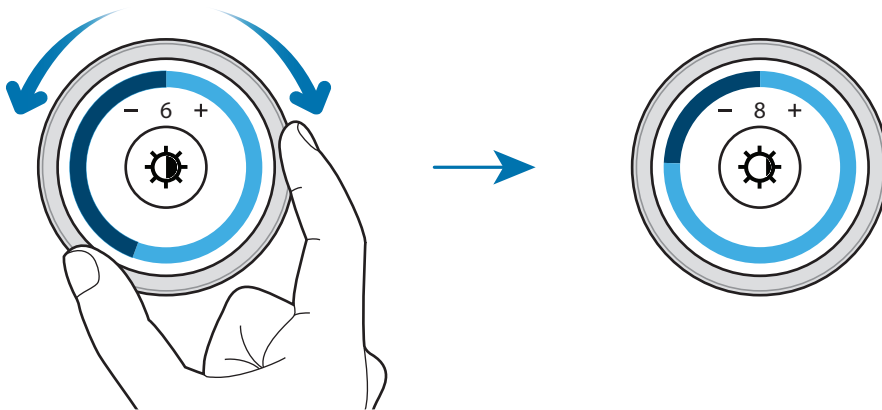

Touchscreen



- Do not allow the touchscreen to come into contact with other electrical devices. Electrostatic discharges can cause the touchscreen to malfunction.
- To avoid damaging the touchscreen, do not tap it with anything sharp or apply excessive pressure to it with your fingertips.



The Gear may not recognise touch inputs close to the edges of the screen, which are outside of the touch input area.

Tapping

To open an app, to select a menu item, or to press an on-screen button, or to enter a character using the keyboard on the screen, tap it with your finger.

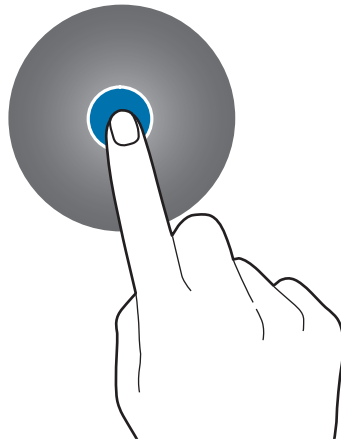

Tapping and holding

Tap and hold the screen for two or more seconds to access the Edit mode or to view available options.

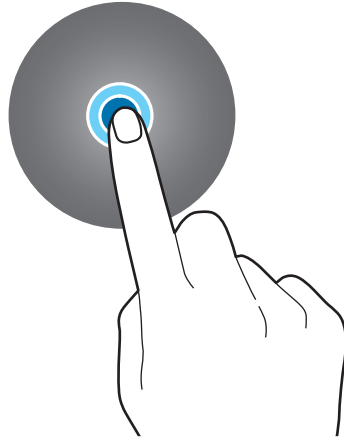

Dragging

To move an item, tap and hold it and drag it to the target position.



Double-tapping

Double-tap on an image or text to zoom in. Double-tap again to return.

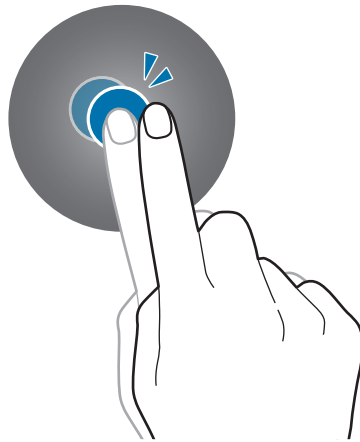

Swiping

Swipe to the left or right to view other panels.

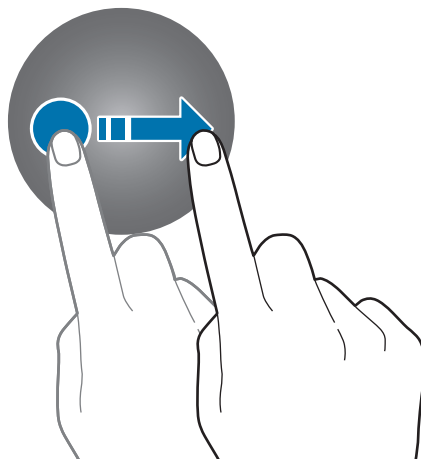

Navigating the screen

Switching between the Watch and Apps screen

On the Watch screen, press the Home key to open the Apps screen.

When you are not on the Watch screen, press the Home key to return to the Watch screen.

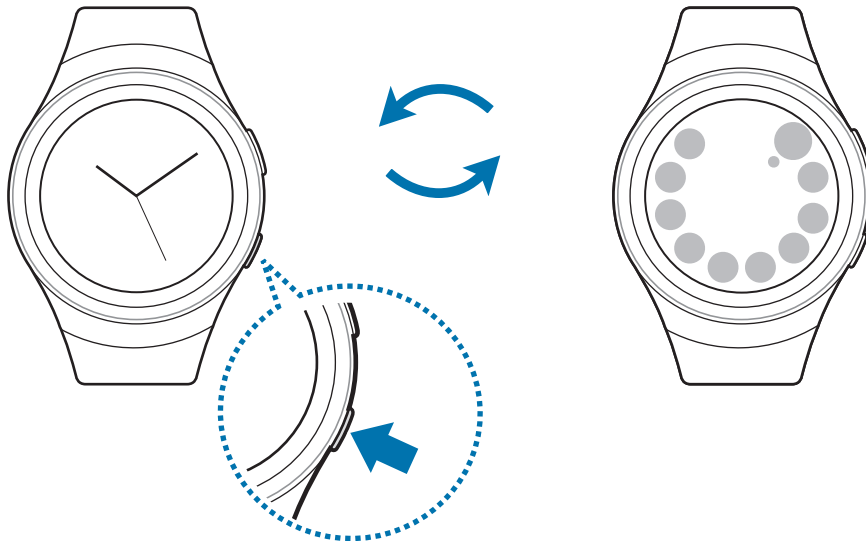

Returning to the previous screen

Press the Back key. You can also swipe down from the top edge of the screen.

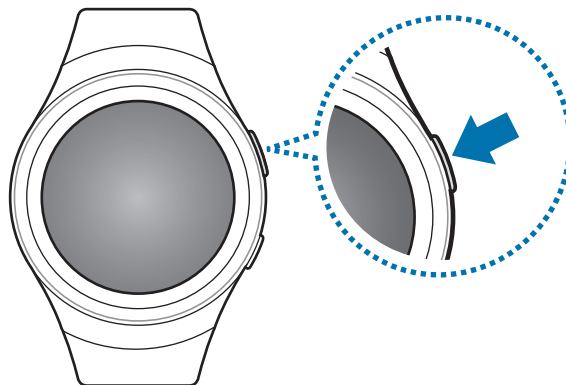

Home screen

Introduction

The Home screen can have multiple panels. The Watch screen is the starting point of the Home screen. Rotate the bezel to view items on the screen, such as notifications and widgets.

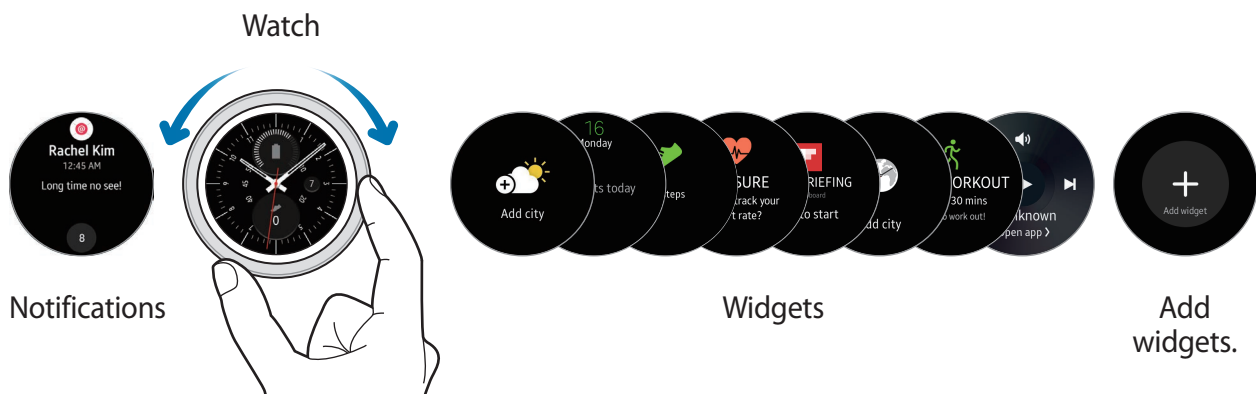

Available widgets, notifications, and their arrangement may vary depending on the software version.

Notifications panel

Stay up to date with events, notifications, and messages from your mobile device.

When you receive a notification, it appears at the top of the screen and disappears after a few seconds and the Gear vibrates.



Your Gear does not have a speaker so the Gear only vibrates when the notification is arrived and you cannot hear any sound. To configure the vibration settings, refer [Vibration](#) for more information.

Viewing incoming notifications

Tap the notification screen. You can view the notification's detail.

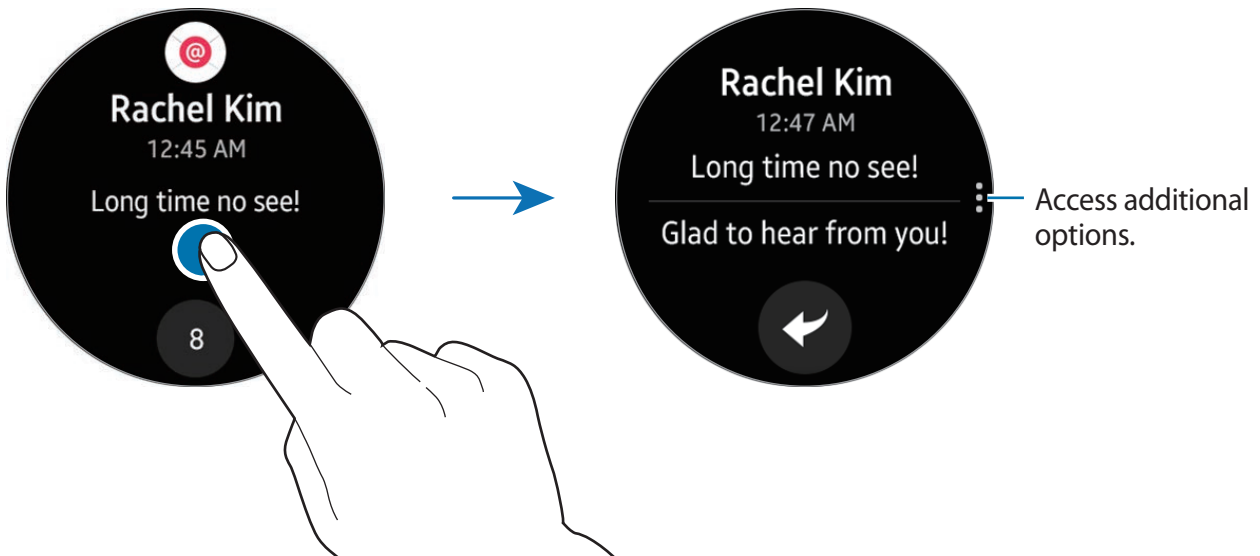

If a message includes long text or attachments, check the message details on your mobile device.

Viewing other notifications

Tap the number at the bottom of the panel. You can view other notifications received from the same app. To view notifications received from other apps, rotate the bezel anticlockwise.

Deleting notifications

Delete a notification by swiping upwards from the bottom edge of the screen while viewing a notification.

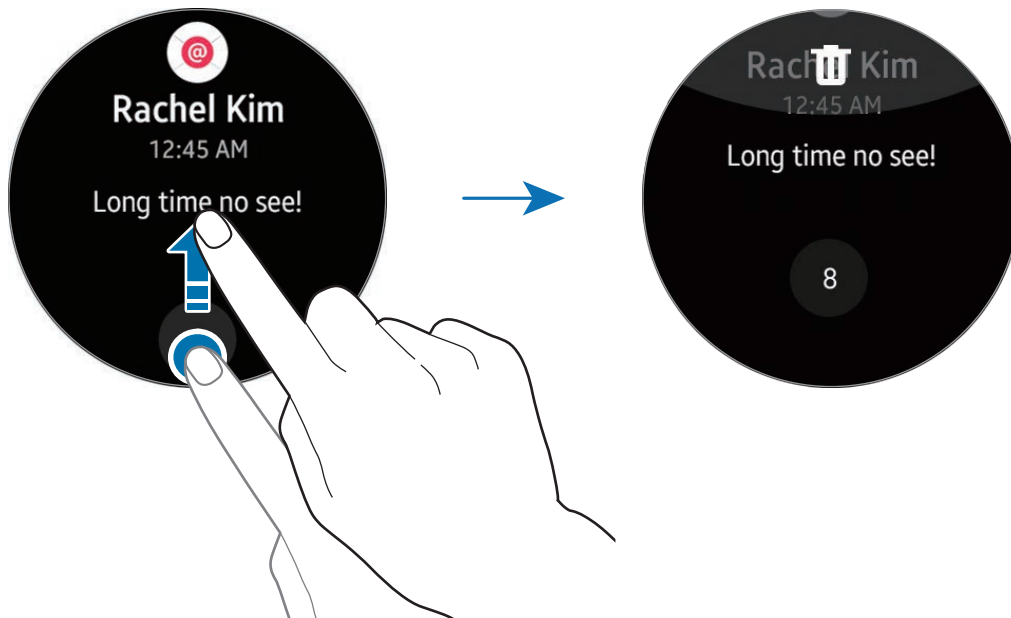

Blocking notifications

- 1 Select a notification from the app you want to block.
- 2 Tap the notification to view the details.
- 3 Tap , rotate the bezel to **Block app** and tap **Block app**.

The Gear will no longer receive notifications from the app.



You can block notifications from specific apps on the Gear. When you have not received any notifications on your Gear, block notifications via your mobile device. On your mobile device, open the Apps screen, tap **Samsung Gear** → **Notifications** → **Manage notifications**.

Watch screen

View the current time. You can also check the battery life, the date, your step count, and more.



Press the Home key to open the Watch screen when you are not on the Watch screen.

When there are unchecked notifications, an orange dot will be visible on the screen.

Changing the watch face

Tap and hold the Watch screen, then rotate the bezel to select a watch face. You can also customise the watch by tapping **STYLISE**.

You can also change the Gear's watch face on your mobile device. On the mobile device, open the Apps screen, tap **Samsung Gear** → **Watch faces**.

Widgets

You can add widgets to the Home screen. Widgets are small apps that offer limited functionality to provide information and convenient access. You can use the following widgets by default.

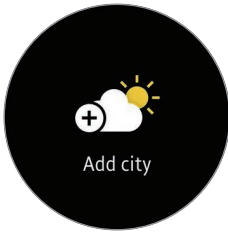

Weather

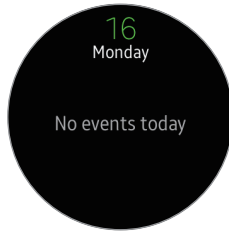

Schedule

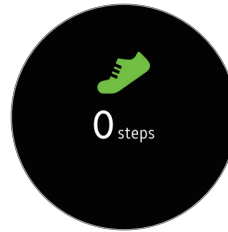

Step tracker



Heart rate tracker



News Briefing

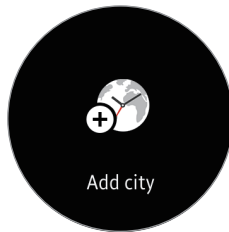

World Clock



Exercise tracker

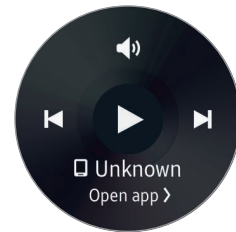

Music Player

Adding widgets

You can add more widgets on the Home screen.

Tap **+** and select a widget. The selected widget will appear in a new panel.



Removing widgets

Tap and hold a widget and then tap **-**.

Status panel

This panel allows you to view the current status and configure basic settings.

On the Watch screen, swipe downwards from the top edge of the screen.

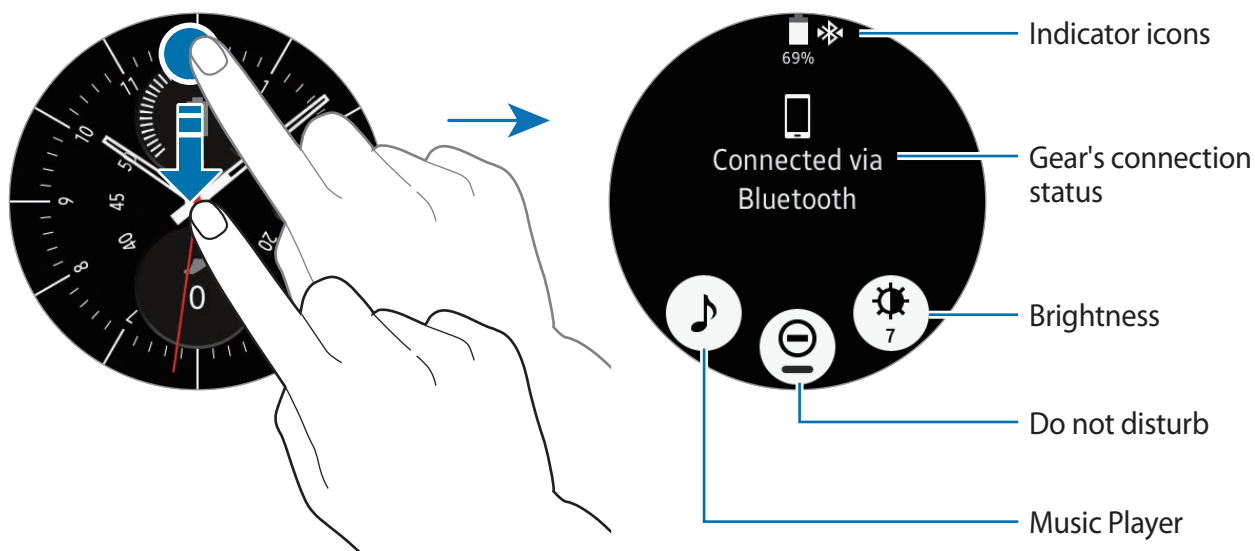





Indicator icons

Indicator icons appear at the top of the screen. The icons listed in the table below are most common.



The indicator icons shown may vary depending on the region.

Icon	Meaning
	Bluetooth connected
	Bluetooth disconnected
	Bluetooth headset connected
	Wi-Fi connected
	Battery power level

Playing music

You can play music saved in the Gear or mobile device.

On the status panel, tap .

Do not disturb mode

You can set the Gear not to vibrate and turn on the screen when a notification is received. Alarms will still function normally.

On the status panel, tap .

The  icon will appear at the top of the Watch screen.

Adjusting the brightness

You can adjust the Gear's display brightness to suit the environment.

On the status panel, tap  and adjust the brightness by rotating the bezel, or tap  or .

Apps screen

The Apps screen displays icons for all apps.

On the Watch screen, press the Home key to go to the Apps screen.

To view other panels, rotate the bezel. You can also tap  or swipe the screen to the left or right.



Opening apps

On the Apps screen, tap an app icon to open the app.

To open an app from the list of recently used apps, tap **Recent apps** on the Apps screen and select the recent app window.

Closing apps

- 1 On the Apps screen, tap **Recent apps**.
- 2 Rotate the bezel to highlight the app you want to close.
- 3 Tap .

To close all running apps, tap **CLOSE ALL**.

Moving items

On the Apps screen, tap and hold the screen, tap and hold an app and then drag it to the desired location.

You can also arrange the Gear's apps on your mobile device. Refer to [Apps layout](#) in the Samsung Gear app for more information.



Installing apps

You can purchase and download apps specially designed for the Gear. To use this feature, your Gear and mobile device must be connected.

On the Apps screen, tap **Get more apps**.

The **Samsung Gear Apps** store will automatically launch on your mobile device. In the store, you can browse and download apps.

Uninstalling apps

On the Apps screen, tap and hold the screen. The  icon appears on the apps that you can uninstall. Select an app and tap .

You can also uninstall apps from the Gear via your mobile device. Refer to [Uninstalling apps](#) in the Samsung Gear app for more information.

Setting the screen lock

Prevent others from accessing your Gear when you are not wearing it. If you have enabled the screen lock feature, it will activate when you take off the Gear. After activating this feature, the Gear requires an unlock code whenever you turn on the screen.

Setting a PIN

On the Apps screen, tap **Settings** → **Screen lock** → **Screen lock** → **PIN**.

A PIN consists of numbers only. Enter four numbers, and then enter the PIN again to verify it.

Unlocking the Gear

Turn on the screen and enter the unlock code.

To deactivate this feature, on the Apps screen, tap **Settings** → **Screen lock** → **Screen lock**, enter your PIN, and then tap **None**.

Entering text

Introduction



A text input screen will appear automatically when you are able to enter text. Select an emoticon or text template to enter a message. You can also use voice input or the keyboard to type texts.

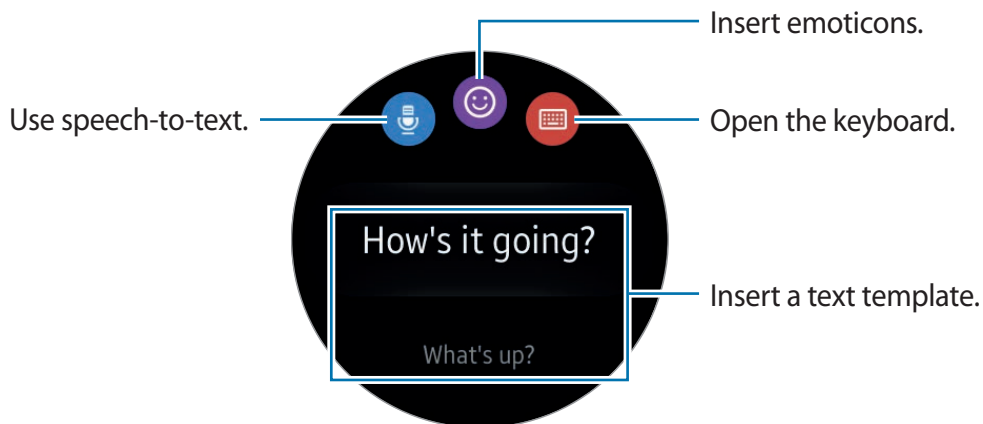

The screen layout may be different depending on the app you launch.



Using the voice input

Tap  and speak the message you want to enter. When you are finished, tap .

To change the language recognised, tap  → **Language**.

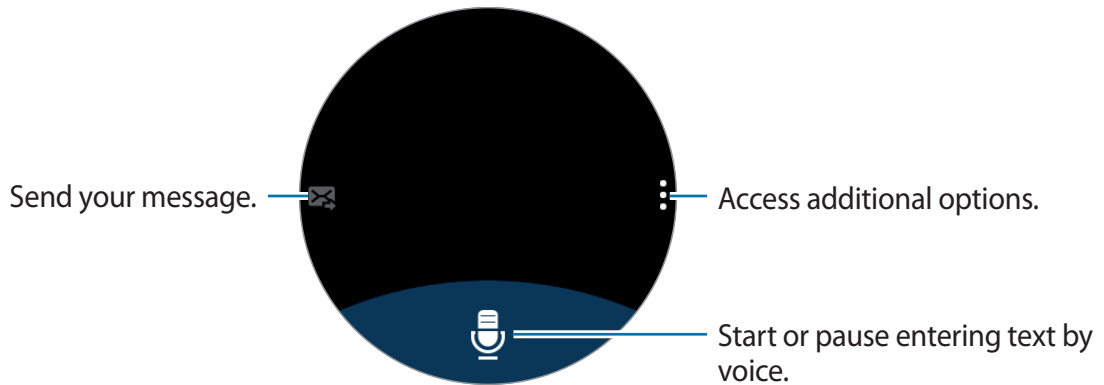

- This feature is not supported in some languages.
- When the Gear is connected to a mobile device via Bluetooth, the language settings applied on the mobile device are applied to the Gear.
- **Tips for better voice recognition**
 - Speak clearly.
 - Speak in quiet places.
 - Do not use offensive or slang words.
 - Avoid speaking in dialectal accents.

The Gear may not recognise your spoken message depending on your surroundings or how you speak.

Using keyboard

A key has three or four characters. To enter a character, tap the corresponding key repeatedly until the desired character appears.



- Text entry is not supported in some languages. To enter text, you must change the input language to one of the supported languages.
- The keyboard layout may differ depending on the region.

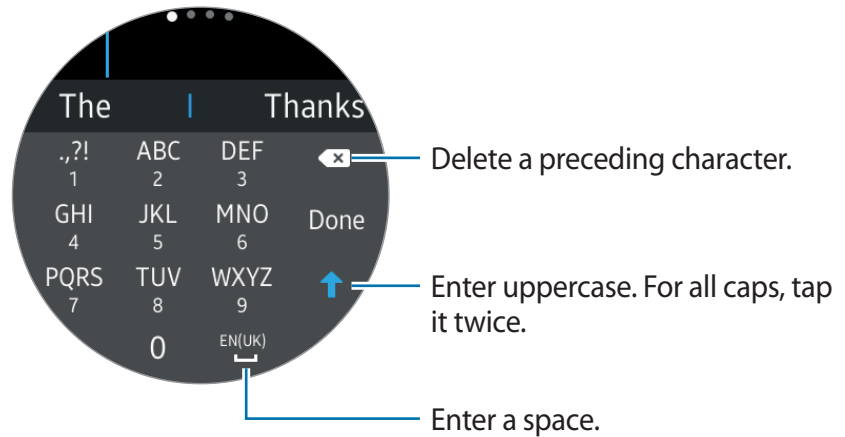

Changing the input mode

Rotate the bezel to change the input mode. You can switch between character mode, number mode, punctuation mode, and emoticon mode.

Changing the input language

Slide the space key left or right.

To add more languages, switch to number mode, punctuation mode, or emoticon mode.

Then, tap  → **Select input languages** and select a language to add. You can use up to two languages.

Screen capture

Capture a screenshot while using the Gear.

Press and hold the Home key and swipe your finger to the right across the screen.

You can view captured images in **Gallery**.



It is not possible to capture a screenshot while using some apps and features.

Updating the Gear

The Gear can be updated to the latest software.

Updating over the air

The Gear can be directly updated to the latest software by the firmware over-the-air (FOTA) service.

- 1 Tap **Samsung Gear** on the Apps screen of the mobile device.
- 2 Tap **Settings**.
- 3 Tap **About Gear** → **Update Gear software** → **Update now**.
- 4 Tap **DOWNLOAD** and install the latest software on your mobile device.
- 5 Read the on-screen information and tap **OK**.

The Gear will copy the updated software from your mobile device and restart.



To automatically check for available updates, tap the **Auto check for updates** switch to activate it. Updates will be downloaded only when the device is connected to a Wi-Fi network.

Applications

Messages

Introduction

View messages and reply to or call the sender using the Gear.

Viewing messages

- 1 Tap **Messages** on the Apps screen.
- 2 Scroll through the message list, and then select a contact to view your conversations.
To view a message on your mobile device, tap **⋮** → **Show on phone**.
To reply to a message, tap **↩** and enter your message.

Sending messages

- 1 Tap **Messages** on the Apps screen.

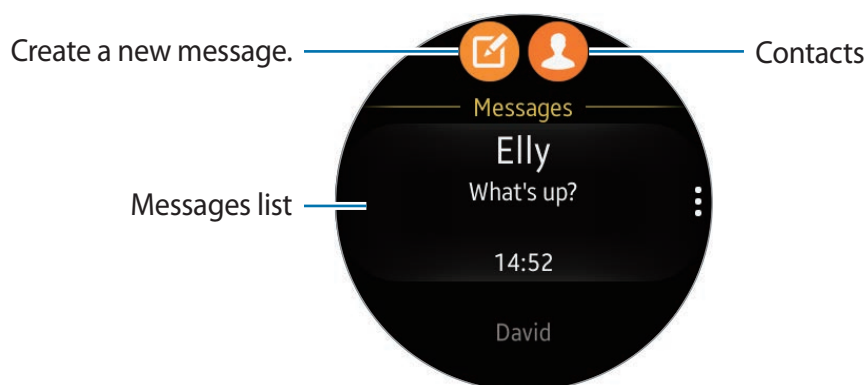

- 2 Tap **✍**.
Or, you can choose a message recipient by tapping **👤** or selecting a contact from a contact on the messages list.

3 Add a recipient and tap **NEXT**.

4 Enter text using one of available methods.

Messages will automatically be sent to the recipients.

If you type texts using voice input or the keyboard, tap  to send the message.

Phone

Introduction

You can initiate calls or receive notifications for incoming calls. Call conversations are only possible on the connected mobile device.

Receiving calls

Answering a call

When a call comes in, drag  to the right.

The call feature will automatically launch on your mobile device. Use your mobile device to have a conversation.

If the voice control feature is activated, say “Answer” to answer the call. Refer to [Call](#) for more information.

Rejecting a call

Reject an incoming call and send a rejection message to the caller.

When a call comes in, drag  to the left. To send a message when rejecting an incoming call, swipe upwards from the bottom edge of the screen.

If the voice control feature is activated, say “Reject” to reject the call. Refer to [Call](#) for more information.

Missed calls



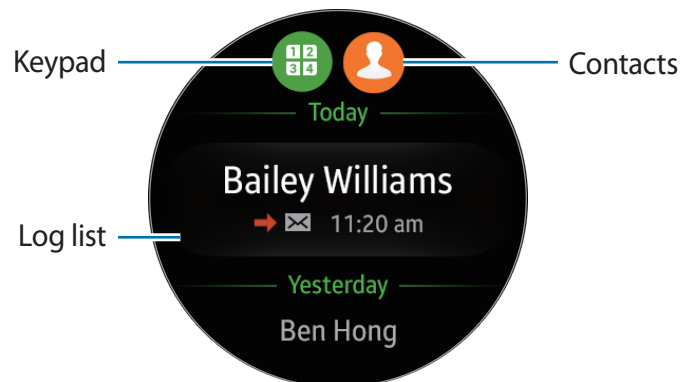

If a call is missed, a notification appears on the screen. On the Watch screen, rotate the bezel anticlockwise to view missed call notifications. Alternatively, tap **Phone** on the Apps screen to view missed calls.

Making calls

Tap **Phone** on the Apps screen.



Use one of the following methods:

- Tap , enter a number using the keypad, and then tap .
- Tap , search or select a contact, and then tap .
- Scroll through the log list, select a log entry, and then tap .

When you initiate a call on the Gear, the call will automatically launch on your mobile device. Use your mobile device to have a conversation.

Making emergency calls

To make an emergency call, use your mobile device. When you try to initiate an emergency call on the Gear, a pop-up window will prompt you to use your mobile device.

S Health

Introduction

S Health helps you manage your wellness and fitness. Set fitness goals and regularly record and check your progress.

When the Gear is synced with a compatible S Health app, you can use additional features. The additional features include checking your heart rate logs individually, and more.

Tap **S Health** on the Apps screen. When running this app for the first time or after performing a data reset, tap **START**.



The 24-hour activity log, Steps, Exercise, Heart rate, Water, and Caffeine trackers are intended only for leisure, well-being, and fitness purposes. They are not intended for medical use. Before using these features, read the instructions carefully.

Wearing the Gear correctly

When measuring your heart rate, wear the Gear snugly on your arm above your wrist as shown in the figure below. Do not fasten the Gear too tightly.

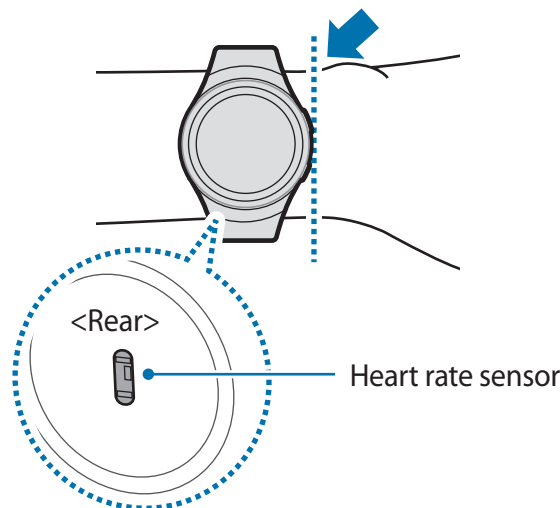



- The accuracy of the heart rate sensor may be diminished depending on measurement conditions and surroundings.
- Use the HR feature only for measuring your heart rate.
- Do not look directly at the heart rate sensor's lights. Doing so may impair your vision. Make sure children do not look directly at the lights.
- Cold ambient temperatures may affect your measurement; during winter or cold weather, keep yourself warm when checking your heart rate.
- Take heart rate measurements when you are seated and relaxed. Do not move your body while taking heart rate measurements. Doing so may cause your heart rate to be recorded inaccurately.
- If you receive a reading that is very different from your expected heart rate, rest for 30 minutes and then measure again.
- Smoking or consuming alcohol before taking measurements may cause your heart rate to be different from your normal heart rate.
- Do not talk, yawn, or breathe deeply while taking heart rate measurements. Doing so may cause your heart rate to be recorded inaccurately.
- Because the heart rate sensor uses light to approximate heart rate, its accuracy may vary due to physical factors that affect light absorption and reflection, such as blood circulation/blood pressure, skin condition and location and concentration of blood vessels. In addition, if your heart rate is extremely high or low, measurements may be inaccurate.
- Users with thin wrists may receive inaccurate heart rate measurements when the device is loose, causing the light to be reflected unevenly. If heart rate measurement is not working properly, adjust the position of the device's heart rate sensor to the right, left, up, or down on your wrist, or turn the device so the heart rate sensor sits firmly against the inside of your wrist.
- If the heart rate sensor is dirty, wipe the sensor and try again. Obstructions between the device's strap and your wrist, such as body hair, dirt, or other objects may prevent the light from reflecting evenly. Please make sure you remove such obstructions before use.
- If your device becomes hot to the touch, remove it until it cools. Exposing skin to a hot surface of the device for a long time may cause skin burn.

24-hour activity tracker

Your Gear can monitor and record your activities during the day and encourage you to stay healthy.

Tap **S Health** on the Apps screen.



- **Healthy activity:** It indicates whether you are walking or running. If you have made more than 100 steps per minute for at least 10 consecutive minutes, the Gear will encourage you to keep going.
- **Light activity:** This indicates the time spent doing light activity, but not hard exercise or inactivity.
- **Inactive time:** This indicates the time spent not moving for one hour or more. To help you stay active, the Gear will prompt you to move after 50 minutes of inactivity.

Tap the screen and rotate the bezel to view the details of your activity log.



Steps tracker

The Gear counts the number of steps you have taken and measures the distance travelled.

- 1 Tap **S Health** on the Apps screen.
- 2 Rotate the bezel clockwise and open the steps tracker panel.



Tap the screen to view a graph of your step count records. To view records by day, rotate the bezel.



- You may experience a brief delay while the steps tracker monitors your steps and then displays your step count. You may also experience a brief delay before the pop-up window indicates that your goal has been reached.
- If you use the steps tracker while travelling by car or train, vibration may affect your step count.

Exercise tracker

Record your exercise information and calories burned using S Health's exercise feature.



- When your Gear and mobile device are connected, this feature uses your mobile device's location information. If the mobile device's location feature is not activated, it is automatically activated.
- Before using this feature, pregnant women, the elderly, and young children, users suffering from conditions, such as chronic heart disease or high blood pressure, are recommended to seek the advice of a licensed medical professional.
- If you feel dizzy, experience pain, or have difficulty breathing during exercise, stop using this feature and seek the advice of a licensed medical professional.

Be aware of following conditions before exercising in cold weather conditions:

- Avoid using the device in cold weather. If possible, use the device indoors.
- If you use the device outside in cold weather, cover the Gear with your sleeves before using it.
- If you have just purchased or have reset the Gear, read the on-screen information about the app and create your profile.

Exercising with the Gear

- 1 Tap **S Health** on the Apps screen.
- 2 Rotate the bezel clockwise and open the exercise tracker screen.
- 3 Tap  and select the type of exercise you want to monitor.

- 4 Tap ✓ to allow this app to use your current location while exercising.
Your location information sharing preference will be saved as the default.
- 5 Rotate the bezel clockwise to select a target type.
- 6 Tap the target value.
- 7 Rotate the bezel to set the target and tap **SET**.
- 8 Tap **START** to start monitoring your exercise.
You can view exercise information, such as calories burned and current speed, when you rotate the bezel.
To listen to music via a Bluetooth headset, rotate the bezel anticlockwise.

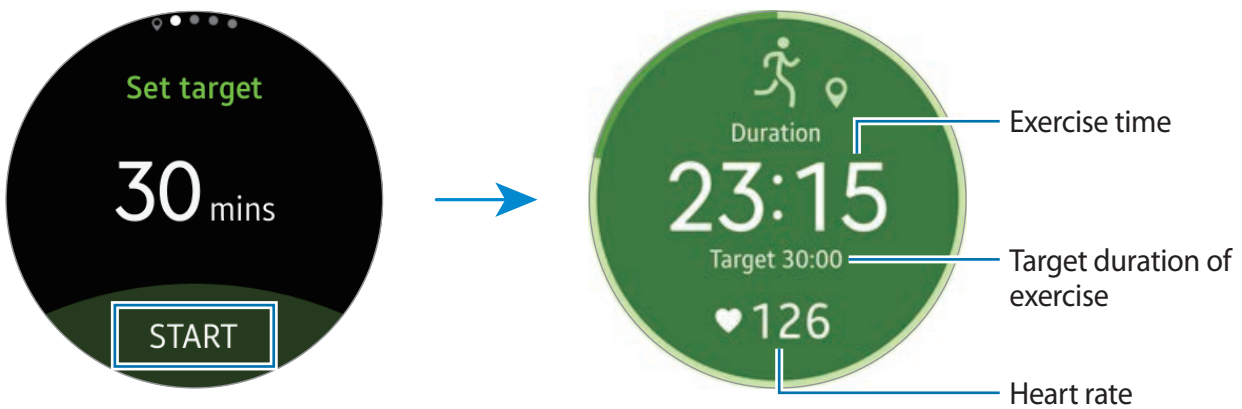

- 9 To finish exercising, tap the screen and tap **PAUSE** → ■.
- 10 Rotate the bezel to view your exercise information.

Heart rate tracker

Measure and record your heart rate.



- The Gear's heart rate tracker is intended for fitness and informational purposes only and is not intended for use in the diagnosis of disease or other conditions, or in the cure, mitigation, treatment, or prevention of disease.
- To measure your heart rate more accurately with the Gear, wear the Gear firmly around your lower arm just above the wrist. Refer to [Wearing the Gear correctly](#) for details.

Be aware of following conditions before measuring your heart rate:

- Rest for 5 minutes before taking measurements.
- If the measurement is very different from the expected heart rate, rest for 30 minutes and then measure it again.
- During winter or in cold weather, keep yourself warm when measuring your heart rate.
- Smoking or consuming alcohol before taking measurements may cause your heart rate to be different from your normal heart rate.
- Do not talk, yawn, or breathe deeply while taking heart rate measurements. Doing so may cause your heart rate to be recorded inaccurately.
- Heart rate measurements may vary depending on the measurement method and the environment they are taken in.
- If the heart rate sensor is not working, check the Gear's position on your wrist and make sure nothing is obstructing the sensor. If the heart rate sensor continues to have the same problem, visit a Samsung Service Centre.

Measuring your heart rate

- 1 Tap **S Health** on the Apps screen.
- 2 Rotate the bezel clockwise and open the heart rate tracker screen.
- 3 Tap  to begin measuring your heart rate.
After a moment, your current heart rate will be displayed on the screen.
- 4 Select a status tag for your status to the measured heart rate.
The Gear displays information about your heart rate in relation to your selected tag.

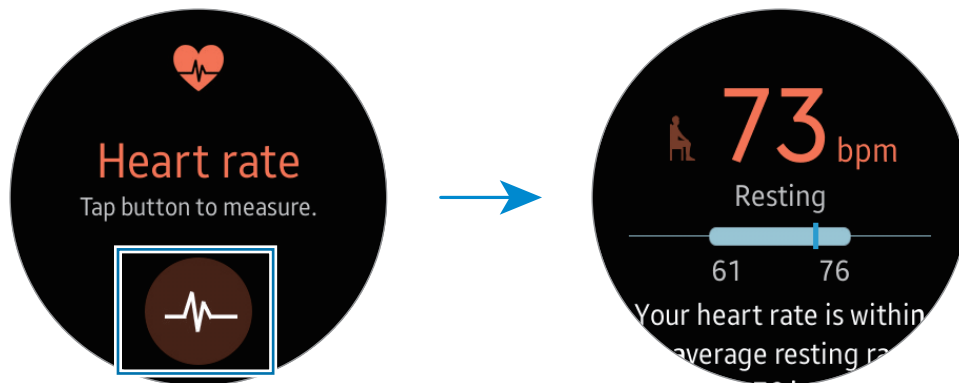

Tap the screen to view a graph of your records. To view records by hour, rotate the bezel.

Tracking your heart rate

The Gear can automatically measure and track your heart rate. Your Gear will measure your heart rate at regular intervals. This feature may not function properly while you are moving. To change the measuring interval, rotate the bezel clockwise and open the settings screen. Then, tap  → **Auto HR**.

Water tracker

Record and track how many glasses of water you drink.

- 1 Tap **S Health** on the Apps screen.
- 2 Rotate the bezel clockwise and open the water tracker screen.



- 3 Tap **+** when you drink a glass of water.

If you accidentally added an incorrect value, you can fix it in the S Health app on your mobile device.

Tap the screen to view a graph of your records. To view records by day, rotate the bezel.

Caffeine tracker

Record and track how many cups of coffee you drink.

- 1 Tap **S Health** on the Apps screen.
- 2 Rotate the bezel clockwise and open the caffeine tracker screen.



3 Tap when you drink a cup of coffee.

If you accidentally added an incorrect value, you can fix it in the S Health app on your mobile device.

Tap the screen to view a graph of your records. To view records by day, rotate the bezel.

Additional information

- The purpose for such data collection is limited to providing the service that you have requested, including providing additional information to enhance your wellness, back up/sync data, data analysis and statistics or to develop and provide better services. (But if you sign in to your Samsung account from S Health, your data may be saved on the server for data backup purposes.) Personal information may be stored until the completion of such purposes. To delete any data you have shared with social networks or transferred to storage devices, you must delete them separately.
 - You assume full responsibility for the inappropriate use of data shared on social networks or transmitted to others. Use caution when sharing your personal data with others.
 - If the Gear is connected to a mobile device, verify the communication protocol to confirm proper operation. If you use a wireless connection, such as Bluetooth, the Gear may be affected by electronic interference from other devices. Avoid using the Gear near other devices that transmit radio waves.
 - The content used in the S Health app may vary depending on the software version of the app. The services provided with the app are subject to change or the cancellation of support without prior notice.
 - Available S Health functions and services may vary depending on the local laws and regulations in your region.
 - Some functions of S Health may not be provided depending on your region.
 - S Health functions are intended for fitness and informational purposes only and is not intended for use in the diagnosis of disease or other conditions, or in the cure, mitigation, treatment, or prevention of disease.
-  • Measured distance may differ from the actual distance due to uneven strides, walking in place, and pacing around.
- Only records from the past thirty days are saved. You can view previous data on the mobile device where the S Health app is installed.

Running

Running records your exercising by tracking your distance, pace, and time. Check your monthly records and compare them with your friends.

Starting Running

You must download and install **Running** on the mobile device to use this app on the Gear.

Gear

- 1 On the Apps screen, tap **Running**.
The mobile device will display a screen that prompts you to download and install **Running**.

Mobile device

- 2 Follow the on-screen instructions to install **Running**.
- 3 Launch **Running**, tap **GET STARTED** → , enter your email address and password, and then tap **LOG IN** → **DONE**.



Starting to exercise

Gear

- 1 On the Apps screen, tap **Running**.
- 2 Tap .
- 3 Set your music, heart rate measurement, and encouragement preferences for your activity.

- 4 When you are finished, the Gear displays the Running main screen and starts to recording your exercise.

To view music playback controls while exercising, rotate the bezel anticlockwise.

- 5 When you are finished exercising, tap  →  → .

To view your exercise records for this month, rotate the bezel anticlockwise on the Running main screen.

To compare your exercise records with friends, rotate the bezel clockwise on the Running main screen. You can add your friends to compete with them.

Schedule

View the events scheduled on the mobile device.

- 1 Tap **Schedule** on the Apps screen.
- 2 Tap anywhere on the monthly calendar.
The current day's events list will be shown.
- 3 To view upcoming events, rotate the bezel to clockwise.

S Voice

Introduction

Perform various tasks simply by speaking.



Make sure the Gear's microphone is not obstructed when you are speaking into it.

Setting a wake-up command

You can launch **S Voice** using your own wake-up command. You can only use this feature when your Gear's screen is turned on.

When launching **S Voice** for the first time, tap ✓ → **START** and set your own wake-up command.

To change the wake-up command, tap ⋮, rotate the bezel to **Change wake-up command**, and then tap **Change wake-up command**. Then, tap ✓ → **START** and follow the on-screen instructions.

Using S Voice

1 Say the preset wake-up command. Alternatively, tap **S Voice** on the Apps screen.

When **S Voice** is launched, the Gear begins voice recognition.



This app may not be available depending on the region or service provider.



2 Say a voice command.

If the Gear recognises the command, the Gear will perform the corresponding action.

To repeat a voice command or say a different command, tap .

Tips for better voice recognition

- Speak clearly.
- Speak in quiet places.
- Do not use offensive or slang words.
- Avoid speaking in dialectal accents.

The Gear may not recognise your commands or may perform unwanted commands depending on your surroundings or how you speak.

Setting the language

On the Apps screen, tap **S Voice** →  → **Language**, and then select a language.



The selected language is applied to **S Voice** only, not to the language displayed on the Gear.

Weather

View weather information on the Gear for locations set on the mobile device when the devices are connected.

Tap **Weather** on the Apps screen.

To view the current day's weather information, tap the screen and rotate the bezel.

To add other cities' weather information, rotate the bezel clockwise.



When your Gear and mobile device are connected, this feature uses your mobile device's location information. If the mobile device's location feature is not activated, it is automatically activated.



Alarm

Setting alarms

- 1 Tap **Alarm** on the Apps screen.
- 2 Tap **Add alarm**.
If you have a saved alarm, tap **ADD** on the alarms list.
- 3 Set the alarm time by rotating the bezel and tap **NEXT**.
- 4 Select the days for the alarm to repeat and tap **SAVE**.
The saved alarm is added to the alarms list.

On the alarms list, tap  to activate the alarm or tap  to deactivate the alarm.

Stopping alarms

Drag  to the right to stop an alarm. If you want to use the snooze function, drag  to the left to repeat the alarm after 5 minutes.

Deleting alarms

In the alarms list, tap and hold an alarm, and then tap **DELETE**.

Timer

- 1 Tap **Timer** on the Apps screen.
- 2 Set the duration, and then tap **START**.
- 3 Drag  to the right when the timer goes off.

Stopwatch

- 1 Tap **Stopwatch** on the Apps screen.
- 2 Tap **START** to time an event.
To record lap times while timing an event, tap **LAP**.
- 3 Tap **STOP** to stop timing.
To restart the timing, tap **RESUME**.
To clear lap times, tap **RESET**.
To view the stopwatch log, swipe upwards from the bottom edge of the screen.

World Clock

Creating clocks

- 1 Tap **World Clock** on the Apps screen.
- 2 Tap **Add city**.
If you have a saved world clock, tap **ADD** on the clocks list.
- 3 Rotate the bezel to select a time zone on the globe.
You can also tap **ALL CITIES** and search for a city or select a city from the list.

Deleting clocks

On the clocks list, tap and hold a clock, and then tap **DELETE**.

Bloomberg

View the latest article summaries and stock indexes from Bloomberg.

Tap **Bloomberg** on the Apps screen.



This app may not be available depending on the region or service provider.

Select a category and view the article summaries or stock indexes. To read the full article or view details for the index on your mobile device, tap  → **Show on phone**.

CNN

Read the latest articles from CNN on your Gear.





This app may not be available depending on the region or service provider.

- 1 Tap **CNN** on the Apps screen.
- 2 Rotate the bezel to select a category.
- 3 Scroll up or down in the article list and tap an article to read it.
To read the full article, tap  and read it on your mobile device.

News Briefing

View the latest articles in various categories. You can catch up on news categories that interest you.

- 1 Tap **News Briefing** on the Apps screen.
- 2 Rotate the bezel to select an article from a specific category.
To edit categories, tap ; rotate the bezel to **Select topic**, tap **Select topic**, and then tick categories.
- 3 Tap an article to read it.
To read the full article, tap  and read it on your mobile device.

Music Player

Introduction

Listen to music saved in the Gear and in the mobile device.

Playing music

Tap **Music Player** on the Apps screen.

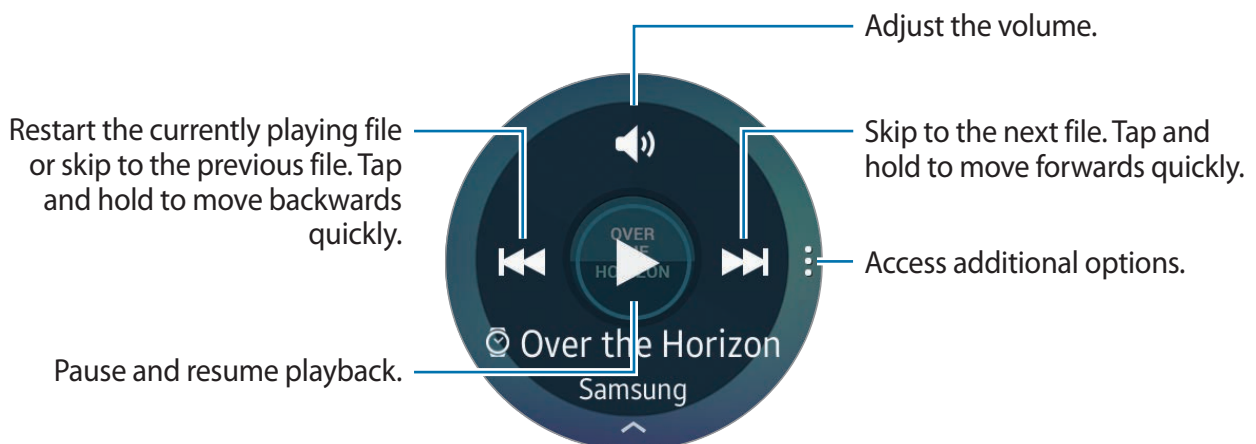

To listen to music saved in your Gear, you must connect with a Bluetooth headset.

To open the playlist, swipe upwards from the bottom edge of the screen.



Playing music on your mobile device

When you select a mobile device to play music from, you can control playback of the music with your Gear. The music will be played from your mobile device.

- 1 Tap **Music Player**.
- 2 Tap , rotate the bezel to **Play music from**, and then tap **Play music from**.
- 3 Tap .

The music will be played on your mobile device and the Gear will display the music controller screen.

Importing music

Import music saved in your device to your Gear.

- 1 On the Apps screen of the mobile device, tap **Samsung Gear**.
- 2 Tap **Send content to Gear**.
- 3 Tap **Select tracks**.
- 4 Select files and tap **DONE**.

To sync music in your mobile device with your Gear, open the Apps screen of the mobile device and tap **Samsung Gear** → **Send content to Gear**. Tap the **Auto sync** switch under **Music**, tap **Playlists to sync**, and then select playlists to export to the Gear. The selected playlists will be synced while the Gear is charging.

Gallery

Introduction

View and manage images stored in the Gear.

Viewing images

- 1 Tap **Gallery** on the Apps screen.
- 2 Rotate the bezel to scroll through the image list and select an image.

Zooming in or out

While viewing an image, double-tap the image to zoom in or out.

When the image is zoomed in, you can also view the rest of the image outside the circular display.

Deleting images

- 1 Tap **Gallery** on the Apps screen.
- 2 Tap an image.
- 3 Tap and hold an image to delete.
- 4 Rotate the bezel and select any images you want to delete.
- 5 Tap **DELETE** → ✓.

Importing and exporting images

Exporting images to your mobile device

- 1 Tap **Gallery** on the Apps screen.
- 2 Tap an image.
- 3 Tap and hold the image to export.
- 4 Rotate the bezel and select any images to export.
- 5 Tap , rotate the bezel to **Send to phone**, and then tap **Send to phone**.

Importing images from your mobile device

- 1 On the Apps screen of the mobile device, tap **Samsung Gear**.
- 2 Tap **Send content to Gear**.
- 3 Tap **Select photos**.
- 4 Select files and tap **DONE**.

To sync images in your mobile device with your Gear, open the Apps screen of the mobile device and tap **Samsung Gear** → **Send content to Gear**. Tap the **Auto sync** switch under **Photo**, tap **Albums to sync**, and then select albums to import to the Gear. The selected albums will be synced while the Gear is charging.

Buddy

Manage buddies on your Gear. You can select buddies from contacts saved in your mobile device. If you select a contact as a buddy, you can quickly initiate calls or send messages from the Gear.

Tap **Buddy** on the Apps screen.

Select a buddy and initiate a call or send a message.

Adding buddies

Rotate the bezel to **Add to list** and tap **Add to list**. Then, on your mobile device, select contacts you want to add.

Email

View emails received on the mobile device and reply to them.

Reading emails

1 On the Apps screen, tap **Email**.

2 Select an email to open the email screen.

To view an email on the mobile device, tap  → **Show on phone**.

To reply to a message, tap  and enter your message.



You may not be able to reply emails depending on the mobile device that you connect to the Gear.

Find My Phone

If you misplace the mobile device, the Gear can help you find it.

1 Tap **Find My Phone** on the Apps screen.

2 Tap .

The mobile device emits sounds and turns on the screen.

Drag  outside the large circle on the mobile device, or tap  on the Gear.

Viewing the location of your mobile device

Tap  → **Locate phone**.

The Gear will display your mobile device's location.

Maps

Find your location on the map, search for locations, and view location information for various places.

On the Apps screen, tap **Maps**.

To view your current location, tap .

To search for a location, tap the screen and then tap .



To search for a route, tap the screen and tap . If you want to view the detailed route, download the suggested app on your mobile device.

Voice Memo

Introduction

Use this app to record or play voice memos.

Recording voice memos

- 1 Tap **Voice Memo** on the Apps screen.
- 2 Tap  to start recording. Speak into the microphone.
Tap  to pause recording.

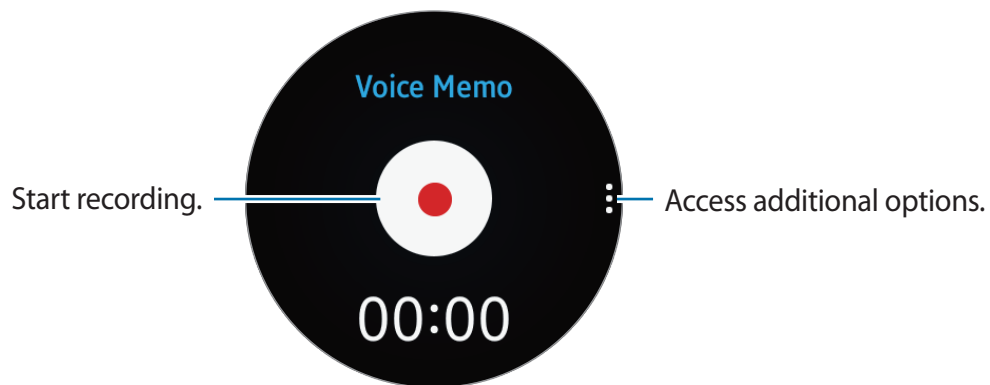

- 3 Tap  to finish recording.

The voice memo is saved in the Gear and the mobile device simultaneously.

To save the voice memo only in the Gear, on the Apps screen of the mobile device, tap **Samsung Gear** → **Settings** → **Individual app settings** → **Voice Memo** → **Auto transfer**, and then tap the switch.

Saving as a text memo

While voice recording, the Gear recognises the voice memo, changes into text and saves it.

To change the recognition language, tap , rotate the bezel to **Language**, and then tap **Language**.

To deactivate the feature, tap , rotate the bezel to **Speech-to-text**, and then tap **Speech-to-text**.

Settings

Introduction

Customise settings for functions and apps. You can make your Gear more personalised by configuring various setting options.

Tap **Settings** on the Apps screen.

Display

Change the display settings.

On the Settings screen, tap **Display**.

- **Watch faces:** Select a watch type.
- **Watch always on:** Set the Gear to display a watch when the screen is turned off.
- **Notification indicator:** Set the Gear to display an orange dot on the Watch screen to alert you to notifications that you have not checked.
- **Brightness:** Adjust the brightness for the display.
- **Screen timeout:** Set the length of time the Gear waits before turning off the display's backlight.
- **Font:** Change the font type and size.

Vibration

Change the vibration settings.

On the Settings screen, tap **Vibration**.

- **Intensity:** Adjust the intensity of the vibration notification.
- **Long buzz:** Increase the duration of the vibration to notice alerts more easily.

Device

Change the Gear's interaction settings.

On the Settings screen, tap **Device**.

- **Double press Home key:** Select an action to perform when you press the Gear's Home key twice.
- **Wake-up gesture:** Set the Gear to turn on the screen when you raise your wrist that is wearing the Gear.

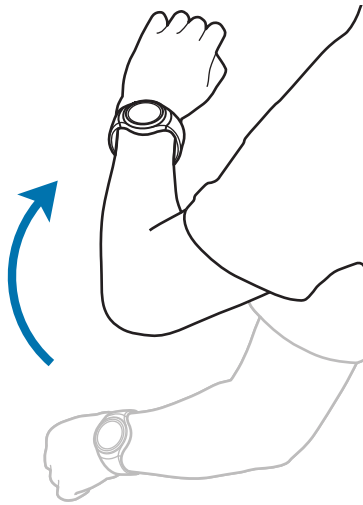

- **Auto open apps:** Set the Gear to automatically open an app when it is highlighted.

Call

Change the call feature settings.

On the Settings screen, tap **Call**.

- **Voice answer:** Set the Gear to answer or reject calls using voice commands.

Connections

Bluetooth

Use Bluetooth to exchange data or media files with other Bluetooth-enabled devices.



- Samsung is not responsible for the loss, interception, or misuse of data sent or received via Bluetooth.
- Always ensure that you share and receive data with devices that are trusted and properly secured. If there are obstacles between the devices, the operating distance may be reduced.
- Some devices, especially those that are not tested or approved by the Bluetooth SIG, may be incompatible with your device.
- Do not use the Bluetooth feature for illegal purposes (for example, pirating copies of files or illegally tapping communications for commercial purposes).
Samsung is not responsible for the repercussion of illegal use of the Bluetooth feature.

On the Settings screen, tap **Connections** → **Bluetooth**.

- **Bluetooth:** Turn the Bluetooth feature on or off.
- **BT headset:** Search for Bluetooth headsets and connect them to the Gear.



The headset can be only used when playing music on the Gear.

Wi-Fi

Activate the Wi-Fi feature to connect to a Wi-Fi network.

On the Settings screen, tap **Connections** → **Wi-Fi**, and then tap **Wi-Fi** switch to activate it.



Turn off Wi-Fi to save the battery when not in use.

Connecting to a Wi-Fi network

This feature is available when the Gear is not connected to the mobile device via Bluetooth.

- 1 On the Settings screen, tap **Connections** → **Wi-Fi**, and then tap **Wi-Fi** switch to activate it.
- 2 Tap **Wi-Fi networks** → **SCAN**.
- 3 Select a network from the Wi-Fi networks list.
Networks that require a password appear with a lock icon.
- 4 Tap **CONNECT**.



- Once the Gear connects to a Wi-Fi network, the Gear will reconnect to that network each time it is available without requiring a password. To prevent the Gear connecting to the network automatically, select it from the list of networks and tap **FORGET**.
- If you cannot connect to a Wi-Fi network properly, restart your device's Wi-Fi feature or the wireless router.

NFC

The Gear allows you to make payments and buy tickets for transportation or events after downloading the required apps.

On the Settings screen, tap **Connections** → **NFC**.



The Gear contains a built-in NFC antenna. Handle the Gear carefully to avoid damaging the NFC antenna.

- **NFC:** Activate the NFC feature to link your Gear to your credit or debit card.
- **Tap and pay:** Set the default payment app for mobile payments.

Making payments with the NFC feature

Before you can use the NFC feature to make payments, you must register for the mobile payment service. To register or get more information about the service, contact your service provider.

- 1 On the Settings screen, tap **Connections** → **NFC** and then tap the **NFC** switch to activate it.
- 2 Touch the NFC antenna area at the top of the Gear's touchscreen to the NFC card reader.

To set the default payment app, open the settings screen and tap **Connections** → **NFC** → **Tap and pay**, and then select an app.



The payment services list may not include all available payment apps.

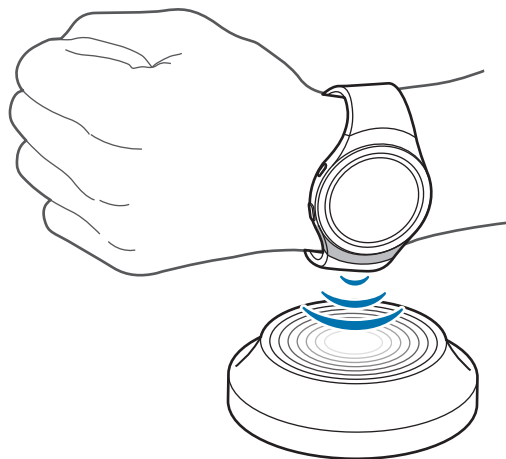

Alerts

Set the Gear to vibrate when it is disconnected from your mobile device.

On the Settings screen, tap **Connections** → **Alerts**.

Screen lock

Set the Gear to use the screen lock feature when you are not wearing it.

On the Settings screen, tap **Screen lock**.

- **Screen lock:** Activate or deactivate the screen lock feature. Refer to [Setting the screen lock](#) for more information.
- **Help:** View help information for using the screen lock feature.

Input

Default keyboard

Select a default keyboard type for text input.

On the Settings screen, tap **Input** → **Default keyboard**.

Keyboard settings

Change the Samsung keyboard settings.

On the Settings screen, tap **Input** → **Keyboard settings** → **Samsung keyboard**.

- **English (UK):** Select a default keyboard layout.
- **Select input languages:** Select languages for text input.
- **Check for updates:** Set the Gear to check for and download the latest version of the Samsung keyboard.
- **Smart typing:**
 - **Predictive text:** Activate predictive text mode to predict words based on your input and show word suggestions.
 - **Auto replace:** Set the Gear to correct misspelled and incomplete words by tapping the space bar.

- **Auto capitalise:** Set the Gear to automatically capitalise the first character after a final punctuation mark, such as a full stop, question mark, or exclamation mark.
- **Auto spacing:** Set the Gear to automatically insert a space between words.
- **Auto punctuate:** Set the Gear to insert a full stop when you double-tap the space bar.
- **Key-tap feedback:**
 - **Vibration:** Set the Gear to vibrate when a key is tapped.
- **Reset settings:** Reset Samsung keyboard settings.

Power saving

Activate power saving mode to save battery power by limiting the Gear's functions.

- Displays colours on the screen as grey tones.
- Deactivates features, excluding phone, messages, and notifications.
- Deactivates the Wi-Fi feature.
- Limits the performance of the Gear's CPU.

On the Settings screen, tap **Power saving** → ✓. Alternatively, press and hold the Power key and tap **Power saving** → ✓.

To deactivate this mode, tap **OFF** → ✓.

Gear info

View the Gear's information.

On the Settings screen, tap **Gear info**.

- **About device:** Access information about the Gear.
- **Report diagnostic and usage info:** Set the Gear to automatically send the device's diagnostic and usage information to Samsung.
- **Reset Gear:**
 - **Light reset:** Delete data except media files and personal data.
 - **Factory reset:** Reset settings to the factory default values and delete all data.
- **Debugging:** Activate or deactivate USB debugging mode when developing apps for the Gear.

Samsung Gear

Introduction

To connect your Gear to a mobile device, you must install the Samsung Gear app on your mobile device. Using the Samsung Gear app, you can customise your Gear's settings.

Tap **Samsung Gear** on the Apps screen of the mobile device.

If it is the first time connecting your Gear and mobile device, refer to [Connecting the Gear to a mobile device](#) for more information.



Some features may not be available depending on the type of connected mobile device.

Disconnecting the Gear

On the Apps screen of the mobile device, tap **Samsung Gear**.

Tap **MORE** → **Disconnect** → **DISCONNECT**. The Gear will disconnect from your mobile device.

To reconnect the Gear, tap **CONNECT**.

Connecting a new Gear

If you are currently using another Gear, you can disconnect it from the mobile device and connect a new one.

On the Apps screen of the mobile device, tap **Samsung Gear**.

Tap **MORE** → **Connect new Gear** and then select a new Gear.

Viewing the user manual

View the user manual to learn how to use your Gear.

On the Apps screen of the mobile device, tap **Samsung Gear** → **MORE** → **User manual**.

Watch faces

You can change the type of watch to be displayed on the Watch screen.

On the Apps screen of the mobile device, tap **Samsung Gear** → **Watch faces** and select a desired watch type. The watch face you selected will be applied on the Watch screen.

Tap **STYLISE** to select background and items to display on the watch face.

Notifications

Change settings for the notification feature. Stay up to date with a variety of events, such as new messages received on the mobile device.

On the Apps screen of the mobile device, tap **Samsung Gear** → **Notifications**, tap the switch to activate it, and then activate items.

- **Manage notifications:** Select apps on the mobile device to send notifications to the Gear.
- **Limit notifications:** Set the Gear to block all notifications, except for alarms, that are received when the mobile device's screen is turned on.
- **Turn screen on:** Set the Gear to turn on the screen when the notification is received.
- **Auto show details:** Set the Gear to show details for notifications when they are received.
- **Notification indicator:** Set the Gear to display an orange dot on the Watch screen to alert you to notifications that you have not checked.
- **Smart relay:** Set the mobile device to display notification information that is displayed on the Gear when you pick up the mobile device.



- This feature is only available when the Gear's screen is turned on.
- Some mobile devices do not support this feature.
- The mobile device must be unlocked first to view details when the screen is locked.

Apps layout

Customise the Gear's Apps screen. You can select and rearrange apps.

On the Apps screen of the mobile device, tap **Samsung Gear** → **Apps layout**.

Uninstalling apps

Tap **UNINSTALL** and select apps to remove from the Gear.

Reordering apps

Tap  next to an app and drag it up or down to another position.

Send content to Gear

Transfer saved audio or image files from your mobile device to your Gear.

On the Apps screen of the mobile device, tap **Samsung Gear** → **Send content to Gear**.



When the Gear does not have enough available memory, it deletes files that you have not set as your favourites in order from oldest to newest.

- **Select tracks:** Select audio files and manually send them from the mobile device to the Gear.
- **Auto sync:** Set the device to sync audio files with the Gear while the Gear is charging.
- **Playlists to sync:** Select a playlist to sync with the Gear.
- **Select photos:** Select images and manually send them from the mobile device to the Gear.
- **Auto sync:** Set the device to sync images with the Gear while the Gear is charging.
- **Albums to sync:** Select an image folder to sync with the Gear.

Settings

Quick messages

Edit or add templates used for replying to messages.

- 1 On the Apps screen of the mobile device, tap **Samsung Gear** → **Settings** → **Quick messages**.
- 2 Tap **General messages** or **Call-reject messages**.
- 3 Select a template to edit.
To create additional templates, enter text in the input field and then tap **+**.
- 4 Edit the template and tap **SAVE**.

Individual app settings

You can manage some app settings installed on the Gear.

On the Apps screen of the mobile device, tap **Samsung Gear** → **Settings** → **Individual app settings**.

Select an app and configure the settings.

Auto update downloaded apps

Change the settings to automatically update the downloaded apps on your Gear.

On the Apps screen of the mobile device, tap **Samsung Gear** → **Settings** → **Auto update downloaded apps**.

Select a download option.

Double press Home key

Set an action to be performed when you press the Gear's Home key twice.

On the Apps screen of the mobile device, tap **Samsung Gear** → **Settings** → **Double press Home key**, and then select an option.

Gear connection

Customise your Gear's wireless connection settings.

On the Apps screen of the mobile device, tap **Samsung Gear** → **Settings** → **Gear connection**.

- **Remote connection:** Set the Gear to remotely connect to the mobile device when a Bluetooth connection between the devices is not available.
- **Sync Wi-Fi profiles:** Set the device to sync the list of saved Wi-Fi networks with your Gear.

Send SOS messages

Set the device to send help messages by pressing the Gear's Home key three times.

In an emergency situation, quickly press the Gear's Home key three times. The device sends messages to your primary contacts. The messages include your location information. You can also send sound recordings along with the message to the recipients.

- 1 On the Apps screen of the mobile device, tap **Samsung Gear** → **Settings** → **Send SOS messages**, and then tap the switch to activate it.
- 2 Follow the on-screen instructions to add primary contacts if you have not already done so.
- 3 To send help messages with audio recordings, tap the **Attach audio recording** switch to activate it.



Some mobile devices do not support this feature.

Adding primary contacts

On the Apps screen of the mobile device, tap **Samsung Gear** → **Settings** → **Send SOS messages** → **Send messages to**.

Tap **ADD** → **Create contact** and enter contact information or tap **Select from contacts** to add an existing contact as a primary contact.

Back up and restore

Back up the stored data on the Gear or restore backup data.

On the Apps screen of the mobile device, tap **Samsung Gear** → **Settings** → **Back up and restore** → **Back up data** or **Restore data**.

About Gear

Access information about the Gear.

On the Apps screen of the mobile device, tap **Samsung Gear** → **Settings** → **About Gear**.

- **Update Gear software:** Update the Gear to the latest software.
- **Gear storage:** View your Gear's memory information.



The actual available capacity of the internal memory is less than the specified capacity because the operating system and default apps occupy part of the memory. The available capacity may change when you update the device.

- **Legal information:** View the legal information for the Gear.
- **Unknown sources:** Set the Gear to allow the installation of apps from unknown sources.
- **Device name:** Change the Gear's name.

App version

View version information of the Samsung Gear app.

On the Apps screen of the mobile device, tap **Samsung Gear** → **Settings** → **App version**.

Find my Gear

Remotely control your Gear when it is lost or misplaced.

On the Apps screen of the mobile device, tap **Samsung Gear** → **Find my Gear**.



- **Reactivation lock:** Set the Gear to require your Samsung account information after the device has been reset. This prevents others from reactivating your device if it is lost or stolen.
- **Control remotely:**
 - **Lock Gear:** Remotely lock the Gear to prevent unauthorised access. This feature can be activated when the Bluetooth connection between the Gear and mobile device ends while a remote connection is activated.
 - **Reset Gear:** Remotely delete all personal information stored in the Gear. After the Gear is reset, you cannot restore the information or use the Find my Gear feature.

Finding your Gear

If you misplace the Gear, find it with this feature.

1 On the Apps screen of the mobile device, tap **Samsung Gear** → **Find my Gear**.

2 Tap .

The Gear will vibrate and the screen will turn on. Drag  to the right on the Gear, or tap  on the mobile device.

Samsung Gear Apps

You can download apps for your Gear from **Samsung Gear Apps**.

On the Apps screen of the mobile device, tap **Samsung Gear** → **Samsung Gear Apps**.

Browse by category and select an app to download.

Appendix

Troubleshooting

Before contacting a Samsung Service Centre, please attempt the following solutions. Some situations may not apply to your Gear.

Your Gear does not turn on

When the battery is completely discharged, your Gear will not turn on. Charge the battery completely before turning on the Gear.

Your Gear displays network or service error messages

- When you are in areas with weak signals or poor reception, you may lose reception. Move to another area and try again. While moving, error messages may appear repeatedly.
- You cannot access some options without a subscription. For more information, contact your service provider.

The touchscreen responds slowly or improperly

- If you attach a screen protector or optional accessories to the touchscreen, the touchscreen may not function properly.
- If you are wearing gloves, if your hands are not clean while touching the touchscreen, or if you tap the screen with sharp objects or your fingertips, the touchscreen may malfunction.
- The touchscreen may malfunction in humid conditions or when exposed to water.
- Restart your Gear to clear any temporary software bugs.
- Ensure that your Gear software is updated to the latest version.
- If the touchscreen is scratched or damaged, visit a Samsung Service Centre.

Your Gear freezes or has fatal errors

If your Gear freezes or hangs, you may need to close apps or turn off the Gear and turn it on again. If your Gear is frozen and unresponsive, press and hold the Home key for more than 7 seconds to reset.

If this does not solve the problem, perform a factory data reset. On the Apps screen, tap **Settings** → **Gear info** → **Reset Gear** → **Factory reset**. Before performing the factory data reset, remember to make backup copies of all important data stored on the Gear.

If the problem is still not resolved, contact a Samsung Service Centre.

Another Bluetooth device cannot locate your Gear

- Ensure that the Bluetooth wireless feature is activated on your Gear.
- Reset your Gear and try again.
- Ensure that your Gear and the other Bluetooth device are within the Bluetooth connection range (10 m). The distance may vary depending on the environment the devices are used in.

If the tips above do not solve the problem, contact a Samsung Service Centre.

A Bluetooth connection is not established or your Gear and the mobile device are disconnected

- Ensure that the Bluetooth feature on both devices is activated.
- Ensure there are no obstacles, such as walls or electrical equipment, between the devices.
- Ensure that the latest version of the Samsung Gear app is installed on the mobile device.
- Ensure that your Gear and the other Bluetooth device are within the Bluetooth connection range (10 m). The distance may vary depending on the environment the devices are used in.
- Restart both devices and launch the Samsung Gear app on the mobile device again.

The Internet is often disconnected

- Ensure that you are not blocking the Gear's antenna area.
- When you are in areas with weak signals or poor reception, you may lose reception. You may have connectivity problems due to issues with the service provider's base station. Move to another area and try again.
- When using the Gear while moving, wireless network services may be disabled due to issues with the service provider's network.

The battery icon is empty

Your battery is low. Charge the battery.

The battery does not charge properly (For Samsung-approved chargers)

- Ensure that you connect the Gear to the wireless charger dock and connect the dock to the charger properly.
- Visit a Samsung Service Centre and have the battery replaced.

The battery depletes faster than when first purchased

- When you expose the Gear or the battery to very cold or very hot temperatures, the useful charge may be reduced.
- Battery consumption increases when you use some apps.
- The battery is consumable and the useful charge will get shorter over time.

Your Gear is hot to the touch

When you use apps that require more power or use apps on your Gear for an extended period of time, your Gear may feel hot to the touch. This is normal and should not affect your Gear's lifespan or performance.

If the device overheats or feels hot for a prolonged period, do not use it for a while. If the device continues to overheat, contact a Samsung Service Centre.

Your Gear cannot find your current location

The Gear uses your mobile device's location information. GPS signals may be obstructed in some locations, such as indoors. Set the mobile device to use Wi-Fi to find your current location.

Data stored in the Gear has been lost

Always make backup copies of all important data stored in the Gear. Otherwise, you cannot restore data if it is corrupted or lost. Samsung is not responsible for the loss of data stored in the Gear.

A small gap appears around the outside of the Gear case

- This gap is a necessary manufacturing feature and some minor rocking or vibration of parts may occur.
- Over time, friction between parts may cause this gap to expand slightly.

Removing the battery

- To remove the battery, you **must** visit an authorised service centre with the provided instructions.
- For your safety, you **must not attempt to remove** the battery. If the battery is not properly removed, it may lead to damage to the battery and device, cause personal injury, and/or result in the device being unsafe.
- Samsung does not accept liability for any damage or loss (whether in contract or tort, including negligence) which may arise from failure to precisely follow these warnings and instructions, other than death or personal injury caused by Samsung's negligence.

- 1 Remove the strap from the Gear.
- 2 Remove the screws from the back of the Gear.
- 3 Remove the screen from the Gear's body using a flat edged tool.
- 4 Remove the circuit board by lifting it out of the Gear's body.
- 5 Remove the battery by pulling the battery connector at the right side of the Gear upwards.

Copyright

Copyright © 2015 Samsung Electronics

This manual is protected under international copyright laws.

No part of this manual may be reproduced, distributed, translated, or transmitted in any form or by any means, electronic or mechanical, including photocopying, recording, or storing in any information storage and retrieval system, without the prior written permission of Samsung Electronics.

Trademarks

- SAMSUNG and the SAMSUNG logo are registered trademarks of Samsung Electronics.
- Bluetooth® is a registered trademark of Bluetooth SIG, Inc. worldwide.
- Wi-Fi®, Wi-Fi Protected Setup™, Wi-Fi Direct™, Wi-Fi CERTIFIED™, and the Wi-Fi logo are registered trademarks of the Wi-Fi Alliance.
- All other trademarks and copyrights are the property of their respective owners.