

Operating Instructions Functional Manual

LCD Projector Commercial Use

Model No.	PT-VMZ71	PT-VMZ61
	PT-VMZ51	PT-VMZ51S
	PT-VMZ41	PT-VMW61
	PT-VMW51	

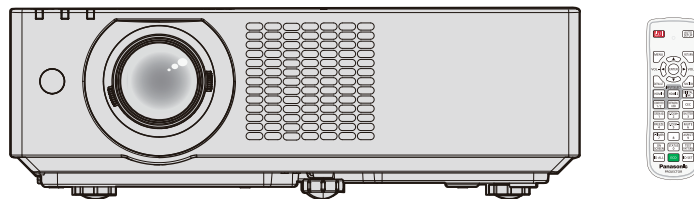

The remote control differs depending on projector models.

Thank you for purchasing this Panasonic product.

- The Operating Instructions correspond to the firmware's main version 2.02 and higher.
- This manual is common to all the models regardless of suffixes of the Model No.
 - for India
D: White model
 - for Taiwan
T: White model
 - for other countries or regions
With B: Black model (PT-VMZ71B and PT-VMZ61B only) Without B: White model
- Before operating this product, please read the instructions carefully, and save this manual for future use.
- Before using your projector, be sure to read "Read this first!" (➡ pages 4 to 15).



ENGLISH

DPQP1388ZC/X1

Contents

Read this first!4

Chapter 1 Preparation

Precautions for use	19
Intended use of the product.....	19
Cautions when transporting.....	19
Cautions when installing.....	19
Cautions when setting the projectors	20
Security	21
Notes regarding the wireless LAN	22
DIGITAL LINK.....	22
Application software supported by the projector ..	23
Storage.....	23
Disposal.....	23
Cautions on use	23
Accessories	25
Optional accessories	26
About your projector	27
Remote control.....	27
Projector body	29
Preparing the remote control	32
Inserting and removing batteries	32
When using the system with multiple projectors ..	32
Attaching the lens cap	33

Chapter 2 Getting Started

Setting up	35
Installation mode	35
Parts for ceiling mount (optional).....	36
Projected image and throw distance	36
Connecting	40
Before connecting	40
Connecting example: AV equipment	40
Connecting example: Computers	41
Connecting example: Using DIGITAL LINK.....	42

Chapter 3 Basic Operations

Switching on/off the projector	45
Connecting the power cord	45
Power indicator.....	45
Switching on the projector	47
When the initial setting screen is displayed.....	47
When the administrator account setting screen is displayed.....	49
Making adjustments and selections	51
Switching off the projector	52
Projecting	53
Selecting the image input for projection	53
Adjusting the focus, zoom, and lens shift.....	55
Adjusting adjustable feet	55

About lens shift adjustment range	56
Operating with the remote control	57
Using the shutter function.....	57
Using the mute function.....	57
Adjusting the volume	57
Using the freeze function.....	58
Using the on-screen display function	58
Using the auto setup function	58
Using the screen adjustment function	59
Using the digital zoom function	59
Switching the image aspect ratio.....	61
Using the presentation timer function.....	61
Using the FUNCTION button.....	61
Displaying internal test pattern	62
Using the status function	62
Using the ECO management function.....	62
Using the HDMI-CEC function.....	62
Setting the ID number on the remote control	63

Chapter 4 Settings

On-screen menu	65
Navigating through the menu	65
Main menu.....	66
Sub menu	67
[PICTURE] menu	69
[PICTURE MODE].....	69
[CONTRAST].....	69
[BRIGHTNESS]	69
[COLOR].....	70
[TINT]	70
[SHARPNESS]	70
[COLOR TEMPERATURE].....	70
[GAMMA].....	70
[ADVANCED MENU]	71
[DAYLIGHT VIEW].....	71
[DIGITAL CINEMA REALITY]	72
[DYNAMIC CONTRAST].....	72
[RGB/YC _B C _R] / [RGB/YP _B P _R].....	73
[RGB-SYSTEM].....	73
[POSITION] menu	74
[REALTIME KEYSTONE]	74
[SCREEN ADJUSTMENT]	74
[SHIFT].....	77
[DOT CLOCK].....	78
[CLOCK PHASE].....	78
[OVER SCAN]	79
[ASPECT].....	79
[FRAME LOCK]	79
[CLAMP POSITION].....	80
[LANGUAGE] menu	81
Switching the display language	81
[DISPLAY OPTION] menu	82

Contents

[ON-SCREEN DISPLAY]	82	Termination of the Memory Viewer	117
[HDMI SIGNAL LEVEL]	83	Projecting with NETWORK input	118
[DIGITAL LINK SIGNAL LEVEL]	83	Application that can be used	118
[SCREEN SETTING]	84	Connecting the device	118
[STARTUP LOGO]	84	Ending the connection with the device	118
[SHUTTER SETTING]	84	Network connection	119
[AUTO SETUP SETTING]	85	Connecting via wired LAN	119
[SIGNAL SEARCH]	85	Connecting with wireless LAN	121
[BACK COLOR]	85	About Presenter Light	125
[P-TIMER]	85	Web control function	126
[UNIFORMITY]	86	Computer that can be used for setting	126
[OTHER FUNCTIONS]	87	Accessing from the web browser	126
[PROJECTOR SETUP] menu	89	Using HDMI-CEC function	143
[STATUS]	89	Connecting a CEC-compatible device	143
[PROJECTOR ID]	89	Setting the projector and CEC-compatible device	143
[INITIAL START UP]	89	Operating the CEC-compatible device with the projector remote control	143
[PROJECTION METHOD]	90	About the link control	144
[ECO MANAGEMENT]	90		
[RS-232C]	93		
[FUNCTION BUTTON]	94		
[AUDIO SETTING]	94		
[TEST PATTERN]	96		
[FILTER COUNTER]	96		
[HDMI CEC]	97		
[INITIALIZE ALL]	99		
[SECURITY] menu	100		
[PASSWORD]	100		
[PASSWORD CHANGE]	100		
[TEXT DISPLAY]	101		
[TEXT CHANGE]	101		
[MENU LOCK]	101		
[MENU LOCK PASSWORD]	101		
[CONTROL DEVICE SETUP]	102		
[NETWORK] menu	103		
[ETHERNET TYPE]	103		
[DIGITAL LINK]	103		
[WIRED LAN]	105		
[PROJECTOR NAME]	106		
[NETWORK STATUS]	106		
[ADMINISTRATOR ACCOUNT]	107		
[NETWORK SECURITY]	110		
[NETWORK CONTROL]	110		
[PJLink]	111		
[MEMORY VIEWER]	112		
[INITIALIZE]	114		

Chapter 5 Operation of Function

Projecting with MEMORY VIEWER input	116
What you can project with the Memory Viewer function	116
Cautions on using USB Memory	116
Displaying the Memory Viewer screen	117
Playing the pictures	117
Executing the slide	117

Chapter 6 Maintenance

Light source and temperature indicators	146
When an indicator lights up	146
Maintenance/replacement	147
Before performing maintenance/replacement	147
Maintenance	147
Replacement	150
Troubleshooting	151
[SELF TEST] display	153

Chapter 7 Appendix

Technical information	155
Using the PJLink function	155
Control commands via LAN	157
<SERIAL IN> terminal	160
<COMPUTER 1 IN> terminal / <COMPUTER 2 IN> terminal pin assignments and signal names	163
Specifications	164
Dimensions	167
List of compatible signals	168
Precautions for attaching the Ceiling Mount Bracket	170
Index	171

Read this first!

WARNING: THIS APPARATUS MUST BE EARTHED.

WARNING: To prevent damage which may result in fire or shock hazard, do not expose this appliance to rain or moisture.
This device is not intended for use in the direct field of view at visual display workplaces. To avoid incommoding reflections at visual display workplaces this device must not be placed in the direct field of view.
The equipment is not intended for used at a video workstation in compliance BildscharbV.
The sound pressure level at the operator position is equal or less than 70 dB (A) according to ISO 7779.

WARNING:

1. Remove the plug from the mains socket when this unit is not in use for a prolonged period of time.
2. To prevent electric shock, do not remove cover. No user serviceable parts inside. Refer servicing to qualified service personnel.
3. Do not remove the earthing pin on the mains plug. This apparatus is equipped with a three prong earthing-type mains plug. This plug will only fit an earthing-type mains socket. This is a safety feature. If you are unable to insert the plug into the mains socket, contact an electrician. Do not defeat the purpose of the earthing plug.

WARNING:

This equipment is compliant with Class A of CISPR32.
In a residential environment this equipment may cause radio interference.

(for Taiwan)

WARNING:

This equipment complies with the Class A standard of CNS13438.
This is Class A information technology equipment that may cause radio frequency interference when used in a residential environment, in which the user will be required to take certain appropriate countermeasures.

CAUTION: To assure continued compliance, follow the attached installation instructions. This includes using the provided power cord and shielded interface cables when connecting to computer or peripheral devices. Also, any unauthorized changes or modifications to this equipment could void the user's authority to operate this device.

This is a device to project images onto a screen, etc., and is not intended for use as indoor lighting in a domestic environment.

Directive 2009/125/EC

WARNING: TO REDUCE THE RISK OF FIRE OR ELECTRIC SHOCK, DO NOT EXPOSE THIS PRODUCT TO RAIN OR MOISTURE.

WARNING: RISK OF ELECTRIC SHOCK. DO NOT OPEN.



Indicated on the projector



The lightning flash with arrowhead symbol, within an equilateral triangle, is intended to alert the user to the presence of uninsulated "dangerous voltage" within the product's enclosure that may be of sufficient magnitude to constitute a risk of electric shock to persons.



The exclamation point within an equilateral triangle is intended to alert the user to the presence of important operating and maintenance (servicing) instructions in the literature accompanying the product.

Read this first!

WARNING: Do not look at the light emitted from the lens while the projector is being used.
As with any bright source, do not stare into the direct beam, RG2 IEC 62471-5:2015.

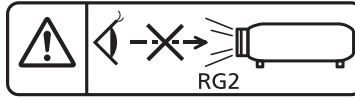

Indicated on the projector

WARNING: Do not place objects in front of the lens while the projector is being used.



Indicated on the projector

Notice on laser

This projector is the Class 1 laser product that complies with IEC/EN 60825-1:2014.

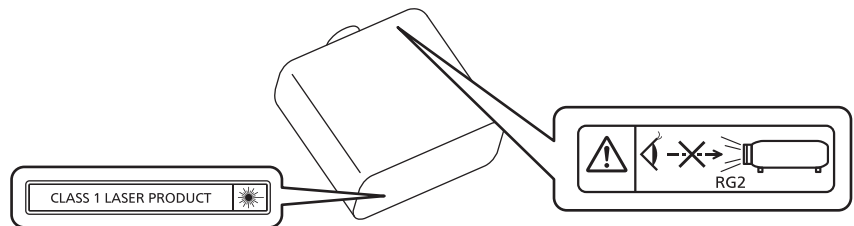

注意—打开时有 4 类激光辐射
避免眼或皮肤受到直射或散射辐射的照射
危険-開放時クラス 4 のレーザー放射
直接放射又は分散放射に眼又は皮膚を暴露させないこと
DANGER-CLASS 4 LASER RADIATION WHEN OPEN AVOID EYE OR
SKIN EXPOSURE TO DIRECT OR SCATTERED RADIATION
DANGER-RAYONNEMENT LASER DE CLASSE 4 - EN CAS D'OUVERTURE
EXPOSITION DANGEREUSE AU RAYONNEMENT DIRECT OU
DIFFUS DES YEUX OU DE LA PEAU

DPQT1359ZA

(Inside of product)

Notice on laser (for Taiwan)

This projector is the Class 1 laser product that complies with IEC/EN 60825-1:2014.

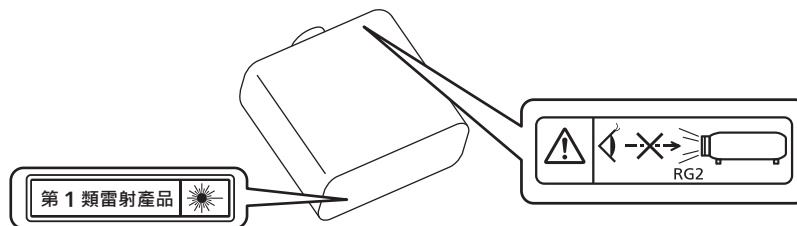

CAUTION: Use of controls or adjustments or performance of procedures other than those specified herein may result in hazardous radiation exposure.

CAUTION (North/Middle/South America)

Power Supply: This Projector is designed to operate on 100 V - 240 V, 50 Hz/60 Hz AC, house current only.

CAUTION: The AC power cord which is supplied with the projector as an accessory can only be used for power supplies up to 125 V. If you need to use higher voltages than this, you will need to obtain a separate 250 V power cord. If you use the accessory cord in such situations, fire may result.

CAUTION (North/Middle/South America/Taiwan)

This equipment is equipped with a three-pin grounding-type power plug. Do not remove the grounding pin on the power plug. This plug will only fit a grounding-type power outlet. This is a safety feature. If you are unable to insert the plug into the outlet, contact an electrician. Do not defeat the purpose of the grounding plug.

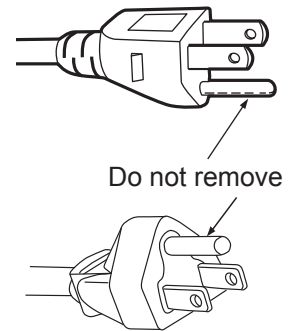

WARNING (USA and Canada)

- Not for use in a computer room as defined in the Standard for the Protection of Electronic Computer/Data Processing Equipment, ANSI/NFPA 75.
- For permanently connected equipment, a readily accessible disconnect device shall be incorporated in the building installation wiring.
- For pluggable equipment, the socket-outlet shall be installed near the equipment and shall be easily accessible.

NOTIFICATION (Canada)

This class A digital apparatus complies with Canadian ICES-003.

FCC NOTICE (USA)

Supplier's Declaration of Conformity

Model Number: PT-VMZ71, PT-VMZ71B, PT-VMZ61, PT-VMZ61B, PT-VMZ51, PT-VMZ51S, PT-VMW61, PT-VMW51
Trade Name: Panasonic
Responsible Party: Panasonic Corporation of North America
Address: Two Riverfront Plaza, Newark, NJ 07102-5490
General Contact: <http://www.panasonic.com/support>
Projector Contact: <https://panasonic.net/cns/projector/>

This device complies with Part 15 of the FCC Rules.

Operation is subject to the following two conditions:

(1) This device may not cause harmful interference, and (2) this device must accept any interference received, including interference that may cause undesired operation.

Caution:

This equipment has been tested and found to comply with the limits for a Class A digital device, pursuant to part 15 of the FCC Rules. These limits are designed to provide reasonable protection against harmful interference when the equipment is operated in a commercial environment. This equipment generates, uses, and can radiate radio frequency energy and, if not installed and used in accordance with the instruction manual, may cause harmful interference to radio communications. Operation of this equipment in a residential area is likely to cause harmful interference in which case the user will be required to correct the interference at his own expense.

FCC Warning:

To assure continued compliance, follow the attached installation instructions. This includes using the provided power cord and shielded interface cables when connecting to computer or peripheral devices. Also, any unauthorized changes or modifications to this equipment could void the user's authority to operate this device.

IMPORTANT: THE MOLDED PLUG

FOR YOUR SAFETY, PLEASE READ THE FOLLOWING TEXT CAREFULLY.

This appliance is supplied with a molded three pin mains plug for your safety and convenience. A 13 amp fuse is fitted in this plug. Should the fuse need to be replaced, please ensure that the replacement fuse has a rating of 13 amps and that it is approved by ASTA or BSI to BS1362.

Check for the ASTA mark  or the BSI mark  on the body of the fuse.

If the plug contains a removable fuse cover, you must ensure that it is refitted when the fuse is replaced. If you lose the fuse cover, the plug must not be used until a replacement cover is obtained. A replacement fuse cover can be purchased from an Authorized Service Center.

If the fitted molded plug is unsuitable for the mains socket in your home, then the fuse should be removed and the plug cut off and disposed of safely. There is a danger of severe electrical shock if the cut off plug is inserted into any 13 amp socket.

If a new plug is to be fitted, please observe the wiring code as shown below.

If in any doubt, please consult a qualified electrician.

WARNING: THIS APPLIANCE MUST BE EARTHED.

IMPORTANT: The wires in this mains lead are colored in accordance with the following code:

Green - and - Yellow:	Earth
Blue:	Neutral
Brown:	Live

As the colors of the wire in the mains lead of this appliance may not correspond with the colored markings identifying the terminals in your plug, proceed as follows.

The wire which is colored GREEN - AND - YELLOW must be connected to the terminal in the plug which is marked with the letter E or by the Earth symbol  or colored GREEN or GREEN - AND - YELLOW.

The wire which is colored BLUE must be connected to the terminal in the plug which is marked with the letter N or colored BLACK.

The wire which is colored BROWN must be connected to the terminal in the plug which is marked with the letter L or colored RED.

How to replace the fuse: Open the fuse compartment with a screwdriver and replace the fuse.

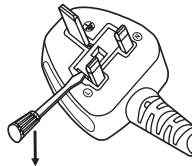

Read this first!

English	<p>Manufactured by: Panasonic Connect Co., Ltd. 4-1-62 Minoshima, Hakata-ku, Fukuoka 812-8531, Japan Importer: Panasonic Connect Europe GmbH Authorized Representative in EU: Panasonic Testing Centre Winsbergring 15, 22525 Hamburg, Germany</p> <p>Importer for UK: Panasonic Connect UK, a branch of Panasonic Connect Europe GmbH, Maxis 2, Western Road, Bracknell, Berkshire, RG12 1RT</p> 
Français	<p>Fabriqué par: Panasonic Connect Co., Ltd. 4-1-62 Minoshima, Hakata-ku, Fukuoka 812-8531, Japon Importateur: Panasonic Connect Europe GmbH Représentant autorisé dans l'UE: Panasonic Testing Centre Winsbergring 15, 22525 Hambourg, Allemagne</p>
Español	<p>Fabricado por: Panasonic Connect Co., Ltd. 4-1-62 Minoshima, Hakata-ku, Fukuoka 812-8531, Japón Importador: Panasonic Connect Europe GmbH Representante Autorizado para la UE: Panasonic Testing Centre Winsbergring 15, 22525 Hamburgo, Alemania</p>
Deutsch	<p>Hergestellt von: Panasonic Connect Co., Ltd. 4-1-62 Minoshima, Hakata-ku, Fukuoka 812-8531, Japan Importeur: Panasonic Connect Europe GmbH Vertretungsberechtigter in der EU: Panasonic Testing Centre Winsbergring 15, 22525 Hamburg, Deutschland</p>
Italiano	<p>Fabbricato da: Panasonic Connect Co., Ltd. 4-1-62 Minoshima, Hakata-ku, Fukuoka 812-8531, Giappone Importatore: Panasonic Connect Europe GmbH Rappresentante autorizzato nell'UE: Panasonic Testing Centre Winsbergring 15, 22525 Amburgo, Germania</p>
Български	<p>Производител: Panasonic Connect Co., Ltd. 4-1-62 Minoshima, Hakata-ku, Fukuoka 812-8531, Япония Вносител: Panasonic Connect Europe GmbH Упълномощен представител в ЕС: Panasonic Testing Centre Winsbergring 15, 22525 Hamburg, Германия</p>
Čeština	<p>Vyrobil: Panasonic Connect Co., Ltd. 4-1-62 Minoshima, Hakata-ku, Fukuoka 812-8531, Japonsko Dovozce: Panasonic Connect Europe GmbH Oprávněný zástupce v EU: Panasonic Testing Centre Winsbergring 15, 22525 Hamburk, Německo</p>
Dansk	<p>Fremstillet af: Panasonic Connect Co., Ltd. 4-1-62 Minoshima, Hakata-ku, Fukuoka 812-8531, Japan Importør: Panasonic Connect Europe GmbH Autoriseret repræsentant i EU: Panasonic Testing Centre Winsbergring 15, 22525 Hamburg, Tyskland</p>
Eesti	<p>Tootja: Panasonic Connect Co., Ltd. 4-1-62 Minoshima, Hakata-ku, Fukuoka 812-8531, Jaapan Maaletooja: Panasonic Connect Europe GmbH Volitatud esindaja ELis: Panasonic Testing Centre Winsbergring 15, 22525 Hamburg, Saksamaa</p>

Read this first!

Ελληνικά	<p>Κατασκευάστηκε από: Panasonic Connect Co., Ltd. 4-1-62 Minoshima, Hakata-ku, Fukuoka 812-8531, Ιαπωνία</p> <p>Εισαγωγέας: Panasonic Connect Europe GmbH</p> <p>Εξουσιοδοτημένος αντιπρόσωπος στην ΕΕ: Panasonic Testing Centre Winsbergring 15, 22525 Hamburg, Γερμανία</p>
Hrvatski	<p>Proizvodi: Panasonic Connect Co., Ltd. 4-1-62 Minoshima, Hakata-ku, Fukuoka 812-8531, Japan</p> <p>Uvoznik: Panasonic Connect Europe GmbH</p> <p>Oljaštveni zastupnik u EU-u: Panasonic Testing Centre Winsbergring 15, 22525 Hamburg, Njemačka</p>
Latviešu	<p>Ražotājs: Panasonic Connect Co., Ltd. 4-1-62 Minoshima, Hakata-ku, Fukuoka 812-8531, Japāna</p> <p>Importētājs: Panasonic Connect Europe GmbH</p> <p>Oficiālais pārstāvis ES: Panasonic Testing Centre Winsbergring 15, 22525 Hamburg, Vācija</p>
Lietuvių	<p>Gamintojas: Panasonic Connect Co., Ltd. 4-1-62 Minoshima, Hakata-ku, Fukuoka 812-8531, Japonija</p> <p>Importuotojas: Panasonic Connect Europe GmbH</p> <p>Įgaliojasis atstovas ES: Panasonic Testing Centre Winsbergring 15, 22525 Hamburgas, Vokietija</p>
Magyar	<p>Gyártotta: Panasonic Connect Co., Ltd. 4-1-62 Minoshima, Hakata-ku, Fukuoka 812-8531, Japán</p> <p>Importőr: Panasonic Connect Europe GmbH</p> <p>Hivatalos képviselő az EU-ban: Panasonic Testing Centre Winsbergring 15, 22525 Hamburg, Németország</p>
Nederlands	<p>Geproduceerd door: Panasonic Connect Co., Ltd. 4-1-62 Minoshima, Hakata-ku, Fukuoka 812-8531, Japan</p> <p>Importeur: Panasonic Connect Europe GmbH</p> <p>Bevoegde vertegenwoordiger in de EU: Panasonic Testing Centre Winsbergring 15, 22525 Hamburg, Duitsland</p>
Norsk	<p>Produsert av: Panasonic Connect Co., Ltd. 4-1-62 Minoshima, Hakata-ku, Fukuoka 812-8531, Japan</p> <p>Importør: Panasonic Connect Europe GmbH</p> <p>Autorisert representant i EU: Panasonic Testing Centre Winsbergring 15, 22525 Hamburg, Tyskland</p>
Polski	<p>Wyprodukowano przez: Panasonic Connect Co., Ltd. 4-1-62 Minoshima, Hakata-ku, Fukuoka 812-8531, Japonia</p> <p>Importer: Panasonic Connect Europe GmbH</p> <p>Upoważniony przedstawiciel w UE: Panasonic Testing Centre Winsbergring 15, 22525 Hamburg, Niemcy</p>
Português	<p>Fabricado por: Panasonic Connect Co., Ltd. 4-1-62 Minoshima, Hakata-ku, Fukuoka 812-8531, Japão</p> <p>Importador: Panasonic Connect Europe GmbH</p> <p>Representante Autorizado na UE: Panasonic Testing Centre Winsbergring 15, 22525 Hamburgo, Alemanha</p>
Română	<p>Fabricat de: Panasonic Connect Co., Ltd. 4-1-62 Minoshima, Hakata-ku, Fukuoka 812-8531, Japonia</p> <p>Importator: Panasonic Connect Europe GmbH</p> <p>Reprezentant autorizat în UE: Panasonic Testing Centre Winsbergring 15, 22525 Hamburg, Germania</p>

Read this first!

Slovenčina	Výrobca: Panasonic Connect Co., Ltd. 4-1-62 Minoshima, Hakata-ku, Fukuoka 812-8531, Japonsko Dovozca: Panasonic Connect Europe GmbH Autorizovaný zástupca v EÚ: Panasonic Testing Centre Winsbergring 15, 22525 Hamburg, Nemecko
Slovenščina	Proizvajaja: Panasonic Connect Co., Ltd. 4-1-62 Minoshima, Hakata-ku, Fukuoka 812-8531, Japonska Uvoznik: Panasonic Connect Europe GmbH Pooblaščenim zastopnik v EU: Panasonic Testing Centre Winsbergring 15, 22525 Hamburg, Nemčija
Suomi	Valmistaja: Panasonic Connect Co., Ltd. 4-1-62 Minoshima, Hakata-ku, Fukuoka 812-8531, Japani Maahantuoja: Panasonic Connect Europe GmbH Valtuutettu edustaja EU:ssa: Panasonic Testing Centre Winsbergring 15, 22525 Hampuri, Saksa
Svenska	Tillverkad av: Panasonic Connect Co., Ltd. 4-1-62 Minoshima, Hakata-ku, Fukuoka 812-8531, Japan Importör: Panasonic Connect Europe GmbH Auktoriserad representant i EU: Panasonic Testing Centre Winsbergring 15, 22525 Hamburg, Tyskland
Türkçe	Tarafından Üretilmiştir: Panasonic Connect Co., Ltd. 4-1-62 Minoshima, Hakata-ku, Fukuoka 812-8531, Japonya İthalatçı: Panasonic Connect Europe GmbH AB Yetkili Temsilcisi: Panasonic Testing Centre Winsbergring 15, 22525 Hamburg, Almanya

■ Hazard distance (IEC 62471-5:2015)

The distance from the projection lens surface, at which the emission reaches the Accessible Emission Limit (AEL) of risk group 2, is known as the hazard distance (HD) or safety distance. The area where the emission exceeds the Accessible Emission Limit of risk group 2 is called the hazard zone (HZ).

Within the hazard zone, never look into the light projected from the projector. The eyes may be damaged by direct irradiation even if you look at the light just for a moment. If you are outside the hazard zone, it is considered to be safe in all circumstances except deliberately staring into the light projected from the projector.

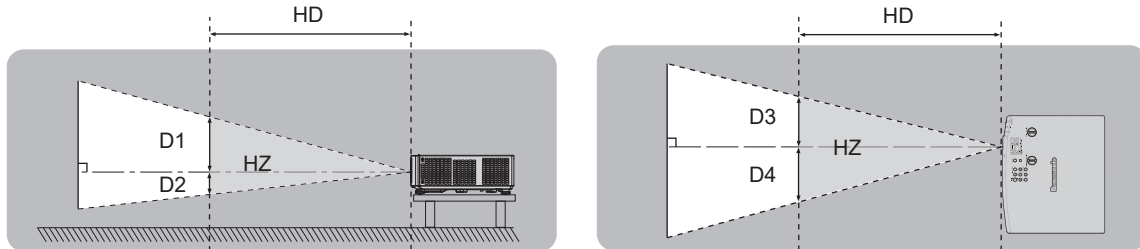

■ Risk group

The projector is categorized as the risk group 2 when the hazard distance is 1 m (39-3/8") or less. It is categorized as the risk group 3 when the hazard distance exceeds 1 m (39-3/8"), and it will be for professional use instead of consumer use.

In the case of risk group 3, there is a possibility of damaging the eyes by direct irradiation when looking into the projection light from inside the hazard zone even for a moment.

In the case of risk group 2, safe use without damaging the eyes is possible in all circumstances except deliberately staring into the light projected from the projector.

This projector is categorized as risk group 2.

WARNING:

■ POWER

The wall outlet or the circuit breaker shall be installed near the equipment and shall be easily accessible when problems occur. If the following problems occur, cut off the power supply immediately.

Continued use of the projector in these conditions will result in fire or electric shock, or will cause visual impairment.

- If foreign objects or water get inside the projector, cut off the power supply.
 - If the projector is dropped or the cabinet is broken, cut off the power supply.
 - If you notice smoke, strange smells or noise coming from the projector, cut off the power supply.
- Please contact an Authorized Service Center for repairs, and do not attempt to repair the projector yourself.

During a thunderstorm, do not touch the projector or the cable.

Electric shocks can result.

Do not do anything that might damage the power cord or the power plug.

If the power cord is used while damaged, electric shocks, short-circuits or fire will result.

- Do not damage the power cord, make any modifications to it, place it near any hot objects, bend it excessively, twist it, pull it, place heavy objects on top of it or wrap it into a bundle.

Ask an Authorized Service Center to carry out any repairs to the power cord that might be necessary.

Do not use anything other than the provided power cord.

Failure to observe this will result in electric shocks or fire. Please note that if you do not use the provided power cord to ground the device on the side of the outlet, this may result in electric shocks.

Completely insert the power plug into the wall outlet and the power connector into the projector terminal.

If the plug is not inserted correctly, electric shocks or overheating will result.

- Do not use plugs which are damaged or wall outlets which are coming loose from the wall.

Do not handle the power plug and power connector with wet hands.

Failure to observe this will result in electric shocks.

Do not overload the wall outlet.

If the power supply is overloaded (ex., by using too many adapters), overheating may occur and fire will result.

Clean the power plug regularly to prevent it from becoming covered in dust.

Failure to observe this will cause a fire.

- If dust builds up on the power plug, the resulting humidity can damage the insulation.
- If not using the projector for an extended period of time, pull the power plug out from the wall outlet.

Pull the power plug out from the wall outlet and wipe it with a dry cloth regularly.

■ ON USE/INSTALLATION

Do not place the projector on soft materials such as carpets or sponge mats.

Doing so will cause the projector to overheat, which can cause burns, fire or damage to the projector.

Do not set up the projector in humid or dusty places or in places where the projector may come into contact with oily smoke or steam.

Using the projector under such conditions will result in fire, electric shocks or deterioration of components. Oil may also cause deterioration of plastics and the projector installed to the ceiling etc. could fall.

Do not install this projector in a place which is not strong enough to take the full weight of the projector or on top of a surface which is sloped or unstable.

Failure to observe this will cause projector to fall down or tip over the projector, and severe injury or damage could result.

Do not install the projector in a location where people pass through.

People may bump into the projector or trip on the power cord, which may result in fire, electric shock, or injury.

Do not cover the intake/exhaust vents.

Doing so will cause the projector to overheat, which can cause fire or damage to the projector.

- Do not place the projector in narrow, badly ventilated places.
- Do not place the projector on cloth or papers, as these materials could be drawn into the intake vent.
- Provide at least 1 m (39-3/8") of space between any walls or objects and the exhaust vent, and at least 50 cm (19-11/16") of space between any walls or objects and the intake vent.

WARNING:

Do not look at or place your skin into the light emitted from the lens while the projector is being used. Do not enter the projection luminous flux using an optical device (such as magnifier or mirror).

Doing so can cause burns or loss of sight.

- Strong light is emitted from the projector's lens. Do not look at or place your hands directly into this light.
- Be especially careful not to let young children look into the lens. In addition, turn off the power and disconnect the power plug when you are away from the projector.

Do not project an image with the lens cover attached.

Doing so can cause fire.

Never attempt to remodel or disassemble the projector.

High voltages can cause fire or electric shocks.

- For any inspection, adjustment and repair work, please contact an Authorized Service Center.

Do not allow metal objects, flammable objects, or liquids to enter inside of the projector. Do not allow the projector to get wet.

Doing so may cause short circuits or overheating, and result in fire, electric shock, or malfunction of the projector.

- Do not place containers of liquid or metal objects near the projector.
- If liquid enters inside of the projector, consult your dealer.
- Particular attention must be paid to children.

Use the ceiling mount bracket specified by Panasonic Connect Co., Ltd.

Using the ceiling mount bracket other than the specified one will result in falling accidents.

- Attach the supplied safety cable to the ceiling mount bracket to prevent the projector from falling down.

Installation work such as mounting the projector on the ceiling should only be carried out by a qualified technician.

If installation is not carried out and secured correctly, it can cause injury or accidents, such as electric shocks.

■ ACCESSORIES

Do not use or handle the batteries improperly, and refer to the following.

Failure to observe this will cause burns, batteries to leak, overheat, explode or catch fire.

- Do not use unspecified batteries.
- Do not charge dry cell batteries.
- Do not disassemble dry cell batteries.
- Do not heat the batteries or place them into water or fire.
- Do not allow the + and - terminals of the batteries to come into contact with metallic objects such as necklaces or hairpins.
- Do not store or carry batteries together with metallic objects.
- Store the batteries in a plastic bag and keep them away from metallic objects.
- Make sure the polarities (+ and -) are correct when inserting the batteries.
- Do not use a new battery together with an old battery or mix different types of batteries.
- Do not use batteries with the outer cover peeling away or removed.

If the battery fluid leaks, do not touch it with bare hands, and take the following measures if necessary.

- Battery fluid on your skin or clothing could result in skin inflammation or injury.
Rinse with clean water and seek medical advice immediately.
- Battery fluid coming in contact with your eyes could result in loss of sight.
In this case, do not rub your eyes. Rinse with clean water and seek medical advice immediately.

Do not allow children to reach the batteries.

Accidentally swallowing them can cause physical harm.

- If swallowed, seek medical advice immediately.

Remove the depleted batteries from the remote control promptly.

- Leaving them in the unit may result in fluid leakage, overheating, or explosion of the batteries.

CAUTION:

■ POWER

When disconnecting the power cord, be sure to hold the power plug and power connector.

If the power cord itself is pulled, the lead will become damaged, and fire, short-circuits or serious electric shocks will result.

When not using the projector for an extended period of time, disconnect the power plug from the wall outlet.

Failure to do so may result in fire or electric shock.

Disconnect the power plug from the wall outlet before carrying out any cleaning and replacing the unit.

Failure to do so may result in electric shock.

■ ON USE/INSTALLATION

Do not place heavy objects on top of the projector.

Failure to observe this will cause the projector to become unbalanced and fall, which could result in damage or injury. The projector will be damaged or deformed.

Do not put your weight on this projector.

You could fall or the projector could break, and injury will result.

- Be especially careful not to let young children stand or sit on the projector.

Do not place the projector in extremely hot locations.

Doing so will cause the outer casing or internal components to deteriorate, or result in fire.

- Take particular care in locations exposed to direct sunlight or near heaters.

Do not install the projector in a location where salt pollution or corrosive gas may occur.

Doing so may result in falling due to corrosion. Also, it may result in malfunctions.

Do not stand in front of the lens while the projector is being used.

Doing so can cause damage and burns to clothing.

- Strong light is emitted from the projector's lens.

Do not place objects in front of the lens while the projector is being used.

Do not block the projection by placing an object in front of the projection lens.

Doing so can cause fire, damage to an object, or malfunction of the projector.

- Strong light is emitted from the projector's lens.

Always disconnect all cables before moving the projector.

Moving the projector with cables still attached can damage the cables, which will cause fire or electric shocks to occur.

Never plug headphones and earphones into <VARIABLE AUDIO OUT> terminal.

Excessive sound pressure from headphones and earphones can cause hearing loss.

When mounting the projector on the ceiling, keep mounting screws and power cord from contact with metal parts inside the ceiling.

Contact with metal parts inside the ceiling can cause electric shocks.

■ ACCESSORIES

When not using the projector for an extended period of time, remove the batteries from the remote control.

Failure to observe this will cause the batteries to leak, overheat, catch fire or explode, which may result in fire or contamination of surrounding area.

■ MAINTENANCE

Do not attach the air filter unit while it is wet.

Doing so may result in electric shock or malfunctions.

- After you clean the air filter units, dry them thoroughly before reattaching them.

Ask your dealer about cleaning inside the projector every 20 000 hours of usage as an estimated duration.

Continuous use while dust is accumulated inside the projector may result in fire.

- For cleaning fee, ask your dealer.

To remove the battery

Remote Control Battery

1. Press the guide and lift the cover.

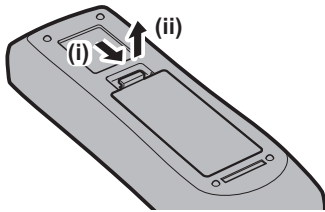

2. Remove the batteries.

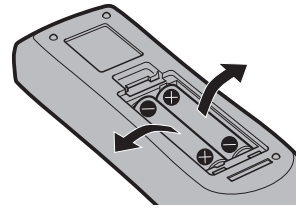

Brazil Only

Brasil Apenas

■ Manuseio de baterias usadas

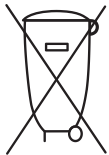

BRASIL

Após o uso, as pilhas e/ou baterias deverão ser entregues ao estabelecimento comercial ou rede de assistência técnica autorizada.

Cobrir os terminais positivo (+) e negativo (-) com uma fita isolante adesiva, antes de depositar numa caixa destinada para o recolhimento. O contato entre partes metálicas pode causar vazamentos, gerar calor, romper a blindagem e produzir fogo. (Fig. 1)

Fig. 1
Como isolar os terminais

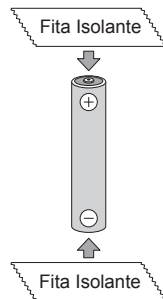

Não desmonte, não remova o invólucro, nem amasse a bateria. O gás liberado pela bateria pode irritar a garganta, danificar o lacre do invólucro ou o vazamento provocar calor, ruptura da blindagem e produzir fogo devido ao curto circuito dos terminais. Não incinere nem aqueça as baterias, elas não podem ficar expostas a temperaturas superiores a 100 °C (212 °F). O gás liberado pela bateria pode irritar a garganta, danificar o lacre do invólucro ou o vazamento provocar calor, ruptura da blindagem e produzir fogo devido ao curto circuito dos terminais provocado internamente.

Evite o contato com o líquido que vazar das baterias. Caso isto ocorra, lave bem a parte afetada com bastante água. Caso haja irritação, consulte um médico.

■ Remoção das baterias

1. Pressione a guia e levante a tampa.

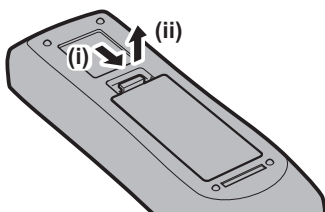

2. Remova as baterias.

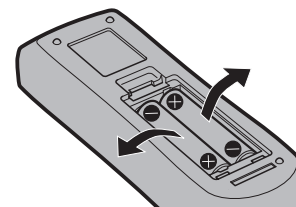

■ Trademarks

- SOLID SHINE is a trademark of Panasonic Holdings Corporation.
- The terms HDMI and HDMI High-Definition Multimedia Interface, and the HDMI Logo are trademarks or registered trademarks of HDMI Licensing Administrator, Inc. in the United States and other countries.
- PJLink™ is a registered trademark or pending trademark in Japan, the United States, and other countries and regions.
- Crestron Connected, the Crestron Connected logo, Crestron Fusion, Crestron RoomView, and RoomView are trademarks or registered trademarks of Crestron Electronics, Inc. in the United States and/or other countries.
- HDBaseT™ is a trademark of HDBaseT Alliance.
- Windows, Internet Explorer and Microsoft Edge are registered trademarks or trademarks of Microsoft Corporation in the United States and other countries.
- Mac, OS X, macOS, iPad, iPhone, iPod touch and Safari are trademarks of Apple Inc., registered in the United States and other countries.
- IOS is a trademark or registered trademark of Cisco in the U.S. and other countries and is used under license.
- Android and Google Chrome are trademarks of Google LLC.
- QR Code is a registered trademark of DENSO WAVE INCORPORATED in Japan and in other countries.
- Adobe, Acrobat and Reader are either registered trademarks or trademarks of Adobe Systems Incorporated in the United States and/or other countries.
- Some of the fonts used in the on-screen menu are Ricoh bitmap fonts, which are manufactured and sold by Ricoh Company, Ltd.
- All other names, company names, and product names mentioned in this manual are trademarks or registered trademarks of their respective owners.
Please note that the ® and ™ symbols are not specified in this manual.

■ Software information regarding this product

This product incorporates the following software:

- (1) the software developed independently by or for Panasonic Connect Co., Ltd.,
- (2) the software owned by third party and licensed to Panasonic Connect Co., Ltd.,
- (3) the software licensed under the GNU General Public License, Version 2.0 (GPL V2.0),
- (4) the software licensed under the GNU LESSER General Public License, Version 2.1 (LGPL V2.1), and/or
- (5) open source software other than the software licensed under the GPL V2.0 and/or LGPL V2.1.

The software categorized as (3) - (5) are distributed in the hope that it will be useful, but WITHOUT ANY WARRANTY, without even the implied warranty of MERCHANTABILITY or FITNESS FOR A PARTICULAR PURPOSE. Please refer to the license terms and conditions of each open source software. The open source software license is stored in the firmware of this product and can be downloaded by accessing the projector using a web browser. For details, please refer to “Web control function” (➡ page 126).

At least three (3) years from delivery of this product, Panasonic Connect Co., Ltd. will give to any third party who contacts us at the contact information provided below, for a charge no more than our cost of physically performing source code distribution, a complete machine-readable copy of the corresponding source code covered under GPL V2.0, LGPL V2.1 or the other licenses with the obligation to do so, as well as the respective copyright notice thereof.

Contact Information: oss-cd-request@gg.jp.panasonic.com

Presenter Light uses the following software programs.

A portion of this software is based in part on the work of the Independent JPEG Group.

■ Illustrations in these operating instructions

- Illustrations of the projector, menu screen (OSD), and other parts may vary from the actual product.
- Illustrations displayed on the computer screen may differ depending on the computer type and its operating system.
- Illustrations of the projector with the power cord attached are only examples. The shape of the supplied power cords varies depending on the country where you purchased the product.
- Pictures shown are illustrations of PT-VMZ71 in this manual, other models have their own characteristics and may be different from them.

■ Page references

- Reference pages in this manual are indicated as : (➡ page 00).

■ Term

- In this manual, the “Wireless remote control unit” accessory is referred to as the “Remote control”.

Features of the Projector

Compact design and light weight

- ▶ In addition to a brightness of 7 000 lm^{*1} that makes it easy to view images even in bright spaces, a compact and lightweight design of only 7.0 kg^{*2} makes it easy to carry, adjust and fit well even in small spaces.

*1 PT-VMZ71: 7 000 lm
PT-VMZ61, PT-VMW61: 6 200 lm
PT-VMZ51, PT-VMZ51S, PT-VMW51: 5 200 lm
PT-VMZ41: 4 500 lm

*2 PT-VMZ71: 7.0 kg
PT-VMZ61, PT-VMW61: 6.9 kg
PT-VMZ51, PT-VMZ51S, PT-VMW51, PT-VMZ41: 6.5 kg

High reliability

- ▶ The SOLID SHINE laser light source allows long-term operation of 20 000 hours^{*1}.

*1 This is an estimated usage time until the brightness is approximately halved, under conditions with a dust level of 0.15 mg/m³, [PROJECTOR SETUP] menu → [ECO MANAGEMENT] → [LIGHT POWER] set to [NORMAL] and [PICTURE] menu → [DYNAMIC CONTRAST] set to [2].

Flexible setup

- ▶ In addition to the 1.6x zoom lens and the horizontal/vertical lens shift, the new Digital Zoom Extender and 6-Point Correction functions are adopted, making it possible for installation in a limited space, projection from a longer distance or projection onto a corner.

Excellent extensibility

- ▶ 4K signal^{*1} input is supported to embrace a future system update.
- ▶ Easy wireless projection is possible by using the optional wireless module. The QR Code displayed makes wireless LAN connection setting easier.
- ▶ The CEC-compatible HDMI terminals support interlocked operation between the projector and the external device.

*1 Supports signals up to 4K/30p. A signal with different resolution is converted to the number of display dots.
PT-VMZ71, PT-VMZ61, PT-VMZ51, PT-VMZ51S, PT-VMZ41:
1 920 x 1 200 dots
PT-VMW61, PT-VMW51: 1 280 x 800 dots

Quick Steps

For details, refer to the corresponding pages.

1. **Set up your projector.**
(⇒ page 35)



2. **Connect with external devices.**
(⇒ page 40)



3. **Connect the power cord.**
(⇒ page 45)



4. **Power on.**
(⇒ page 47)



5. **Make initial settings.**
(⇒ page 47)

- Take this step when you power on for the first time after purchasing the projector.



6. **Select the input signal.**
(⇒ page 53)



7. **Adjust the image.**
(⇒ page 55)

Chapter 1 Preparation

This chapter describes things you need to know or check before using the projector.

Precautions for use

Intended use of the product

The product is intended to project still/moving image signals from video equipment and computers onto a screen.

Cautions when transporting

- When transporting the projector, hold it securely by its bottom and avoid excessive vibration and impacts. Doing so may damage the internal parts and result in malfunctions.
- Do not transport the projector with the adjustable feet extended. Doing so may damage the adjustable feet.
- Do not move or transport the projector with the wireless module (Model No.: AJ-WM50) of the optional accessories attached. Doing so may damage the wireless module.

Cautions when installing

■ Do not set up the projector outdoors.

The projector is designed for indoor use only.

■ Do not use under the following conditions.

- Places where vibration and impacts occur such as in a car or vehicle: Doing so may damage the internal parts and result in malfunctions.
- Location close to sea or where corrosive gas may occur: the projector may fall due to corrosion. Also, failure to do so may shorten the life of the components and result in malfunction.
- Near the exhaust of an air conditioner: Depending on the conditions of use, the screen may fluctuate in rare cases due to the heated air from the exhaust vent or the hot or cooled air. Make sure that the exhaust from the projector or other equipment, or the air from the air conditioner does not blow toward the front of the projector.
- Places with sharp temperature fluctuations such as near lights (studio lamps): Doing so may shorten the life of the light source, or result in deformation of the outer case due to heat, which may cause malfunction. Make sure to observe the operating temperature range of the projector.
- Near high-voltage power lines or near motors: Doing so may interfere with the operation of the projector.

■ Ask a qualified technician or your dealer for the installation work such as installing to a ceiling.

To ensure projector performance and safety, ask a qualified technician or your dealer when installing to a ceiling or in a high place.

■ Ask a qualified technician or your dealer to install the cable wiring for DIGITAL LINK connection.

(Not available for PT-VMZ51S and PT-VMZ41)

Image and sound may be disrupted if cable transmission characteristics cannot be obtained due to inadequate installation.

■ The projector may not work properly due to strong radio wave from the broadcast station or the radio.

(Not available for PT-VMZ51S and PT-VMZ41)

If there is any facility or equipment which outputs strong radio waves near the installation location, install the projector at a location sufficiently far from the source of the radio waves. Or, wrap the LAN cable connected to the <DIGITAL LINK/LAN> terminal using a piece of metal foil or a metal pipe which is grounded at both ends.

■ Focus adjustment

The projection lens is thermally affected by the light from the light source, making the focus unstable in the period just after switching on the power. It is recommended that the images are projected continuously for at least 30 minutes before the focus is adjusted.

- Do not install the projector at elevations of 2 700 m (8 858') or higher above sea level.
- Do not use the projector in a location that the ambient temperature exceeds 45 °C (113 °F).

Using the projector in a location that the altitude is too high or the ambient temperature is too high may shorten the life of the components or result in malfunctions.

When the optional wireless module (Model No.: AJ-WM50) is attached, do not use the projector in a location that the ambient temperature exceeds 40 °C (104 °F).

- Projection in all 360° direction is possible.

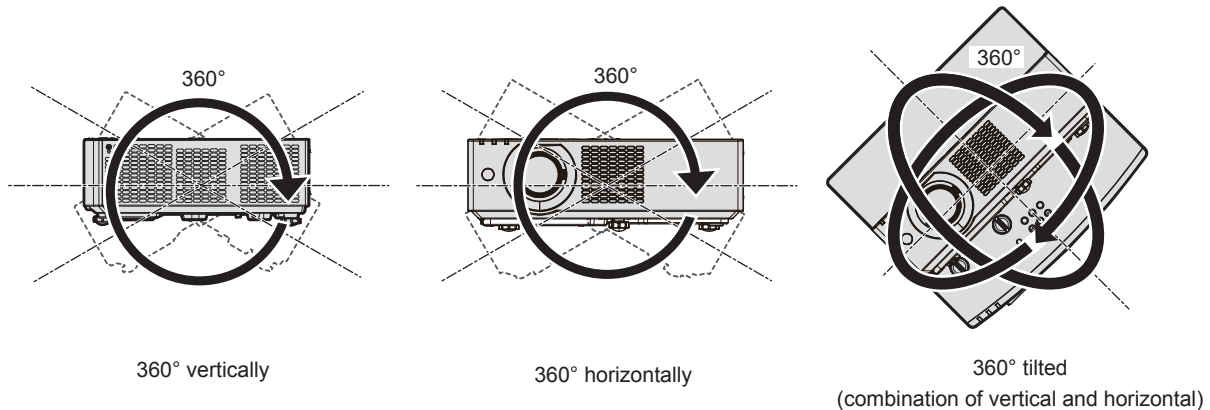

Cautions when setting the projectors

- Use the adjustable feet only for the floor standing installation and for adjusting the angle. Using them for other purposes may damage the projector.
- When installing the projector with a method other than the floor installation using the adjustable feet or the ceiling installation using the ceiling mount bracket, use the four screw holes for ceiling mount (as shown in the figure) to fix the projector. In such case, make sure that there is no clearance between the screw holes for ceiling mount on the projector bottom and the setting surface by inserting spacers (metallic) between them.
- Use a torque screwdriver or Allen torque wrench to tighten the fixing screws to their specified tightening torques. Do not use electric screwdrivers or impact screwdrivers. (Screw diameter: M4, tapping depth inside the projector: 8 mm (5/16"), torque: 1.25 ± 0.2 N·m)

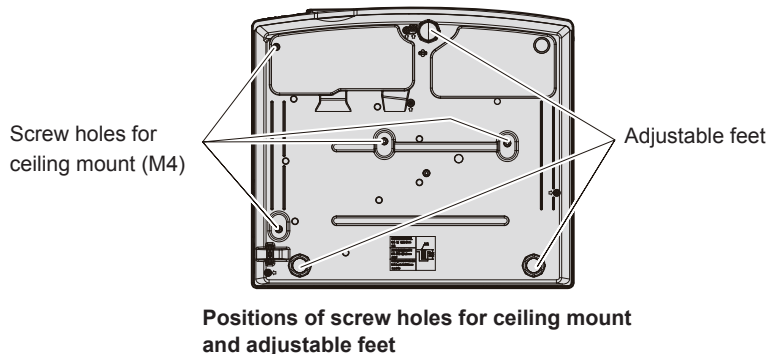

- Do not stack the projectors.
- Do not use the projector supported by its top.
- Do not block the intake and exhaust vents of the projector.
- Avoid heating and cooling air from the air conditioning system directly blow to the intake and exhaust vents of the projector.

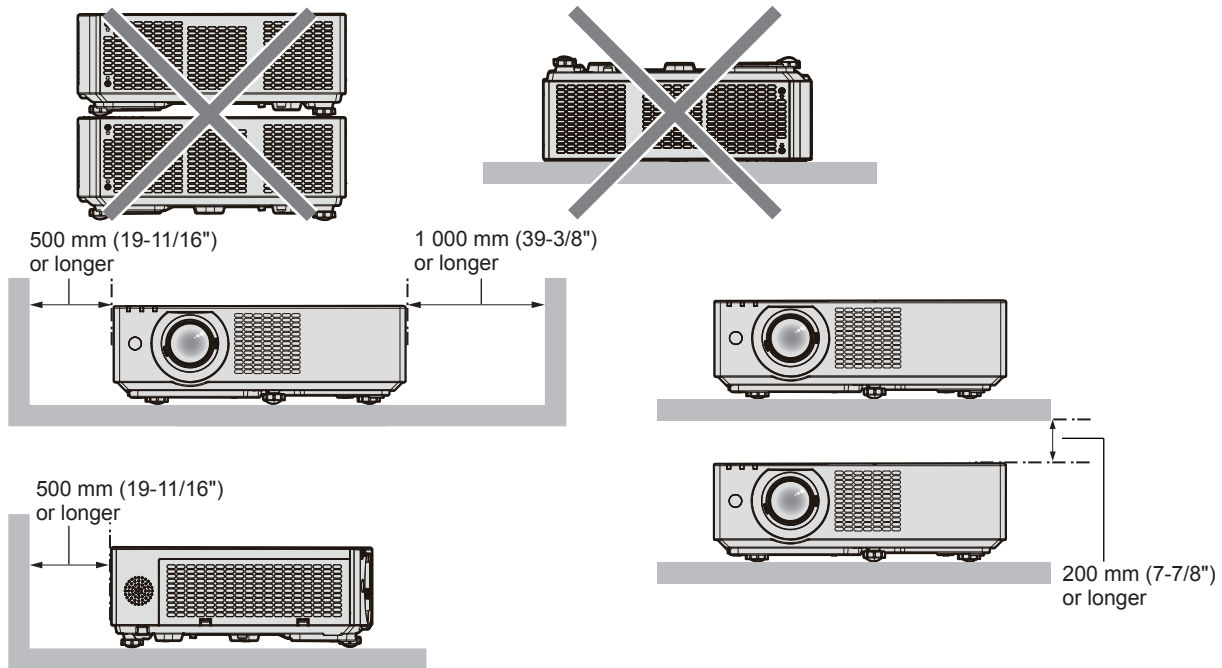

- Do not install the projector in a confined space.
When placing the projector in a confined space, a ventilation and/or air conditioning system is required. Exhaust heat may accumulate when the ventilation is not enough, triggering the protection circuit of the projector.
- Panasonic Connect Co., Ltd. takes no responsibility for any damage to the product caused by an inappropriate choice of location for installing the projector, even if the warranty period of the product has not expired.

Security

When using this product, take safety measures against the following incidents.

- Personal information being leaked via this product
- Unauthorized operation of this product by a malicious third party
- Interfering or stopping of this product by a malicious third party

Take sufficient security measures.

- Make your password as difficult to guess as possible.
- Change your password periodically.
- Panasonic Connect Co., Ltd. or its affiliate company never inquires a password directly to a customer. Do not tell your password in case you receive such an inquiry.
- The connecting network must be secured by firewall or others.

■ Security when using the wireless LAN product

The advantage of a wireless LAN is that information can be exchanged between a computer or other such equipment and a wireless access point using radio waves, instead of using a LAN cable, as long as you are within range for radio transmissions.

On the other hand, because the radio wave can travel through an obstacle (such as a wall) and is accessible from anywhere within a given range, following problems may occur if security setting is insufficient.

- Transmitted data may be intercepted

A malicious third party may intentionally intercept radio waves and monitor the following transmitted data.

- Personal information such as your ID, password, credit card number
- Content of an Email

- Illegally accessed

A malicious third party may access your personal or corporate network without authorization and engage in the following types of behavior.

- Retrieve personal and/or secret information (information leak)
- Spread false information by impersonating a particular person (spoofing)
- Overwrite intercepted communications and issue false data (tampering)
- Spread harmful software such as a computer virus and crash your data and/or system (system crash)

Since most wireless LAN adapters or access points are equipped with security features to take care of these problems, you can reduce the possibility of these problems occurring when using this product by making the

appropriate security settings for the wireless LAN device.

Some wireless LAN devices may not be set for security immediately after purchase. To decrease the possibility of occurrence of security problems, be sure to make all security related settings according to the operation instructions supplied with each wireless LAN device before using a wireless LAN device.

Depending on the specifications of the wireless LAN, a malicious third party may be able to break security settings by special means.

Panasonic Connect Co., Ltd. asks customers to thoroughly understand the risk of using this product without making security settings, and recommends that the customers make security settings at their own discretion and responsibility.

Notes regarding the wireless LAN

Wireless connection function of the projector uses radio waves in the 2.4 GHz band.

A radio station license is not required, but be sure to read and fully understand the following items before use.

The wireless module (Model No.: AJ-WM50) of optional accessories must be installed when you want to use the wireless LAN function of the projector.

■ Do not use near other wireless equipment.

The following equipment may use radio waves in the same band as the projector.

When the projector is used near these devices, radio wave interference may make communication impossible, or the communication speed may become slower.

- Microwave ovens, etc.
- Industrial, chemical and medical equipment, etc.
- In-plant radio stations for identifying moving objects such as those used in factory manufacturing lines, etc.
- Designated low-power radio stations

■ Do not use cell phone, television, or radio as much as possible close to the projector.

Cell phone, television, or radio is using radio wave with different bandwidth from the projector, so there is no effect on the wireless LAN communication or the send/receive on these devices. However, noise may occur in the audio or video due to the radio wave from the projector.

■ Wireless communication radio waves cannot penetrate steel reinforcements, metal, concrete, etc.

Communication is possible through walls and floors made from materials such as wood and glass (except glass containing wire mesh), but not through walls and floors made from steel reinforcements, metal, concrete, etc.

■ Avoid using the projector in locations prone to static electricity.

If the projector is used in a location prone to static electricity, the wireless LAN or wired LAN connection may be lost.

If the static electricity or noise make it impossible to establish a connection with the LAN, disconnect the power plug from the outlet after turning off the projector power, eliminate the source of static electricity or noise, then turn on the projector.

DIGITAL LINK

(Not available for PT-VMZ51S and PT-VMZ41)

“DIGITAL LINK” is a technology that uses a twisted-pair-cable to transmit video, audio, Ethernet, and serial control signals. It is developed based on the communication standard of HDBaseT™ established by HDBaseT Alliance and added with other features of Panasonic Connect Co., Ltd.

This projector supports the optional DIGITAL LINK output compatible device (Model No.: ET-YFB100G, ET-YFB200G) and peripheral devices by other manufacturers (twisted-pair-cable transmitters such as the “XTP transmitter” of Extron Electronics) that use the same HDBaseT™ standard. For the devices of other manufacturers that the operation has been verified with this projector, visit the website (<https://panasonic.net/cns/projector/>). Note that the verification for devices of other manufacturers has been made for the items set by Panasonic Connect Co., Ltd., and not all the operations have been verified. For operation or performance problems caused by the devices of other manufacturers, contact the respective manufacturers.

Application software supported by the projector

The projector supports following application software. For details or downloading each application software, visit the website (<https://panasonic.net/cns/projector/>).

• Logo Transfer Software

This application software transfers the original image, such as company logo, which is projected at the start, to the projector.

• Multi Monitoring & Control Software

This application software monitors and controls the multiple display devices (projector and flat panel display) connected to an intranet.

• Early Warning Software

This plug-in software monitors the status of the display devices and their peripherals within an intranet, and notifies of abnormality of such equipment and detects the signs of possible abnormality. "Early Warning Software" is preinstalled in the "Multi Monitoring & Control Software". To use the early warning function of this plug-in software, install "Multi Monitoring & Control Software" in the PC to be used. By enabling the early warning function, it will notify of the approximate time to replace the consumables for the display devices, to clean each part of the display devices, and to replace the components of the display devices, allowing to execute maintenance in advance.

The early warning function can be used by registering maximum of 2048 display devices free of charge for 90 days after installing the "Multi Monitoring & Control Software" into a PC. To continuously use after the 90 days, it is necessary to purchase the license of "Early Warning Software" (ET-SWA100 Series) and perform the activation. Also, depending on the type of license, the number of display devices that can be registered for monitoring varies. For details, refer to the Operating Instructions of "Multi Monitoring & Control Software".

• Presenter Light Software

This application software compatible with Windows computers transmits the computer screen to the projector via wireless LAN or wired LAN.

• Wireless Projector

This application software for iOS/Android is used to project files such as PDF or image by transmitting to the projector via wireless LAN.

Storage

When storing the projector, keep it in a dry room.

Disposal

To dispose of the product, ask your local authorities or dealer for correct methods of disposal. Also, dispose of the product without disassembling.

Cautions on use

■ To get a good picture quality

In order to view a beautiful image in higher contrast, prepare an appropriate environment. Draw curtains or blinds over windows and turn off any lights near the screen to prevent outside light or light from indoor lamps from shining onto the screen.

■ Projection Lens

- Do not touch the surface of the projector lens with your bare hands.

If the surface of the lens becomes dirty from fingerprints or anything else, this will be magnified and projected onto the screen.

It is recommended to attach the supplied lens cap to the projection lens when you do not use the projector.

- Do not wipe the lens during operation.

Cleaning the lens during operation may cause foreign objects adhering to the lens or bring damage to the lens surface.

■ LCD panel

The LCD panel is precision-made. Note that in rare cases, pixels could be missing or always lit. Note that such phenomena do not indicate malfunction.

If still images are projected for a long time, a residual image may remain on the LCD panel. In this case, project



Indicated on the projector

the all white screen for over an hour. Note that the residual image may not disappear.

■ Optical parts

When the operating environment temperature is high or in environments where lots of dust, cigarette smoke, etc. is present, the replacement cycle of the LCD panel, polarizing plate and other optical parts may be shorter even if used for less than one year. Consult your dealer for details.

■ Do not move the projector or subject it to vibration or impact while it is operating.

Doing so may shorten the life of internal components or result in malfunctions.

■ Light source

The light source of the projector uses laser diode, and has the following characteristics.

- Depending on the operating environment temperature, the luminance of the light source will decrease.
The higher the temperature becomes, the more the luminance of the light source decreases.
- The luminance of the light source will decrease by duration of usage.
If brightness is noticeably reduced and the light source does not turn on, ask your dealer to clean inside the projector or replace the light source unit.

■ Computer and external device connections

When connecting a computer or an external device, read this manual carefully regarding the use of power cords and shielded cables as well.

Accessories

Make sure the following accessories are provided with your projector. Numbers enclosed < > show the number of accessories.

Wireless remote control unit <1>

For PT-VMZ71,
PT-VMZ61, PT-VMZ51,
PT-VMW61, PT-VMW51
(N2QAYA000234)



For PT-VMZ51S,
PT-VMZ41
(N2QAYA000237)

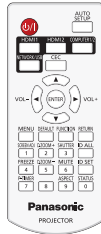

For India
(K2CZ3YY00092)

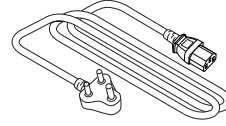

For Taiwan
(K2CG3YY00145)

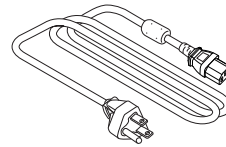

Power cord

(K2CM3YY00027)

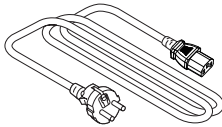

AAA/R03 or AAA/LR03 battery <2>

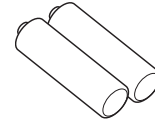

(for remote control unit)

(K2CT3YY00052)

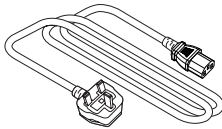

Lens cap <1>

(TKKL5573-1)



(Attached to the projector at the time of purchase)

(K2CG3YY00106)

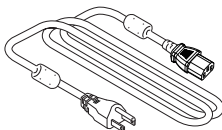

String <1>

(1AA2SRZ0013A-)



(for lens cap)

Attention

- After unpacking the projector, discard the power cord cap and packaging material properly.
- Do not use the supplied power cord for devices other than this projector.
- For lost accessories, consult your dealer.
- Store small parts in an appropriate manner, and keep them away from young children.

Note

- The type and number of the supplied power cords vary depending on the country or region where you purchased the product.
- The part numbers of accessories are subject to change without prior notice.

Optional accessories

Options	Model No.
Ceiling Mount Bracket	ET-PKL100H (for high ceilings), ET-PKL100S (for low ceilings), ET-PKV400B (Projector Mount Bracket)
Replacement Filter Unit	ET-RFV500
Digital Interface Box ^{*1}	ET-YFB100G
DIGITAL LINK Switcher ^{*1}	ET-YFB200G
Early Warning Software (Basic license/3-year license)	ET-SWA100 Series ^{*2}
Wireless Module ^{*3*4}	AJ-WM50 Series ^{*5}

*1 Not available for PT-VMZ51S and PT-VMZ41.

*2 The suffix of the Model No. differs according to the license type.

*3 In this document, the suffixes at the end of the model numbers are omitted.

*4 The availability of this product varies depending on the country. For details, contact your dealer.

*5 The suffix of the Model No. differs depending on the country.

Example of the Model No. with suffix for AJ-WM50 Series

AJ-WM50E, AJ-WM50G1, AJ-WM50G2, AJ-WM50GAN, AJ-WM50GPX, AJ-WM50P

Note

- Use the Wireless Module (Model No.: AJ-WM50) in an environment of 0 °C (32 °F) to 40 °C (104 °F), including when it is attached to the projector.
- The model numbers of optional accessories are subject to change without prior notice.
- The optional accessories compatible with the projector may be added or changed without prior notice. For the latest information, visit the website (<https://panasonic.net/cns/projector/>).

About your projector

Remote control

■ For PT-VMZ71, PT-VMZ61, PT-VMZ51, PT-VMW61, PT-VMW51

■ Front

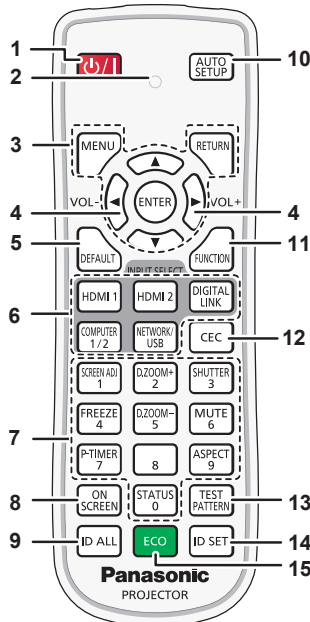

■ Top

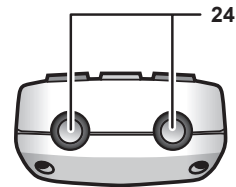

■ Bottom

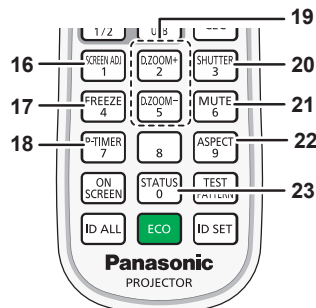
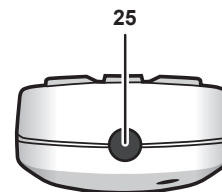

1 **Power** <⏻/▶> button

(⏻: Standby, ▶: Power on)

Sets the projector to the state where the projector is switched off (standby mode). Also starts projection when the power is switched off (standby mode).

2 **Remote control indicator**

Blinks if any button in the remote control is pressed.

3 **<MENU> button/<RETURN> button / <ENTER> button/ ▲▼◀▶ buttons**

Used to navigate through the menu screen. (➡ page 65)

▲▼◀▶ buttons are also used to enter the password in [SECURITY] or enter characters.

4 **<VOL-→> button/<VOL+→> button**

Adjusts the volume of the built-in speaker or audio output. (➡ page 57)

5 **<DEFAULT> button**

Resets the content of the sub-menu to the factory default. (➡ page 66)

6 **Input selection buttons (<HDMI1>, <HDMI2>, <DIGITAL LINK>, <COMPUTER1/2>, <NETWORK/USB>)**

Switches the input signal to project. (➡ page 53)

7 **Number (<0> ~ <9>) buttons**

Used for entering a password or an ID number in a multiple projector environment.

8 **<ON SCREEN> button**

Switches on (display)/off (hide) the on-screen display function. (➡ page 58)

9 **<ID ALL> button**

Used to simultaneously control all the projectors with a single remote control in a multi-projector environment. (➡ page 63)

10 **<AUTO SETUP> button**

Automatically adjusts the image display position while the image is projected. (➡ page 58)

11 **<FUNCTION> button**

Assigns a frequently used operation as a shortcut button. (➡ page 61)

12 **<CEC> button**

Displays the HDMI-CEC operation screen. (➡ page 97)

13 **<TEST PATTERN> button**

Displays the test pattern. (➡ page 62)

14 **<ID SET> button**

Sets the ID number of the remote control in a multi-projector environment. (➡ page 63)

15 **<ECO> button**

Displays the setting screen relating to ECO management. (➡ page 62)

16 **<SCREEN ADJ> button**

You can extend the projection distance via the Digital Zoom Extender function or correct various types of distortion in a projected image. (➡ page 59)

17 **<FREEZE> button**

Used when pausing the image and turning off the audio. (➡ page 58)

18 **<P-TIMER> button**

Operates the presentation timer function. (➡ page 61)

19 **<D.ZOOM +> button / <D.ZOOM -> button**

Zoom in and out the images. (➡ page 59)

20 **<SHUTTER> button**

Used to turn off the audio and video temporarily. (➡ page 57)

21 **<MUTE> button**

Used to temporarily mute the projector. (➡ page 57)

22 **<ASPECT> button**

Switches the aspect ratio of the image. (➡ page 61)

23 **<STATUS> button**

Displays the projector information. (➡ page 62)

24 **Remote control signal transmitter**

25 **Not available with this projector**

Attention

- Do not drop the remote control.
 - Avoid contact with liquids or moisture.
 - Do not attempt to modify or disassemble the remote control.
 - Please observe the following contents that are described on the back of the remote control unit (see the picture below).
 - Do not use a new battery together with an old battery.
 - Do not use unspecified batteries.
 - Make sure the polarities (+ and -) are correct when inserting the batteries.
- In addition, please read the contents that are related to batteries in the "Read this first!".

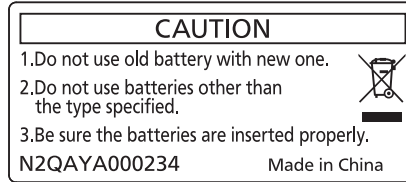

Caution label at the back of the remote control

Note

- The remote control can be used within a distance of about 30 m (98'5") if pointed directly at the remote control signal receiver. The remote control can control at angles of up to $\pm 30^\circ$ vertically and $\pm 30^\circ$ horizontally, but the effective control range may be reduced.
- If there are any obstacles between the remote control and the remote control signal receiver, the remote control may not operate correctly.
- You can operate the projector by reflecting the remote control signal on the screen. The operating range may differ due to the loss of light caused by the properties of the screen.
- When the remote control signal receiver is lit with a fluorescent light or other strong light source, the projector may become inoperative. Set the projector as far from the luminous source as possible.
- The power indicator <ON (G)/STANDBY (R)> will blink if the projector receives a remote control signal.

■ For PT-VMZ51S and PT-VMZ41

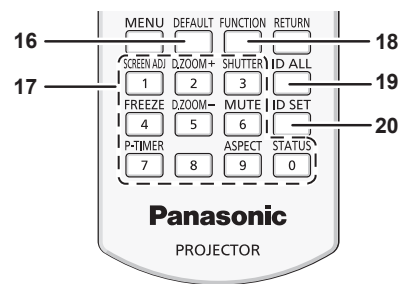
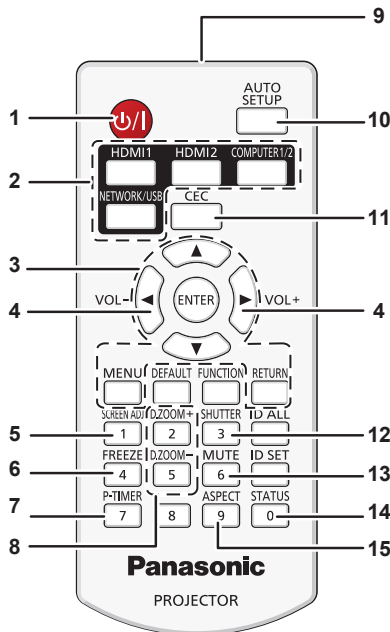

- 1 Power <⏻/⏻> button**
(⏻: Standby, ⏻: Power on)
Sets the projector to the state where the projector is switched off (standby mode). Also starts projection when the power is switched off (standby mode).
- 2 Input selection buttons (<HDMI1>, <HDMI2>, <COMPUTER1/2>, <NETWORK/USB>)**
Switches the input signal to project. (➡ page 53)
- 3 <MENU> button/<RETURN> button / <ENTER> button/ ▲▼◀▶ buttons**
Used to navigate through the menu screen. (➡ page 65)
▲▼◀▶ buttons are also used to enter the password in [SECURITY] or enter characters.
- 4 <VOL-> button/<VOL+> button**
Adjusts the volume of the built-in speaker or audio output. (➡ page 57)

- 5 <SCREEN ADJ> button**
You can extend the projection distance via the Digital Zoom Extender function or correct various types of distortion in a projected image. (➡ page 59)
- 6 <FREEZE> button**
Used when pausing the image and turning off the audio. (➡ page 58)
- 7 <P-TIMER> button**
Operates the presentation timer function. (➡ page 61)
- 8 <D.ZOOM +> button / <D.ZOOM -> button**
Zoom in and out the images. (➡ page 59)
- 9 Remote control signal transmitter**
- 10 <AUTO SETUP> button**
Automatically adjusts the image display position while the image is projected. (➡ page 58)

- | | |
|---|--|
| <p>11 <CEC> button
Displays the HDMI-CEC operation screen. (➡ page 97)</p> <p>12 <SHUTTER> button
Used to turn off the audio and video temporarily. (➡ page 57)</p> <p>13 <MUTE> button
Used to temporarily mute the projector. (➡ page 57)</p> <p>14 <STATUS> button
Displays the projector information. (➡ page 62)</p> <p>15 <ASPECT> button
Switches the aspect ratio of the image. (➡ page 61)</p> <p>16 <DEFAULT> button
Resets the content of the sub-menu to the factory default. (➡ page 66)</p> | <p>17 Number (<0> ~ <9>) buttons
Used for entering a password or an ID number in a multiple projector environment.</p> <p>18 <FUNCTION> button
Assigns a frequently used operation as a shortcut button. (➡ page 61)</p> <p>19 <ID ALL> button
Used to simultaneously control all the projectors with a single remote control in a multi-projector environment. (➡ page 63)</p> <p>20 <ID SET> button
Sets the ID number of the remote control in a multi-projector environment. (➡ page 63)</p> |
|---|--|

Attention

- Do not drop the remote control.
 - Avoid contact with liquids or moisture.
 - Do not attempt to modify or disassemble the remote control.
 - Please observe the following contents that are described on the back of the remote control unit (see the picture below).
 - Do not use a new battery together with an old battery.
 - Do not use unspecified batteries.
 - Make sure the polarities (+ and -) are correct when inserting the batteries.
- In addition, please read the contents that are related to batteries in the "Read this first!".

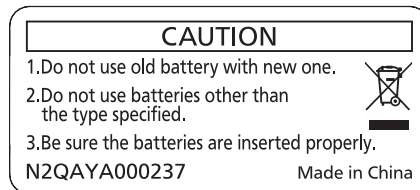

Caution label at the back of the remote control

Note

- The remote control can be used within a distance of about 20 m (65'7") if pointed directly at the remote control signal receiver. The remote control can control at angles of up to $\pm 30^\circ$ vertically and $\pm 30^\circ$ horizontally, but the effective control range may be reduced.
- If there are any obstacles between the remote control and the remote control signal receiver, the remote control may not operate correctly.
- You can operate the projector by reflecting the remote control signal on the screen. The operating range may differ due to the loss of light caused by the properties of the screen.
- When the remote control signal receiver is lit with a fluorescent light or other strong light source, the projector may become inoperative. Set the projector as far from the luminous source as possible.
- The power indicator <ON (G)/STANDBY (R)> will blink if the projector receives a remote control signal.

Projector body

■ Front

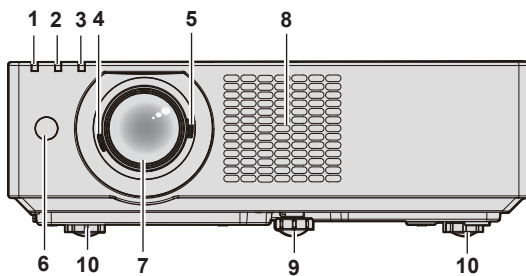

■ Side

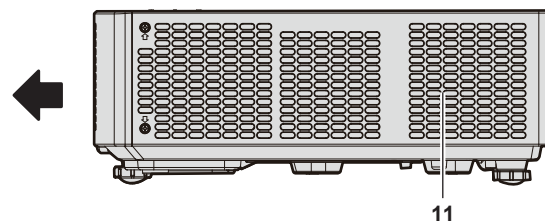

■ Rear

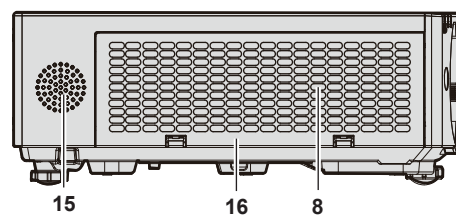
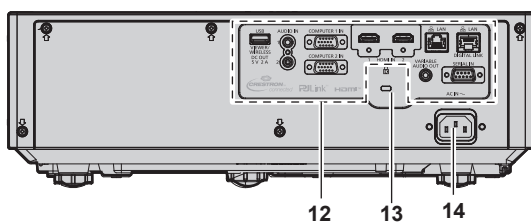

■ Top

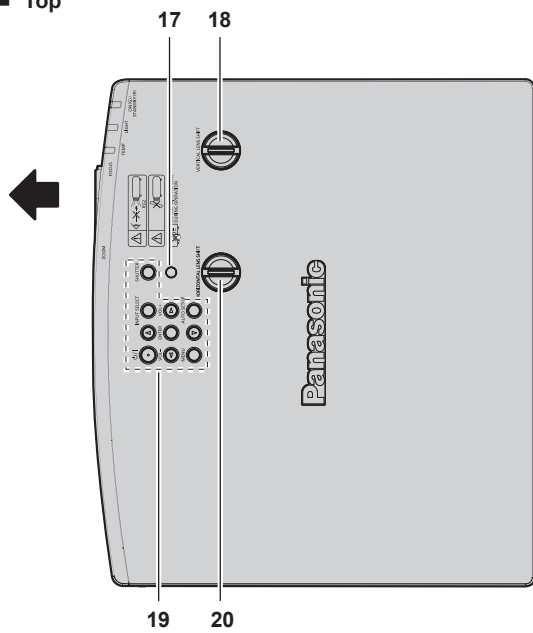

■ Bottom

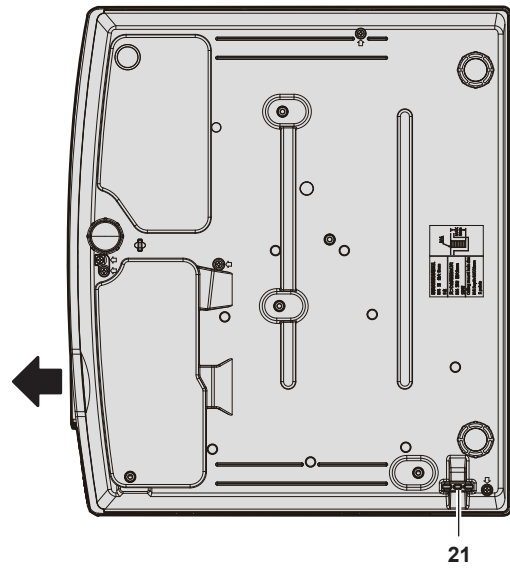

← : Projection direction

- | | |
|--|---|
| <ul style="list-style-type: none"> 1 Power indicator <ON (G)/STANDBY (R)>
Indicates the status of the power. 2 Light source indicator <LIGHT>
Indicates the status of the light source. 3 Temperature indicator <TEMP>
Indicates the internal temperature status. 4 Focus Lever
Adjusts the focus. 5 Zoom Lever
Adjusts the zoom. 6 Remote control signal receiver 7 Projection Lens 8 Intake vent 9 Front adjustable foot
Adjusts the projection angle. 10 Rear adjustable feet
Adjusts the projection angle. 11 Exhaust vent 12 Connecting terminals (⇒ page 31) | <ul style="list-style-type: none"> 13 Security slot
This security slot is compatible with the Kensington security cables. 14 <AC IN> terminal
Connects the supplied power cord. 15 Speaker 16 Air filter cover
The air filter unit is inside. 17 Ambient luminance sensor 18 Vertical lens shift dial
Adjusts the projecting position in the vertical direction (vertical shift). 19 Control panel (⇒ page 30) 20 Horizontal lens shift dial
Adjusts the projecting position in the horizontal direction (horizontal shift). 21 Burglar hook port
Attaches a burglar prevention cable, etc. |
|--|---|

Attention

- Do not block the intake and exhaust vents of the projector.
The components may deteriorate faster if cooling inside the projector is inhibited.

■ **Control panel**

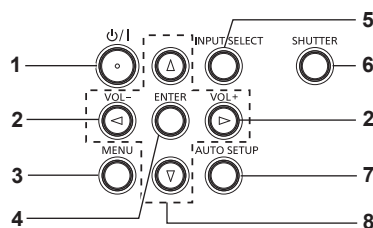

- | | |
|---|--|
| <ul style="list-style-type: none"> 1 Power <phi/I> button
(phi: Standby, I: Power on)
Sets the projector to the state where the projector is switched off (standby mode). Also starts projection when the power is switched off (standby mode). 2 <VOL-> button / <VOL+> button
Adjusts the volume of the built-in speaker or audio output.
(⇒ page 57) | <ul style="list-style-type: none"> 3 <MENU> button
Displays or hides the main menu. (⇒ page 65)
When the sub menu is displayed, pressing it will return to the previous screen. 4 <ENTER> button
Determines and executes an item in the menu screen. 5 <INPUT SELECT> button
Switches the input signal to project. (⇒ page 53) |
|---|--|

6 <SHUTTER> button

Used to turn off the audio and video temporarily. (➔ page 57)

7 <AUTO SETUP> button

Used to automatically adjust with auto setup function while projecting the image (➔ page 58). It is also used to operate the Memory Viewer screen.

8 ▲▼◀▶ buttons

Used to select the menu screen items, switch the setting or adjust the level.

Also used to enter a password in the [SECURITY] menu or enter characters.

■ Connecting terminals

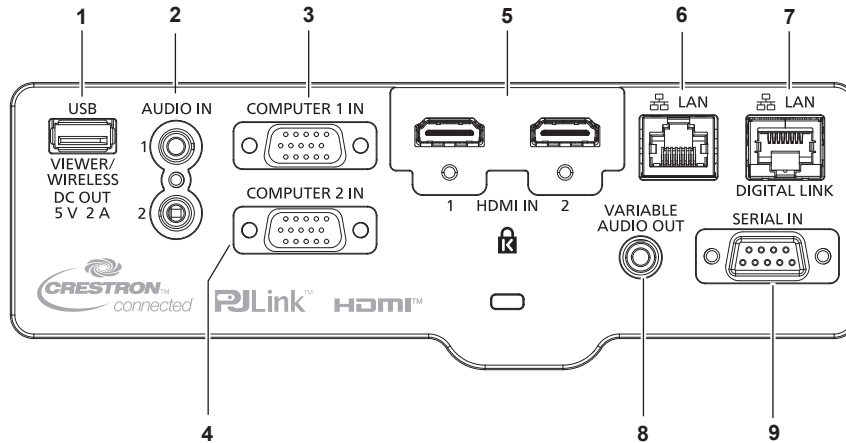

1 <USB (VIEWER/WIRELESS/DC OUT)> terminal

When using the Memory Viewer function, attach the USB memory directly to this terminal. (➔ page 116)
Attach the wireless module (Model No.: AJ-WM50) directly to this terminal when using the wireless LAN function. (➔ page 121)
In addition, this terminal can be used for power supply (DC 5 V, maximum 2 A).

2 <AUDIO IN 1> terminal / <AUDIO IN 2> terminal

These are the terminals to input audio signals.

3 <COMPUTER 1 IN> terminal

This is the terminal to input RGB signals or YC_BC_R/YP_BP_R signals.

4 <COMPUTER 2 IN> terminal

This is the terminal to input RGB signals or YC_BC_R/YP_BP_R signals.

5 <HDMI IN 1> terminal / <HDMI IN 2> terminal

These are the terminals to input HDMI signal.

6 <LAN> terminal

This is the LAN terminal to connect to the network.
This also supports the image transfer from the image transfer application software. (➔ page 119)

7 <DIGITAL LINK/LAN> terminal

(Not available for PT-VMZ51S and PT-VMZ41)
This is a terminal to connect a device that transfer image signal or audio signal. Also, this is the LAN terminal to connect to the network.

8 <VARIABLE AUDIO OUT> terminal

This is the terminal to output the input audio signal.

9 <SERIAL IN> terminal

This is the RS-232C compatible terminal to externally control the projector by connecting a computer.

Attention

- When the [PROJECTOR SETUP] menu → [ECO MANAGEMENT] → [STANDBY MODE] is set to [NORMAL], the <USB (VIEWER/WIRELESS/DC OUT)> terminal can supply power even in standby state. If set to [ECO], the <USB (VIEWER/WIRELESS/DC OUT)> terminal can not supply power in standby state.
- When an external device exceeding the rating (DC 5 V, maximum 2 A) is connected to the <USB (VIEWER/WIRELESS/DC OUT)> terminal, an error is detected and the power supply will be stopped. At this time, disconnect the external device, cut off the power of the projector and then reconnect the power plug to the outlet.
- When a LAN cable is directly connected to the projector, the network connection must be made indoors.
The signal may deteriorate due to the effect of noise or cable length.
- To transmit the Ethernet and serial control signals using the <DIGITAL LINK/LAN> terminal, set the [NETWORK] menu → [ETHERNET TYPE] to [DIGITAL LINK] or [LAN & DIGITAL LINK].
- To transmit the Ethernet signal using the <LAN> terminal, set the [NETWORK] menu → [ETHERNET TYPE] to [LAN] or [LAN & DIGITAL LINK].
- The <DIGITAL LINK/LAN> terminal and the <LAN> terminal are connected inside of the projector when the [NETWORK] menu → [ETHERNET TYPE] is set to [LAN & DIGITAL LINK]. Do not directly connect the <DIGITAL LINK/LAN> terminal and the <LAN> terminal using a LAN cable. Construct the system so that it is not connected to the same network via the peripherals such as the switching hub or the twisted-pair cable transmitter.

Preparing the remote control

Inserting and removing batteries

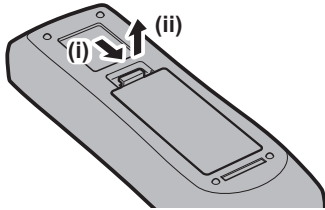

Fig. 1

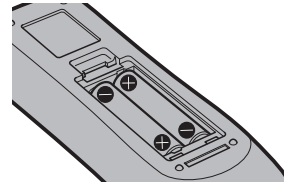

Fig. 2

- 1) Open the cover. (Fig. 1)
- 2) Insert batteries and close the cover (insert the "⊖" side first). (Fig. 2)
 - When removing the batteries, perform the steps in reverse order.

When using the system with multiple projectors

When you use the system with multiple projectors, you can operate all the projectors simultaneously or each projector individually by using single remote control, if a unique ID number is assigned to each projector.

When you want to set the ID number, at first you need to complete the Initial setting, and then after setting the ID number of the projector, set the ID number on the remote control. About Initial setting, please refer to "When the initial setting screen is displayed" (➡ page 47).

The factory default ID number of the unit (the projector and the remote control) is set to [ALL], you can control with this setting. If necessary, please set the ID number to the remote control and the projector. About how to set the ID number of the remote control, please refer to "Setting the ID number on the remote control" (➡ page 63).

Note

- Set the ID number of the projector from the [PROJECTOR SETUP] menu → [PROJECTOR ID] (➡ page 89).

Attaching the lens cap

When moving this projector or while not using it over an extended period of time, it is recommended to attach the lens cap to avoid contaminating the lens.

To prevent loss of the lens cap, please attach the lens cap with the string of accessories according to the following procedures.

- 1) Thread the thinner end of the string through the hole on the lens cap.

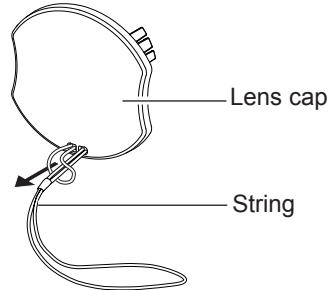

- 2) Thread the other side (the side with larger ring) of the string through the hole at the bottom of the projector and fasten it.

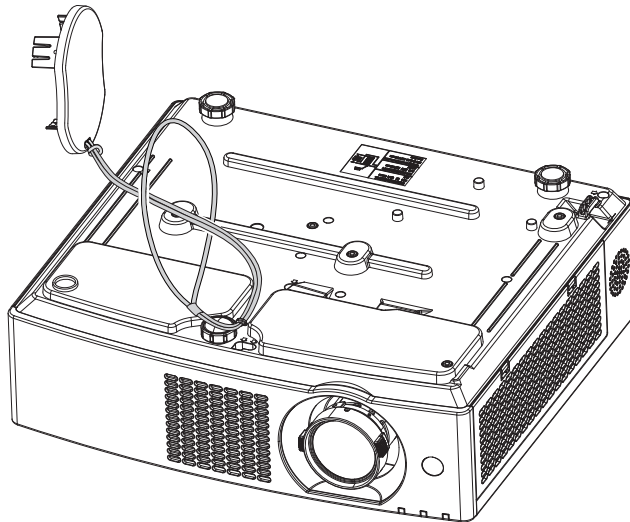

Chapter 2 **Getting Started**

This chapter describes things you need to do before using the projector such as the setup and connections.

Setting up

Installation mode

There are four ways to set up the projector. Set the [PROJECTOR SETUP] menu → [PROJECTION METHOD] (➔ page 90) depending on the installation mode.

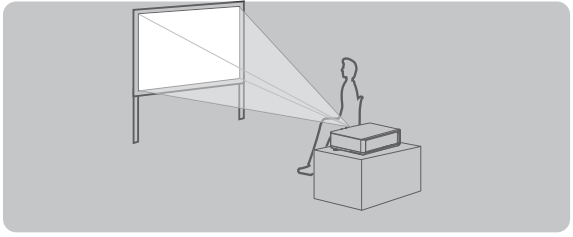
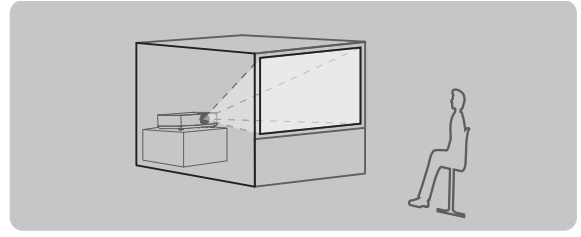
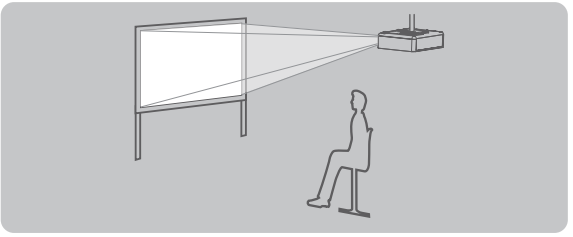
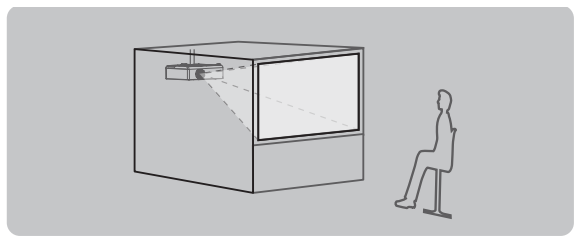
Setting on a desk/floor and projecting forward 		Setting on a desk/floor and projecting from rear (Using the translucent screen) 	
Menu item	Method	Menu item	Method
[PROJECTION METHOD]	[AUTO] or [FRONT/DESK]	[PROJECTION METHOD]	[REAR/DESK]
Mounting on the ceiling and projecting forward 		Mounting on the ceiling and projecting from rear (Using the translucent screen) 	
Menu item	Method	Menu item	Method
[PROJECTION METHOD]	[AUTO] or [FRONT/CEILING]	[PROJECTION METHOD]	[REAR/CEILING]

Note

- The projector has a built-in angle sensor. The attitude of the projector is automatically detected by setting the [PROJECTOR SETUP] menu → [PROJECTION METHOD] to [AUTO]. For rear projection, set the [PROJECTION METHOD] to [REAR/DESK] or [REAR/CEILING].

■ Angle sensor

The range of installation posture detected by the projector's built-in angle sensor is as follows.

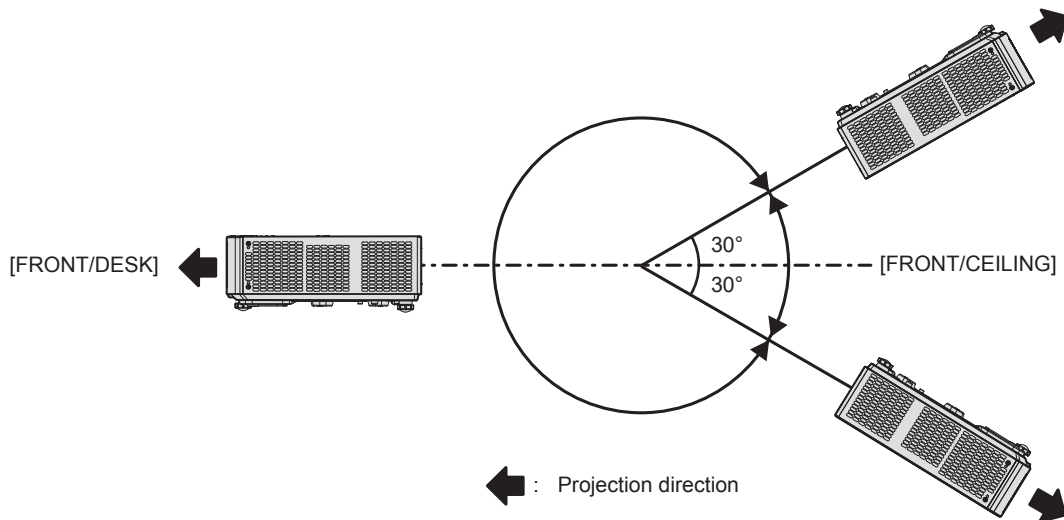

Parts for ceiling mount (optional)

This requires an optional ceiling mount bracket. Be sure to use the Projector Mount Bracket together with the ceiling mount bracket for high ceilings or low ceilings.

Model No.: ET-PKL100H (for high ceilings), ET-PKL100S (for low ceilings), ET-PKV400B (Projector Mount Bracket)

- Use only the ceiling mount brackets specified for this projector.
- Refer to the Installation Instructions for the ceiling mount bracket when you install the bracket and the projector.

Attention

- To ensure projector performance and security, installation of the ceiling mount bracket must be carried out by your dealer or a qualified technician.

Projected image and throw distance

Install the projector referring to the projected image size, projection distance, etc.

Attention

- Before setting up, read "Precautions for use" (➔ page 19).

Figure of projected image and throw distance

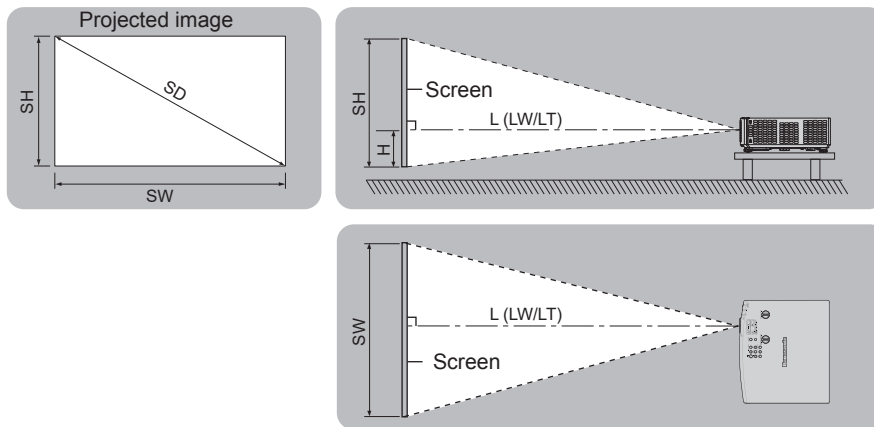

Note

- This illustration is prepared on the assumption that the projected image size and position have been aligned to fit full in the screen.
- This illustration is not in accurate scale.

L (LW/LT) *1	Projection distance
SH	Image height
SW	Image width
H	Distance from the center of lens to the image lower end
SD	Projected image size

*1 LW : Minimum distance
LT : Maximum distance

[SCREEN ADJUSTMENT] projection range

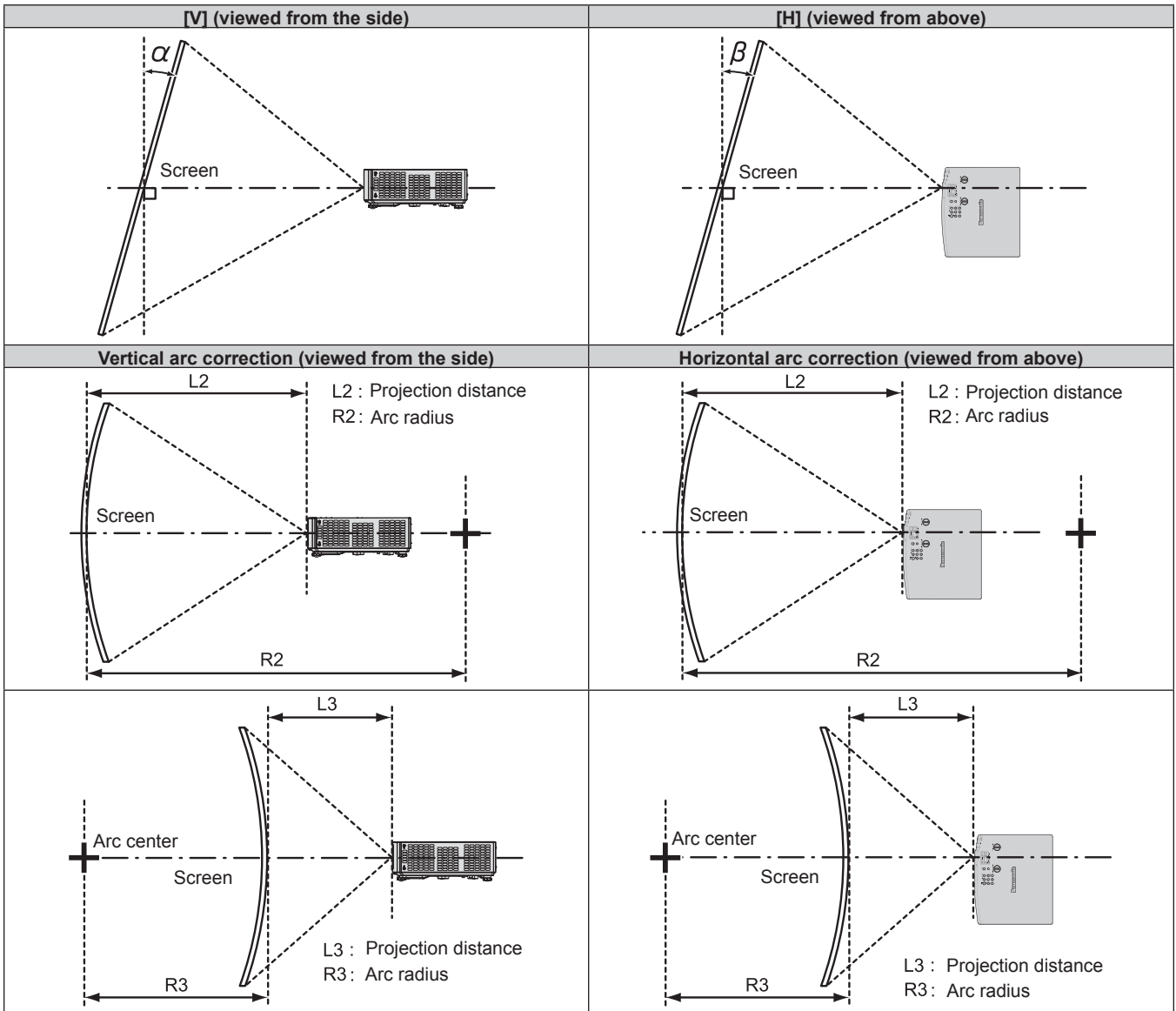

Model No.	Only [KEYSTONE] used		[KEYSTONE] and [CURVED CORRECTION] used together				Only [CURVED CORRECTION] used	
	Vertical keystone correction angle α (°)	Horizontal keystone correction angle β (°)	Vertical keystone correction angle α (°)	Horizontal keystone correction angle β (°)	Min. value of R2/L2	Min. value of R3/L3	Min. value of R2/L2	Min. value of R3/L3
PT-VMZ71 PT-VMZ61 PT-VMZ51 PT-VMZ51S PT-VMZ41	±25	±35	±25	±35	1.4	2.9	0.7	1.6
PT-VMW61 PT-VMW51	±35	±35	±35	±35	1.4	2.9	0.7	1.6

Note

- When [SCREEN ADJUSTMENT] is used, the focus may not be able to match the whole screen as correction increases.
- The curved screen should be in the shape of a circular arc part of a perfect circle.

Projection distance

An error of $\pm 5\%$ may occur to the projection distance as described.

Also, it is corrected to become smaller than the specified image size when [SCREEN ADJUSTMENT] is used.

Note

- The display resolution may decrease when the Digital Zoom Extender function is used. In addition, 6-point screen correction, keystone correction and curved-screen correction cannot be used, and the adjustable range of corner correction is reduced.
- For details on Digital Zoom Extender function, refer to the [POSITION] menu → [SCREEN ADJUSTMENT] → [DIGITAL ZOOM EXTENDER] (➡ page 74).

■ When the screen aspect ratio is 16:10

(Unit: m)

Throw ratio	Optical zoom 1.09-1.77:1		Digital Zoom Extender *1 1.09-2.21:1 (converted value)	Distance from the lens center to the image lower end (H) *2
	Minimum distance (LW)	Maximum distance (LT)	Maximum distance (LT)	
0.76 (30")	0.68	1.12	1.40	0.022 ~ 0.201
1.02 (40")	0.93	1.51	1.89	0.030 ~ 0.270
1.27 (50")	1.16	1.89	2.37	0.037 ~ 0.337
1.52 (60")	1.39	2.26	2.84	0.045 ~ 0.403
1.78 (70")	1.64	2.66	3.33	0.052 ~ 0.472
2.03 (80")	1.87	3.03	3.80	0.060 ~ 0.538
2.29 (90")	2.12	3.43	4.29	0.067 ~ 0.607
2.54 (100")	2.35	3.80	4.76	0.075 ~ 0.673
3.05 (120")	2.83	4.57	5.73	0.090 ~ 0.808
3.81 (150")	3.54	5.72	7.16	0.112 ~ 1.010
5.08 (200")	4.73	7.64	9.56	0.150 ~ 1.346
6.35 (250")	5.92	9.56	11.96	0.187 ~ 1.683
7.62 (300")	7.11	11.48	14.35	0.224 ~ 2.019

*1 When optical zoom and Digital Zoom Extender are used together and [DIGITAL ZOOM EXTENDER] is set to [80%].

*2 Only for optical zoom

■ When the screen aspect ratio is 16:9

(Unit: m)

Throw ratio	Optical zoom 1.09-1.77:1		Digital Zoom Extender *1 1.09-2.21:1 (converted value)	Distance from the lens center to the image lower end (H) *2
	Minimum distance (LW)	Maximum distance (LT)	Maximum distance (LT)	
0.76 (30")	0.70	1.15	1.44	0.002 ~ 0.186
1.02 (40")	0.95	1.55	1.95	0.003 ~ 0.250
1.27 (50")	1.19	1.94	2.43	0.004 ~ 0.311
1.52 (60")	1.43	2.33	2.92	0.005 ~ 0.372
1.78 (70")	1.69	2.73	3.42	0.005 ~ 0.436
2.03 (80")	1.93	3.12	3.91	0.006 ~ 0.497
2.29 (90")	2.18	3.52	4.41	0.007 ~ 0.561
2.54 (100")	2.42	3.91	4.90	0.008 ~ 0.622
3.05 (120")	2.91	4.70	5.89	0.009 ~ 0.747
3.81 (150")	3.64	5.88	7.36	0.012 ~ 0.933
5.08 (200")	4.86	7.85	9.83	0.015 ~ 1.245
6.35 (250")	6.09	9.83	12.29	0.019 ~ 1.556
7.62 (300")	7.31	11.80	14.75	0.023 ~ 1.867

*1 When optical zoom and Digital Zoom Extender are used together and [DIGITAL ZOOM EXTENDER] is set to [80%].

*2 Only for optical zoom

■ When the screen aspect ratio is 4:3

(Unit: m)

Throw ratio	Optical zoom 1.31-2.12:1		Digital Zoom Extender *1 1.31-2.66:1 (converted value)	Distance from the lens center to the image lower end (H) *2
	Minimum distance (LW)	Maximum distance (LT)	Maximum distance (LT)	
0.76 (30")	0.78	1.27	1.59	0.025 ~ 0.228
1.02 (40")	1.05	1.71	2.15	0.034 ~ 0.306
1.27 (50")	1.32	2.14	2.68	0.042 ~ 0.381
1.52 (60")	1.58	2.57	3.22	0.051 ~ 0.456
1.78 (70")	1.86	3.01	3.77	0.059 ~ 0.534
2.03 (80")	2.12	3.44	4.31	0.068 ~ 0.609
2.29 (90")	2.40	3.88	4.86	0.076 ~ 0.687
2.54 (100")	2.67	4.31	5.40	0.085 ~ 0.762
3.05 (120")	3.21	5.18	6.49	0.102 ~ 0.915
3.81 (150")	4.01	6.48	8.11	0.127 ~ 1.143
5.08 (200")	5.36	8.65	10.83	0.169 ~ 1.524
6.35 (250")	6.71	10.83	13.54	0.212 ~ 1.905
7.62 (300")	8.05	13.00	16.25	0.254 ~ 2.286

*1 When optical zoom and Digital Zoom Extender are used together and [DIGITAL ZOOM EXTENDER] is set to [80%].

*2 Only for optical zoom

Projection distance formulas

To use a projected image size not listed in this manual, check the projected image size SD (m) and use the respective formula to calculate the value.

The unit of all the formulae is m. (Values obtained by the following calculation formulae contain a slight error.)

When calculating the value using image size designation (value in inches), multiply the value in inches by 0.0254 and substitute it into SD in the formula.

Aspect ratio		16:10	16:9	4:3	
Screen height (SH)		= 0.530 × SD	= 0.490 × SD	= 0.6 × SD	
Screen width (SW)		= 0.848 × SD	= 0.872 × SD	= 0.8 × SD	
Projection distance (L) ^{*1}	Optical zoom	Minimum (LW)	= 0.9371 × SD - 0.0294	= 0.9632 × SD - 0.0294	= 1.0609 × SD - 0.0294
		Maximum (LT)	= 1.5103 × SD - 0.0319	= 1.5523 × SD - 0.0319	= 1.7098 × SD - 0.0319
	Digital Zoom Extender	Minimum (LW)	= 0.9371 × SD / X - 0.0294	= 0.9632 × SD / X - 0.0294	= 1.0609 × SD / X - 0.0294
		Maximum (LT)	= 1.5103 × SD / X - 0.0319	= 1.5523 × SD / X - 0.0319	= 1.7098 × SD / X - 0.0319

*1 X in the formulas represents the setting value of [DIGITAL ZOOM EXTENDER] (100%=1.00, 95%=0.95, 90%=0.90, 85%=0.85, 80%=0.80).

Connecting

Before connecting

- Before connecting, carefully read the operating instructions for the external device to be connected.
- Turn off the power switch of the devices before connecting cables.
- Connect cables taking care of the following descriptions. Failure to do so may result in malfunctions.
 - When connecting a cable to the projector or an external device connected to the projector, touch any nearby metallic objects to eliminate static electricity from your body before performing work.
 - Do not use unnecessarily long cables to connect to the projector or a device connected to the projector. The longer the cable, the more it is susceptible to noise. Since using a cable while it is wound makes it act like an antenna, it is more susceptible to noise.
 - When connecting cables, connect GND first, then insert the connecting terminal of the connecting device straightly.
- If any connection cable is not supplied with the device, or if no optional cable is available for connection of the device, prepare a necessary system connection cable to suit the device.
- Image signals from the video devices containing too much jitter may cause the images on the screen to randomly wobble or wafture. In this case, a time base corrector (TBC) must be connected.
- Some computer models or graphics cards are not compatible with the projector.
- Connect using an extension device, etc., when installing the projector away from the video equipment. The projector may not display the image properly when it is connected directly using a long cable.
- For details on what image signals the projector supports, refer to “List of compatible signals” (➔ page 168).

Connecting example: AV equipment

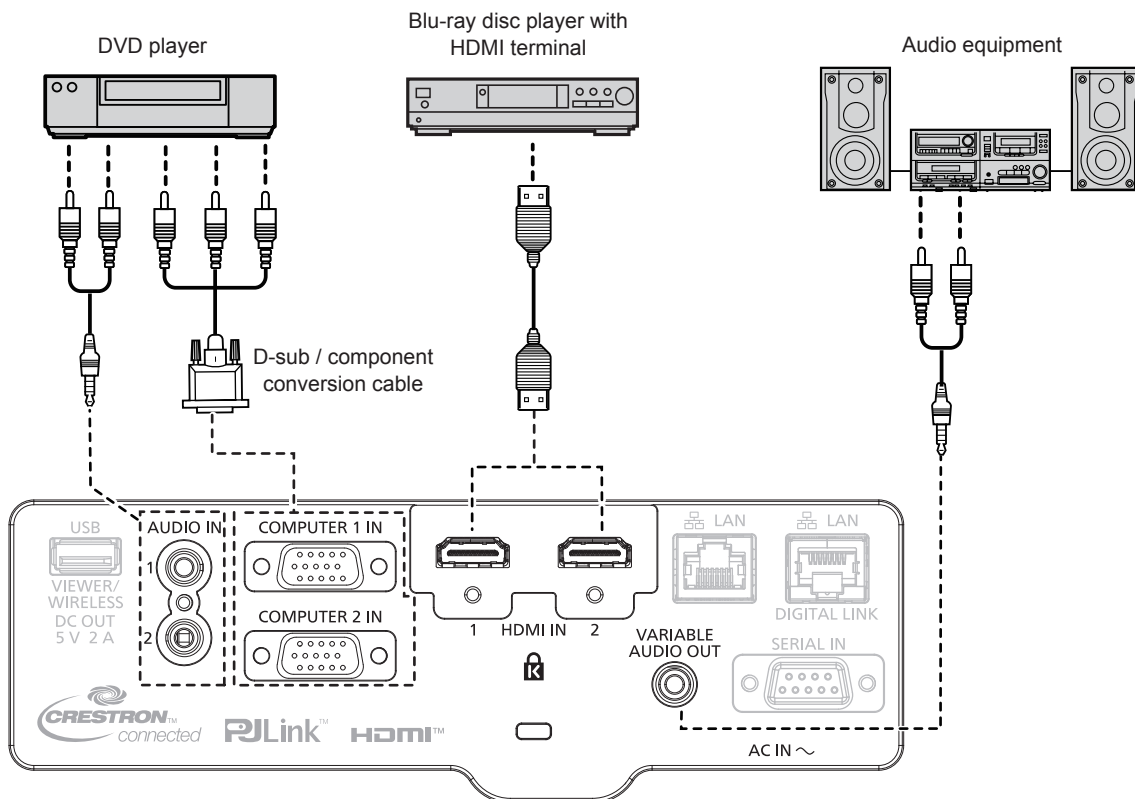

Note

- For an HDMI cable, use an HDMI High Speed cable that conforms to HDMI standards. In addition, when 4K image signal is to be input, please use HDMI cable that is compatible with 4K image signal. Images may be disrupted or may not be projected when an image signal exceeding the supported transmission speed of the HDMI cable is input.
- The <HDMI IN 1> terminal / <HDMI IN 2> terminal can be connected to an external device with the DVI-D terminal by using an HDMI/DVI conversion cable. However, this may not function properly for some external devices, and image may not be projected.
- To output audio, properly set the [PROJECTOR SETUP] menu → [AUDIO SETTING] → [AUDIO IN SELECT].
- When the <VARIABLE AUDIO OUT> terminal is connected with cable, the sound will not be output from the built-in speaker.

Connecting example: Computers

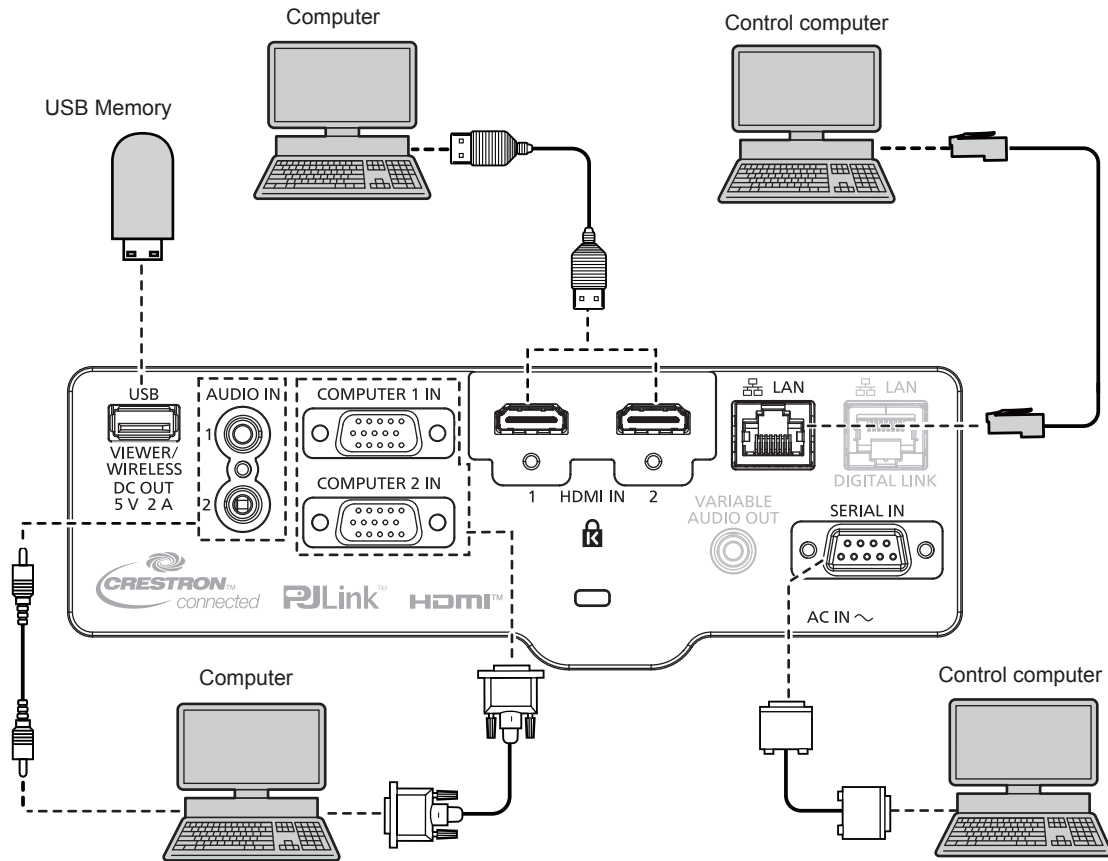

Attention

- When connecting the projector to a computer or an external device, use the power cord supplied with each device and commercially available shielded cables.

Note

- For the HDMI cable, use an HDMI High Speed cable that conforms to the HDMI standards. In addition, when 4K image signal is to be input, please use HDMI cable that is compatible with 4K image signal. Images may be disrupted or may not be projected when an image signal exceeding the supported transmission speed of the HDMI cable is input.
- The <HDMI IN 1> terminal /<HDMI IN 2> terminal can be connected to an external device with the DVI-D terminal by using an HDMI/DVI conversion cable. However, this may not function properly for some external devices, and image may not be projected.
- If you operate the projector using the computer with the resume feature (last memory), you may have to reset the resume feature to operate the projector.

Connecting example: Using DIGITAL LINK

(Not available for PT-VMZ51S and PT-VMZ41)

Twisted-pair-cable transmitter based on the communication standard HDBaseT™ such as the optional DIGITAL LINK output supported device (Model No.: ET-YFB100G, ET-YFB200G) uses the twisted pair cable to transmit input images, audio, Ethernet, and serial control signal, and the projector can input such digital signal to the <DIGITAL LINK/LAN> terminal.

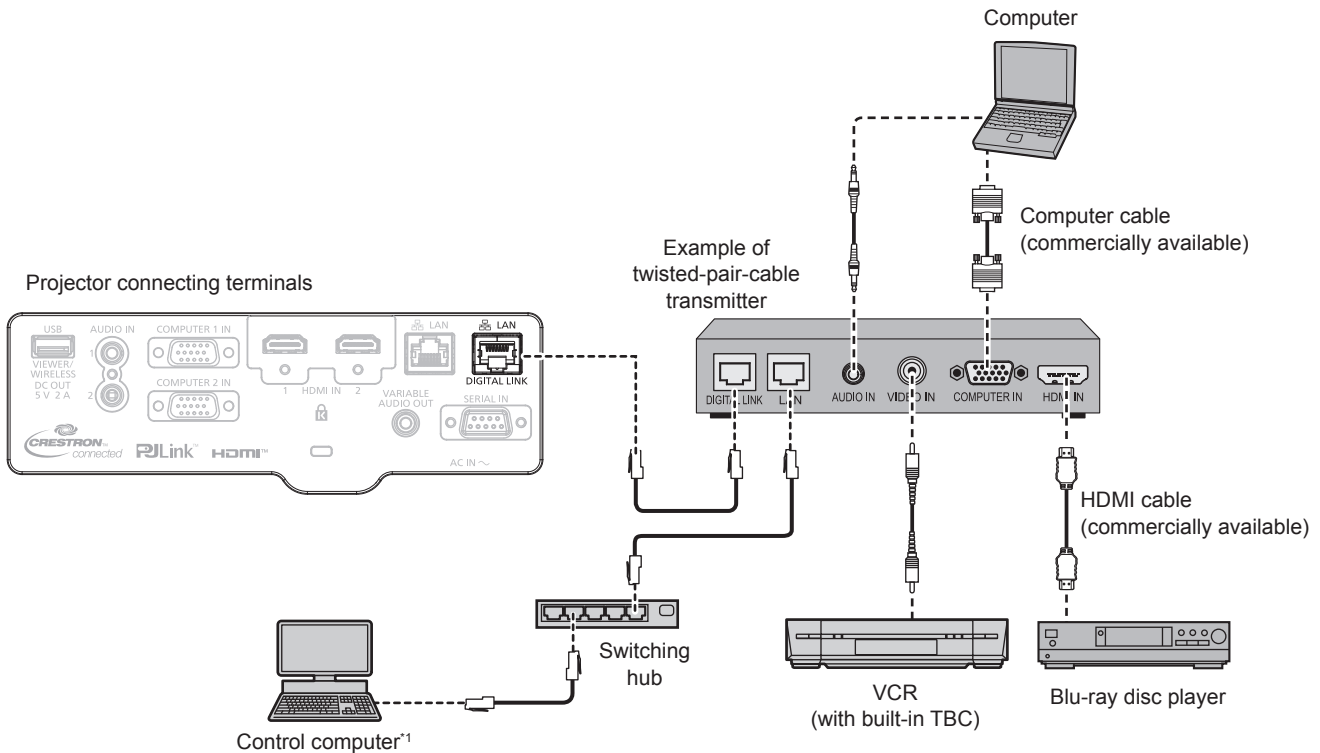

*1 Control target is the projector or the twisted-pair-cable transmitter. The control itself may not be possible depending on the twisted-pair-cable transmitter. Check the operating instructions of the device to be connected.

Attention

- Always use one of the following when connecting a VCR.
 - A VCR with built-in time base corrector (TBC)
 - A time base corrector (TBC) between the projector and the VCR
- If nonstandard burst signals are connected, the image may be distorted. In such case, connect the time base corrector (TBC) between the projector and the external devices.
- Ask a qualified technician or your dealer to install the cable wiring for a twisted-pair-cable transmitter and the projector. The image may be disrupted if cable transmission characteristics cannot be obtained due to inadequate installation.
- For the LAN cable between a twisted-pair-cable transmitter and the projector, use a cable that meets the following criteria:
 - Compatible with CAT5e or higher
 - Shielded type (including connectors)
 - Straight-through
 - Single wire
 - Diameter of the cable core is same or larger than AWG24 (AWG24, AWG23, etc.)
- When laying cables between a twisted-pair-cable transmitter and the projector, check that cable characteristics are compatible with CAT5e or higher using tools such as a cable tester or cable analyzer.
- When using a relay connector midway, include it in the measurement.
- Do not use a switching hub between a twisted-pair-cable transmitter and the projector.
- When connecting to the projector using a twisted-pair-cable transmitter (receiver) of other manufacturer, do not place another twisted-pair-cable transmitter between the twisted-pair-cable transmitter of other manufacturer and the projector. This may cause image and sound to be disrupted.
- To transmit the Ethernet and serial control signals using the <DIGITAL LINK/LAN> terminal, set the [NETWORK] menu → [ETHERNET TYPE] to [DIGITAL LINK] or [LAN & DIGITAL LINK].
- To transmit the Ethernet signal using the <LAN> terminal, set the [NETWORK] menu → [ETHERNET TYPE] to [LAN] or [LAN & DIGITAL LINK].
- The <DIGITAL LINK/LAN> terminal and the <LAN> terminal are connected inside of the projector when the [NETWORK] menu → [ETHERNET TYPE] is set to [LAN & DIGITAL LINK]. Do not directly connect the <DIGITAL LINK/LAN> terminal and the <LAN> terminal using a LAN cable. Construct the system so that it is not connected to the same network via the peripherals such as the switching hub or the twisted-pair-cable transmitter.
- Do not pull cables forcefully. Also, do not bend or fold cables unnecessarily.
- To reduce the effects of noise as much as possible, stretch out the cables between the twisted-pair-cable transmitter and the projector without any loops.
- Lay the cables between a twisted-pair-cable transmitter and the projector away from other cables, particularly power cables.
- When installing multiple cables, run them side by side along the shortest distance possible without bundling them together.

- After laying the cable, confirm that the value of [SIGNAL QUALITY] in the [NETWORK] menu → [DIGITAL LINK] → [DIGITAL LINK STATUS] is displayed in green, which indicates a normal quality. (➡ page 104)

Note

- For an HDMI cable, use an HDMI High Speed cable that conforms to HDMI standards. If a cable that does not conform to HDMI standards is used, images may be interrupted or may not be displayed.
- The optional Digital Interface Box (Model No.: ET-YFB100G) and the optional DIGITAL LINK Switcher (Model No.: ET-YFB200G) do not support the input and output of the 4K image signal.
- The maximum transmission distance between the twisted-pair-cable transmitter and the projector is 100 m (328'1") for the signal with resolution of 1 920 x 1 200 dots or less. For the signal with the resolution exceeding 1 920 x 1 200 dots, the maximum transmission distance is 50 m (164'1"). It is possible to transmit up to 150 m (492'2") if the twisted-pair-cable transmitter supports the long-reach communication method. However, the signal that the projector can receive is only up to 1080/60p (1 920 x 1 080 dots, dot clock frequency 148.5 MHz) for the long-reach communication method. If these distances are exceeded, image may be disrupted or a malfunction may occur in LAN communication. Please note that Panasonic Connect Co., Ltd. does not support the use of the projector outside the maximum transmission distance. When connecting with the long reach, image signal or distance that can be transmitted may be restricted, depending on the specification of the twisted-pair-cable transmitter.
- For twisted-pair-cable transmitter of other manufacturers of which the operation has been verified with the DIGITAL LINK compatible projector, refer to website (<https://panasonic.net/cns/projector/>). Note that the verification for devices of other manufacturers has been made for the items set by Panasonic Connect Co., Ltd., and not all the operations have been verified. For operation or performance problems caused by the devices of other manufacturers, contact the respective manufacturers.

Chapter 3 **Basic Operations**

This chapter describes basic operations to start with.

Switching on/off the projector

Connecting the power cord

Make sure that the supplied power cord is securely fixed to the projector body to prevent it from being removed easily.

For details of power cord handling, refer to “Read this first!”. (➔ page 4)

Attaching the power cord

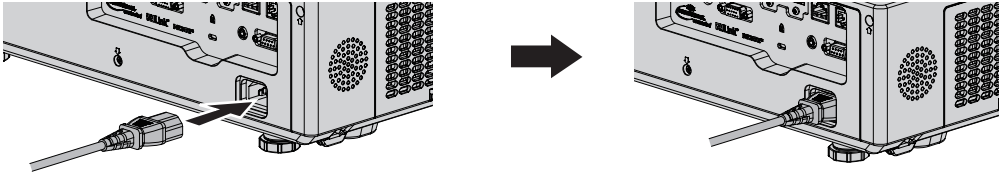

- 1) Check the shapes of the <AC IN> terminal on the back of the projector and the power cord connector, then insert the connector completely in the correct direction.

Removing the power cord

- 1) Confirm that the projector is in standby mode, and remove the power plug from the outlet.
- 2) Remove the power cord connector from the <AC IN> terminal.

Power indicator

Displays the status of the power. Check the <ON(G)/STANDBY(R)> status of the power indicator before operating the projector.

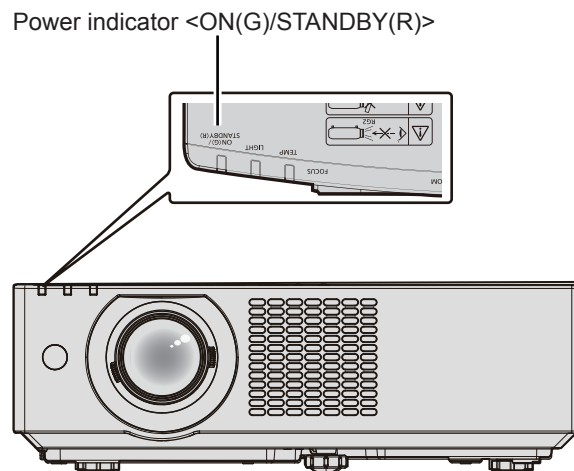

Chapter 3 Basic Operations - Switching on/off the projector

Indicator status		Projector status
	Off	The power plug is not connected to the outlet.
Red	Lit	<p>The power is switched off (in standby mode). Projection will start when the power <⏻/> button is pressed.</p> <ul style="list-style-type: none"> The setting of the projector is as follows. <ul style="list-style-type: none"> The [PROJECTOR SETUP] menu → [ECO MANAGEMENT] → [STANDBY MODE] is set to [ECO] When the light source indicator <LIGHT> or the temperature indicator <TEMP> is blinking, the projection will not start even if the power <⏻/> button is pressed. (➡ page 146)
	Blinking ^{*1}	<p>The power is switched off (in standby mode). Projection will start when the power <⏻/> button is pressed.</p> <ul style="list-style-type: none"> The standby power consumption is high. The projector is set as follows <ul style="list-style-type: none"> The [PROJECTOR SETUP] menu → [ECO MANAGEMENT] → [STANDBY MODE] is set to [NORMAL] and any one or both of the following setting is met. <ul style="list-style-type: none"> The [PROJECTOR SETUP] menu → [ECO MANAGEMENT] → [QUICK STARTUP] is set to [ON] The [PROJECTOR SETUP] menu → [AUDIO SETTING] → [IN STANDBY MODE] is set to [ON] The indicator will change to a red light when the specified time has elapsed after the projector enters the standby mode if the projector is set as following. The specified time is a time set in the [PROJECTOR SETUP] menu → [ECO MANAGEMENT] → [QUICK STARTUP] → [VALID PERIOD]. <ul style="list-style-type: none"> The [PROJECTOR SETUP] menu → [ECO MANAGEMENT] → [QUICK STARTUP] is set to [ON] The [PROJECTOR SETUP] menu → [AUDIO SETTING] → [IN STANDBY MODE] is set to [OFF] When the light source indicator <LIGHT> or the temperature indicator <TEMP> is blinking, the projection will not start even if the power <⏻/> button is pressed. (➡ page 146)
	Blinking ^{*2}	<p>The power is switched off (in standby mode). Projection will start when the power <⏻/> button is pressed.</p> <ul style="list-style-type: none"> The standby power consumption is high. The projector is set to the following settings. <ul style="list-style-type: none"> The [PROJECTOR SETUP] menu → [ECO MANAGEMENT] → [STANDBY MODE] is set to [NORMAL] The [PROJECTOR SETUP] menu → [ECO MANAGEMENT] → [QUICK STARTUP] is set to [OFF] The [PROJECTOR SETUP] menu → [AUDIO SETTING] → [IN STANDBY MODE] is set to [OFF] When the light source indicator <LIGHT> or the temperature indicator <TEMP> is blinking, the projection will not start even if the power <⏻/> button is pressed. (➡ page 146)
Green	Lit	Projecting.
	Blinking ^{*3}	<p>The light source is turned off due to the [POWER MANAGEMENT] setting. The projector lights up and begins to project when a signal is input or a button operation is performed.</p> <ul style="list-style-type: none"> The setting of the projector is as follows. <ul style="list-style-type: none"> The [PROJECTOR SETUP] menu → [ECO MANAGEMENT] → [POWER MANAGEMENT] is set to [READY].
	Blinking ^{*4}	<p>The light source is turned off because the shutter function is in use (shutter: closed). The projector lights up and begins to project when you press the <SHUTTER> button on the remote control or the control panel.</p>
Orange	Lit	<p>The projector is preparing to be switched off. The power will be switched off after a while. (Changes to the standby mode.)</p>

*1 The indicator flashes in the cycle: 0.5 seconds (light) → 0.5 seconds (off)

*2 The indicator flashes in the cycle: 2.75 seconds (light) → 0.25 seconds (off)

*3 The indicator flashes in the cycle: 2.0 seconds (light) → 2.0 seconds (off)

*4 The indicator flashes in the cycle: 0.75 seconds (light) → 0.75 seconds (off)

Note

- While the power indicator <ON (G)/STANDBY (R)> lights orange, the fan is running to cool the projector.
- For approximately five seconds after the projector is turned off, the indicator does not light up even if the power is turned on. Turn on the power again after the power indicator <ON (G)/STANDBY (R)> lights/blinks red.
- The projector consumes power even in standby mode (power indicator <ON (G)/STANDBY (R)> lights/blinks red). Refer to "Maximum power consumption" (➡ page 165) for the power consumption.
- The power indicator <ON (G)/STANDBY (R)> will blink if the projector receives a remote control signal.

Switching on the projector

Before switching on the projector, make sure all the other devices are correctly connected (➔ page 40). Remove the lens cap beforehand.

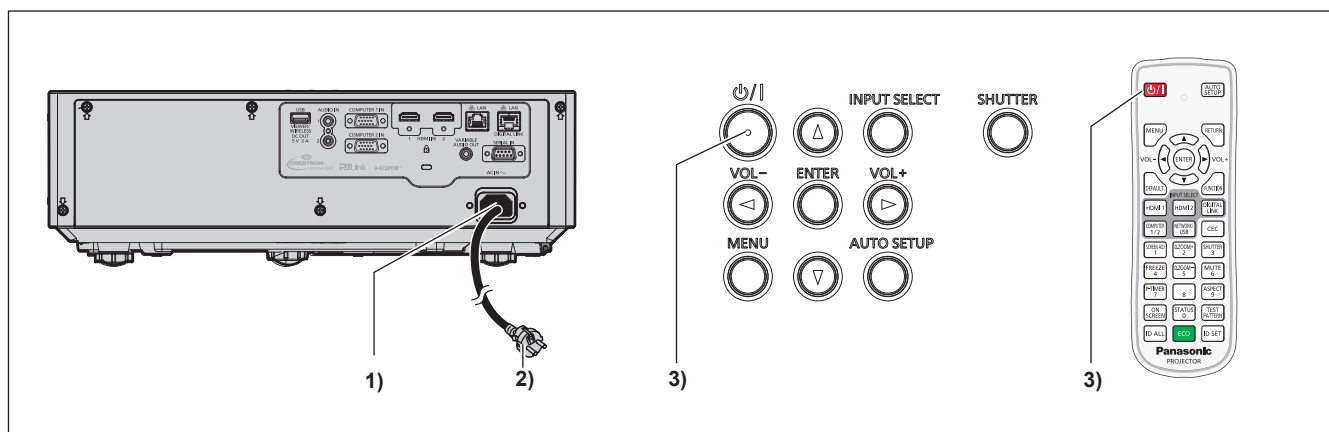

- 1) **Connect the power cord to the projector.**
- 2) **Connect the power plug to an outlet.**
 - The power indicator <ON(G)/STANDBY(R)> lights/blinks, and the projector will enter the standby mode.
- 3) **Press the power <⏻/|> button.**
 - The power indicator <ON(G)/STANDBY(R)> lights green and the image is soon projected on the screen.

Attention

- Be sure to remove the lens cap before starting projection.

Note

- When the [PROJECTOR SETUP] menu → [ECO MANAGEMENT] → [STANDBY MODE] is set to [ECO], it takes longer for the projection to start after the power is turned on, compared to when set to [NORMAL].
- When the [PROJECTOR SETUP] menu → [ECO MANAGEMENT] → [QUICK STARTUP] is set to [ON], and the power is turned on before the specified time elapses after the projector enters the standby mode, an image will be projected approximately one second after the power is turned on.
The specified time is a time set in the [PROJECTOR SETUP] menu → [ECO MANAGEMENT] → [QUICK STARTUP] → [VALID PERIOD].

When the initial setting screen is displayed

When the projector is switched on for the first time after purchase, the **[INITIAL SETTING]** screen and the **[ADMINISTRATOR ACCOUNT]** screen are displayed in order after the projection starts. When the [PROJECTOR SETUP] menu → [INITIALIZE ALL] is executed, the **[INITIAL SETTING]** screen is displayed after the projection starts. When the [NETWORK] menu → [INITIALIZE] is executed, the **[ADMINISTRATOR ACCOUNT]** screen is displayed after the projection starts next time. Set them in accordance with circumstances.

In other occasions, you can change the settings by menu operations.

When the **[INITIAL SETTING]** screen is displayed, you can return to the previous screen by pressing the <MENU> button or <RETURN> button.

Note

- When the projector is used for the first time, in order to clearly display the menu screen, it may be necessary to adjust the focus lever and the zoom lever in the projection lens area of the projector (➔ page 29). For details, refer to "Adjusting the focus, zoom, and lens shift" (➔ page 55).

Initial setting (display language)

Select the language to show on the screen.

After the initial setting, you can change the display language from the [LANGUAGE] menu.

- 1) **Press ▲▼◀▶ to select the display language.**



2) Press the <ENTER> button to proceed to the following initial setting.

Initial setting (projector setup)

If necessary, change the setting of each item.

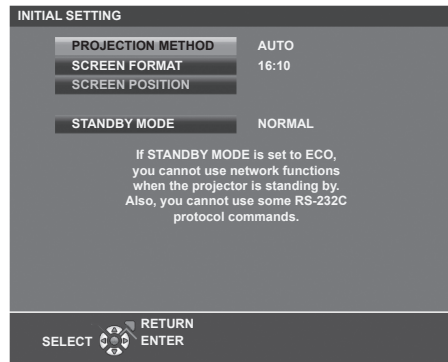

1) Press ▲▼ to select an item.

Item	Description
[PROJECTION METHOD]	Set [PROJECTION METHOD] depending on the installation mode.
[SCREEN FORMAT]	Set the aspect ratio of the screen.
[SCREEN POSITION]	Set the display position of the screen.
[STANDBY MODE]	Set the operation mode during standby.

2) Press ◀▶ to switch the setting.

- When all settings are completed, proceed to Step 3).

3) Press the <ENTER> button.

- Confirm the setting value and complete the initial setting.

Setting [PROJECTION METHOD]

If the screen display is upside down or is reversed, please change the settings, refer to “Installation mode” (➔ page 35). After initialization, you can change the settings from the [PROJECTOR SETUP] menu → [PROJECTION METHOD].

1) Press ▲▼ to select the [PROJECTION METHOD].

2) Press ◀▶ to switch the settings.

- When set to [AUTO], the built-in angle sensor detects the orientation of the projector and automatically switches to [FRONT/DESK] or [FRONT/CEILING]. Normally, set to [AUTO].
- To project from the rear of the screen, select [REAR/DESK] or [REAR/CEILING] (using a translucent screen).

Setting [SCREEN FORMAT] and [SCREEN POSITION]

Set the screen aspect ratio and display position according to the screen being used. When the initial setting is complete, you can change the setting from the [DISPLAY OPTION] menu → [SCREEN SETTING] → [SCREEN FORMAT]/[SCREEN POSITION].

- 1) Press ▲▼ to select the [SCREEN FORMAT].
- 2) Press ◀▶ to select the aspect ratio.
- 3) Press ▲▼ to select the [SCREEN POSITION].
 - When [SCREEN FORMAT] is set to [16:10], the [SCREEN POSITION] cannot be changed.
 - When [SCREEN FORMAT] is set to [16:9] or [4:3], proceeds to Step 4).
- 4) Press ◀▶ to select the image position.
 - Select from [CENTER]/[HIGH]/[LOW] or [CENTER]/[LEFT]/[RIGHT].

Setting [STANDBY MODE]

Set the operating mode at standby. When the initial setting is complete, you can change the setting from the [PROJECTOR SETUP] menu → [ECO MANAGEMENT] → [STANDBY MODE].

- 1) Press ▲▼ to select [STANDBY MODE].
- 2) Press ◀▶ to select the operation mode.
 - The factory default setting is [NORMAL], which enables the network function even in standby mode.
 - To lower the power consumption level during standby, set to [ECO].

When the administrator account setting screen is displayed

When the projector is switched on for the first time after purchase, the [INITIAL SETTING] screen and the [ADMINISTRATOR ACCOUNT] screen are displayed in order after the projection starts. When the [PROJECTOR SETUP] menu → [INITIALIZE ALL] is executed, the [INITIAL SETTING] screen is displayed after the projection starts. When the [NETWORK] menu → [INITIALIZE] is executed, the [ADMINISTRATOR ACCOUNT] screen is displayed after the projection starts next time.

To use the network function of this projector, set the user name and password of the administrator account. You can also set it later from the [NETWORK] menu → [ADMINISTRATOR ACCOUNT].

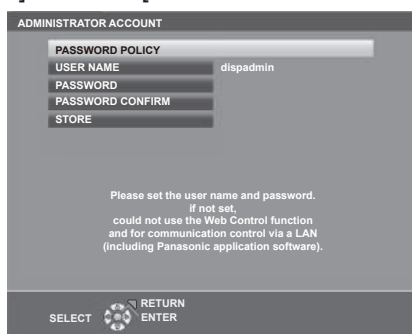

[PASSWORD POLICY]

Displays the policies about the password for the administrator account.

- 1) Press ▲▼ to select [PASSWORD POLICY], and press the <ENTER> button.
 - The [PASSWORD POLICY] screen is displayed.
 - Pressing the <MENU> button can return to the [ADMINISTRATOR ACCOUNT] screen.

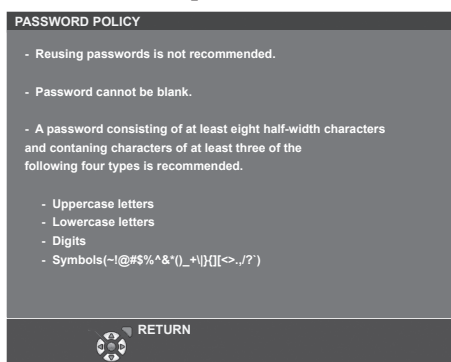

Setting the administrator account

Set the user name and password of the administrator account.

- 1) Press **▲▼** to select [USER NAME], and press the <ENTER> button.
 - The [USER NAME] screen is displayed.
 - The factory default setting of user name is “dispadmin”.
- 2) Press **▲▼◀▶** to select a character, and press the <ENTER> button.
 - Up to 16 characters can be entered.
- 3) After entering the user name, press **▲▼◀▶** to select [OK], and press the <ENTER> button.
 - The [ADMINISTRATOR ACCOUNT] screen is displayed.
- 4) Press **▲▼** to select [PASSWORD], and press the <ENTER> button.
 - The [PASSWORD] screen is displayed.
- 5) Press **▲▼◀▶** to select a character, and press the <ENTER> button.
 - Up to 16 characters can be entered.
 - The password cannot be blank.
- 6) After entering the password, press **▲▼◀▶** to select [OK], and press the <ENTER> button.
 - The [ADMINISTRATOR ACCOUNT] screen is displayed.
- 7) Press **▲▼** to select [PASSWORD CONFIRM], and press the <ENTER> button.
 - The [PASSWORD CONFIRM] screen is displayed.
- 8) Enter the password entered in Step 5).
- 9) After entering the password, press **▲▼◀▶** to select [OK], and press the <ENTER> button.
 - The [ADMINISTRATOR ACCOUNT] screen is displayed.
- 10) Press **▲▼** to select [STORE], and press the <ENTER> button.
 - The confirmation screen is displayed.
- 11) Press **◀▶** to select [OK], and press the <ENTER> button.

Note

- For restrictions on character strings that can be set for password, refer to [PASSWORD POLICY] (➔ page 49).
- By pressing the <MENU> button while the [ADMINISTRATOR ACCOUNT] screen is displayed, you can proceed to the next operation without setting an administrator account password, but the network function of this projector cannot be used. To use the web control function or the communication control (including operation with application software) via LAN, set a password.
- If you press the <MENU> button while the [ADMINISTRATOR ACCOUNT] screen is displayed, the [ADMINISTRATOR ACCOUNT] screen will not be displayed the next time the power is turned on. To use the network function, set a password in the [NETWORK] menu → [ADMINISTRATOR ACCOUNT].
- The user name and password of the administrator account can also be changed on the [Set up password] page (➔ page 139) of the web control screen.
- The user name and password of the standard user account without administrator rights can be set on the [Set up password] page (➔ page 139) of the web control screen.

Making adjustments and selections

It is recommended that images are projected continuously for at least 30 minutes before the focus is adjusted.

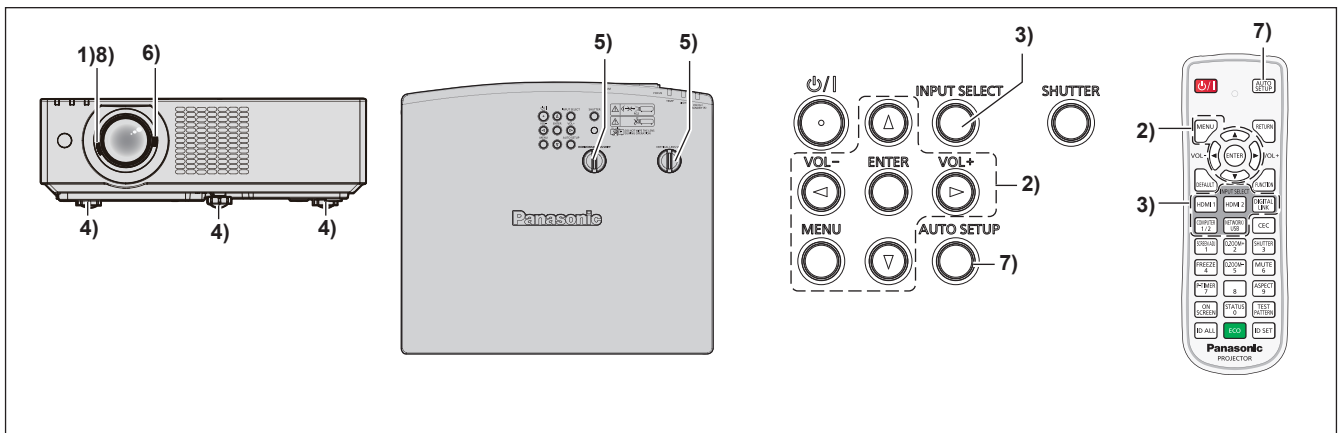

- 1) Roughly adjust the focus of the image with the focus lever. (➡ page 55)
- 2) Change the settings of the [PROJECTOR SETUP] menu → [PROJECTION METHOD] depending on the installation mode. (➡ page 35)
 - Refer to “Navigating through the menu” (➡ page 65) for the operation of the menu screen.
- 3) Press the input selection buttons on the remote control or the <INPUT SELECT> button on the control panel to select the input signal.
 - The buttons that can be used on the remote control are as follows.
 <HDMI 1> button, <HDMI 2> button, <DIGITAL LINK>*1 button, <COMPUTER 1/2> button, <NETWORK/USB> button
- *1 Not available for the remote control supplied with PT-VMZ51S and PT-VMZ41.
- 4) Adjust the front, back and sideway tilt of the projector with the adjustable feet. (➡ page 55)
- 5) Adjust the horizontal / vertical projection position with the horizontal / vertical lens shift dial. (➡ page 55)
- 6) Adjust the size of the image to match the screen with the zoom lever. (➡ page 55)
- 7) If the input signal is an analog RGB signal, press the <AUTO SETUP> button.
- 8) Adjust the focus again with the focus lever.

Note

- When the projector is switched on for the first time after purchase, the [INITIAL SETTING] screen and the [ADMINISTRATOR ACCOUNT] screen are displayed in order after the projection starts. When the [PROJECTOR SETUP] menu → [INITIALIZE ALL] is executed, the [INITIAL SETTING] screen is displayed after the projection starts. When the [NETWORK] menu → [INITIALIZE] is executed, the [ADMINISTRATOR ACCOUNT] screen is displayed after the projection starts next time. For details, refer to “When the initial setting screen is displayed” (➡ page 47) and “When the administrator account setting screen is displayed” (➡ page 49).

Switching off the projector

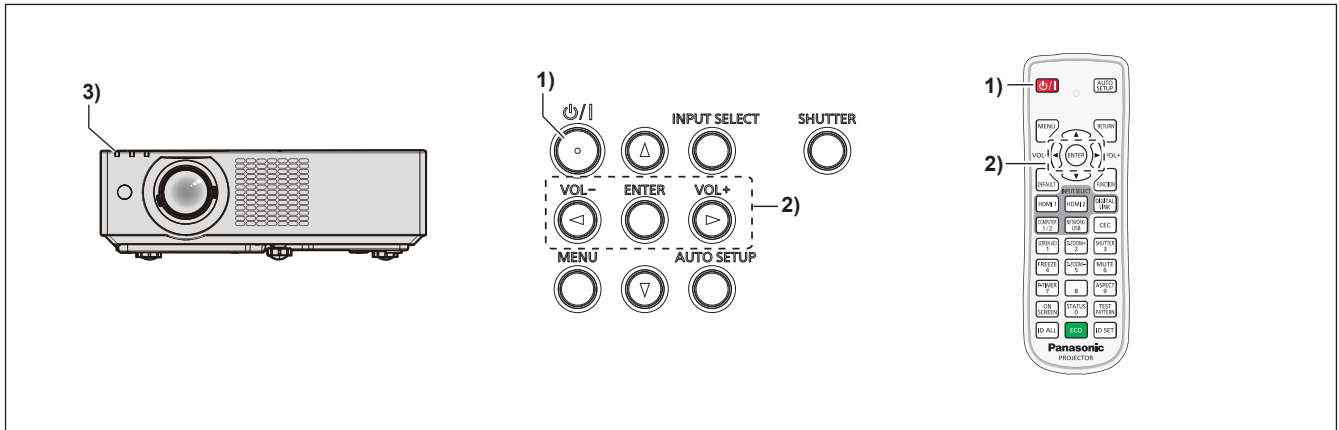

- 1) **Press the power <power icon> button.**
 - The [POWER OFF] confirmation screen is displayed.
- 2) **Press <left><right> to select [OK], and press the <ENTER> button.**
(Or press the power <power icon> button again.)
 - Projection of the image will stop, and the power indicator <ON(G)/STANDBY(R)> on the projector lights orange. (The fans keep running.)
- 3) **Wait until the power indicator <ON(G)/STANDBY(R)> on the projector lights or blinks red.**
 - The projector enters standby mode when the power indicator <ON(G)/STANDBY(R)> lights or blinks red.
- 4) **Disconnect the plug of the power cord from the outlet.**

Note

- For approximately five seconds after the projector is turned off, the indicator does not light up even if the power is turned on.
- **Even if the power is turned off by pressing the power <power icon> button, the projector consumes power if the power plug is connected to the outlet.**
 When the [PROJECTOR SETUP] menu → [ECO MANAGEMENT] → [STANDBY MODE] is set to [ECO], use of some functions is restricted, but the power consumption during standby can be conserved.
- The projector supports direct power off function. You can cut off the power supply during projection by disconnecting the power cord from the outlet or by switching off the circuit breaker in case of ceiling mount. However, the settings or adjustments performed right before the power is turned off may not be reflected.

Projecting

Check the connections of the external devices (➔ page 40) and connection of the power cord (➔ page 45) and then power on the projector (➔ page 47) to start projecting. Select the image and adjust the state of the image.

Selecting the image input for projection

Switch the image input for projection. Method to switch the input is as follows.

- Press the input selection buttons on the remote control and directly specify the input to project.
- Press the <INPUT SELECT> button on the control panel to display the input guide and select the input to be projected.

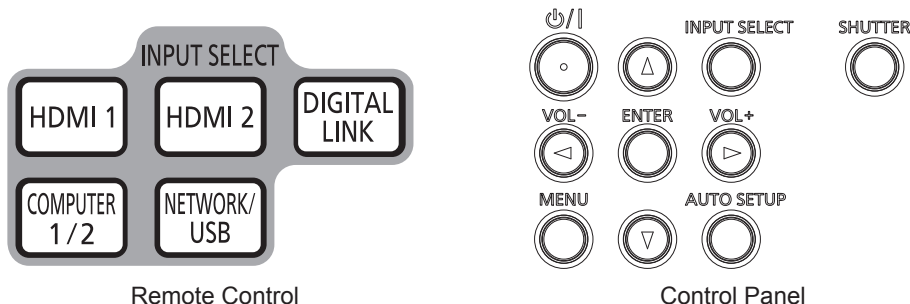

Switching the input directly with the remote control

The input for projection can be switched by directly specifying it with the input selection button on the remote control.

- 1) Press the input selection buttons (<HDMI 1>, <HDMI 2>, <DIGITAL LINK>, <COMPUTER 1/2>, <NETWORK/USB>).

Remote control buttons	Input	Usage
<HDMI 1>	HDMI 1	Switches the input to HDMI 1. Displays the image signals input via the <HDMI IN 1> terminal.
<HDMI 2>	HDMI 2	Switches the input to HDMI 2. Displays the image signals input via the <HDMI IN 2> terminal.
<DIGITAL LINK> ^{*1}	DIGITAL LINK	Switches the input to DIGITAL LINK. Displays the image signals input via the <DIGITAL LINK/LAN> terminal.
<COMPUTER 1/2>	COMPUTER 1	Switches the input to COMPUTER 1 or COMPUTER 2. Displays the image signals input via the <COMPUTER 1 IN> terminal or the <COMPUTER 2 IN> terminal. If one input has been selected already, the input will be switched every time the button is pressed.
	COMPUTER 2	
<NETWORK/USB>	MEMORY VIEWER	Switches the input to MEMORY VIEWER or NETWORK. If one input has been selected already, the input will be switched every time the button is pressed. <ul style="list-style-type: none"> • MEMORY VIEWER: Displays the still images in the USB memory with the Memory Viewer function. (➔ page 116) • NETWORK: Displays images transmitted from a terminal over wireless LAN / wired LAN by using the image transfer application software. (➔ page 118)
	NETWORK	

*1 Not available for the remote control supplied with PT-VMZ51S and PT-VMZ41.

- When switching inputs, the input guide for detailed or simple display is temporarily displayed. For the input guide, refer to “Switching the input with the control panel” (➔ page 54) or the [DISPLAY OPTION] menu → [ON-SCREEN DISPLAY] → [INPUT GUIDE].

Attention

- Images may not be projected properly depending on the external device, or the Blu-ray disc or DVD disc, to be played back. Set the following menu items according to the input signal.
 - [PICTURE] menu → [RGB/YC_BC_R]
 - [PICTURE] menu → [RGB/YF_BP_R]
 - [PICTURE] menu → [RGB-SYSTEM]

- Confirm the aspect ratio of the projection screen and the image, and switch to an optimum aspect ratio from the [POSITION] menu → [ASPECT].

Note

- If NETWORK input is selected, the image from a computer (including iPad / iPhone / iPod touch and Android device) can be transferred via wireless LAN/wired LAN to the projector by using the Panasonic image transfer application software.
For details about the image transfer application software "Presenter Light" and "Wireless Projector", refer to the website (<https://panasonic.net/cns/projector/>).
- When the optional DIGITAL LINK output supported device (Model No.: ET-YFB100G, ET-YFB200G) is connected to the <DIGITAL LINK/ LAN> terminal, the input on the DIGITAL LINK output supported device changes each time the <DIGITAL LINK> button is pressed. The input can also be changed using the RS-232C control command.
For twisted-pair-cable transmitters of other manufacturers, switch the input on the projector to DIGITAL LINK, and then switch the input on the twisted-pair-cable transmitter.
For details of the RS-232C operation command, refer to "<SERIAL IN> terminal" (▶ page 160).
- If one of COMPUTER 1 / COMPUTER 2 / HDMI 1 / HDMI 2 input is selected and no signal is input, the following screen is displayed. Check the output setting of your computer.

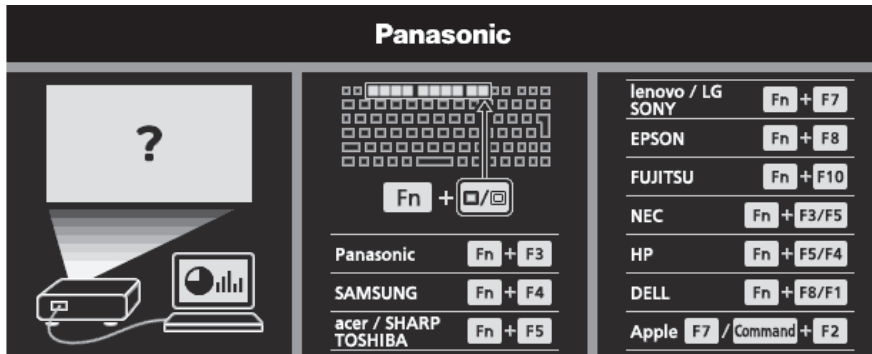

Switching the input with the control panel

The input can be switched with the <INPUT SELECT> button on the control panel
After pressing the <INPUT SELECT> button, the detailed or simple input guide is displayed.

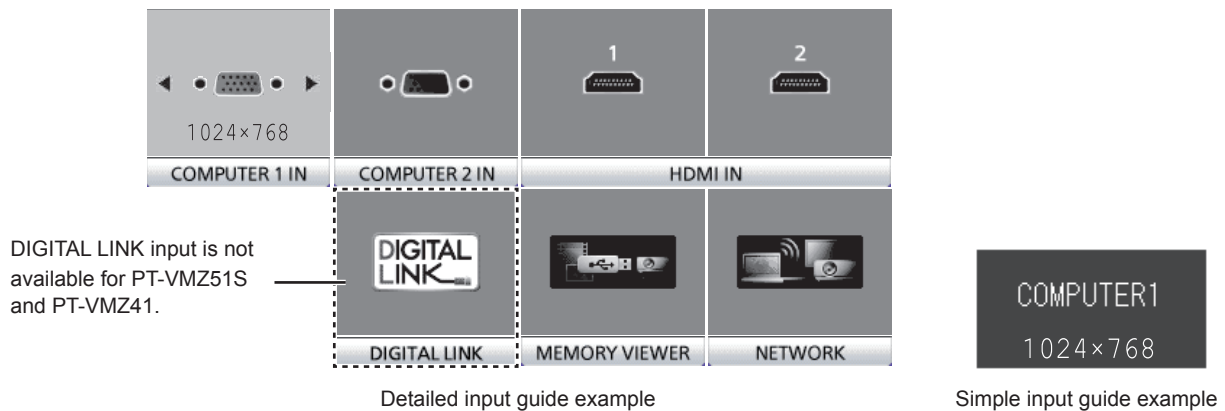

1) Press the <INPUT SELECT> button on the control panel.

- The input guide is displayed.

2) Press the <INPUT SELECT> button again.

- The input is switched every time you press the <INPUT SELECT> button.
- When the detailed input guide is displayed, you can select the input with the ▲▼◀▶ buttons on the control panel or on the remote control.

Note

- You can switch the detailed/simple input guide by setting the [DISPLAY OPTION] menu → [ON-SCREEN DISPLAY] → [INPUT GUIDE].
- When the [DISPLAY OPTION] menu → [ON-SCREEN DISPLAY] → [INPUT GUIDE] is set to [OFF], the input guide is not displayed.

Adjusting the focus, zoom, and lens shift

Adjust the focus, zoom, and lens shift if the image projected to the screen or its position is shifted even if the projector and the screen are set up in the correct positions.

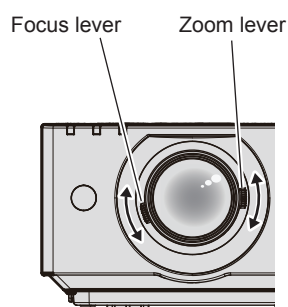

Fig. 1

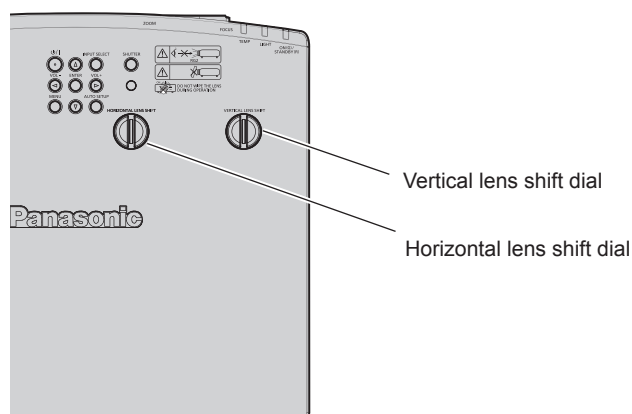

Fig. 2

1) Adjust the zoom and the focus. (Fig. 1)

- Operate the focus lever to adjust the focus.
- Operate the zoom lever to adjust the projected image size to fit the screen.

2) Adjust the lens shift. (Fig. 2)

- Turn the horizontal and vertical lens shift dial and adjust the horizontal and vertical projection position on the screen. For details, refer to "About lens shift adjustment range" (➔ page 56).

Note

- It is recommended that the images are projected continuously for at least 30 minutes before the focus is adjusted.
- When the focus is adjusted, the projection screen size also changes slightly. Depending on the image projection situation, repeat Steps 1) to 2) to adjust to the best projection condition.
- Adjust from the [POSITION] menu → [SCREEN ADJUSTMENT] when the projected image is distorted.

Adjusting adjustable feet

Install the projector on a flat surface so that the front of the projector is parallel to the screen surface and the projection screen is rectangular.

If the screen tilts upward or downward, extend the front adjustable foot and rear adjustable feet to adjust the projection screen to be rectangular. If the screen tilts in the horizontal direction, adjust the rear adjustable feet to make the screen level. Adjustable feet can be extended by turning them as shown in the figure. Turning them in the opposite direction will return them to the original position.

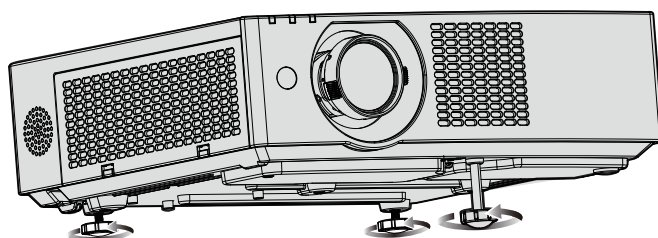

Maximum adjustable range

Front adjustable foot : 37 mm (1-15/32")

Rear adjustable feet : 7.5 mm (9/32") each

Attention

- Be careful not to block the intake/exhaust vents with your hands or any objects when adjusting the adjustable feet while the light source is on. (➔ page 29)

About lens shift adjustment range

The projector supports lens shift in horizontal and vertical direction. The following figure shows the lens shift adjustable range in horizontal and vertical direction with reference to the standard projection position. Following illustration indicates the lens shift range when the projector is installed on desk/floor.

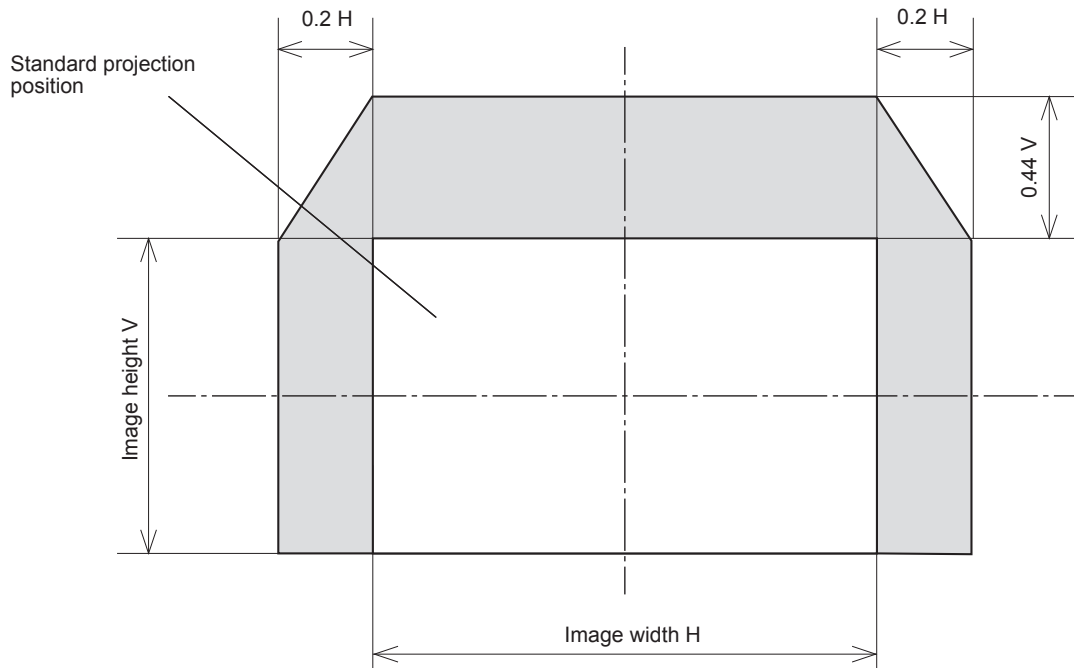

Note

- The standard projection position indicates the projection screen position in the state without lens shift adjustment.

Operating with the remote control

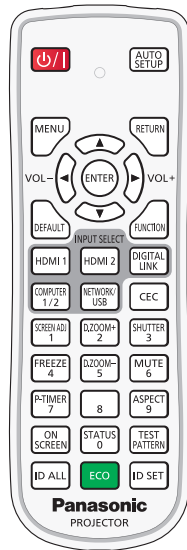

For PT-VMZ71, PT-VMZ61, PT-VMZ51,
PT-VMW61, PT-VMW51

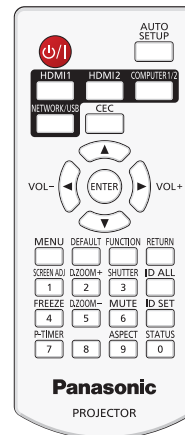

For PT-VMZ51S, PT-VMZ41

Using the shutter function

If the projector is not used for a certain period of time during the meeting intermission, for example, it is possible to turn off the image and audio temporarily.

button

- 1) **Press the <SHUTTER> button.**
 - The image and audio disappear.
 - This operation can be also performed by pressing the <SHUTTER> button on the control panel.
- 2) **Press the <SHUTTER> button again.**
 - The image and audio reappear.

Note

- The power indicator <ON (G)/STANDBY (R)> will blink (0.75 seconds (light) → 0.75 seconds (off)) green while the shutter function is in use (shutter: closed).
- Even when the shutter function is in use (shutter: closed), the power <P> button and input select (<HDMI 1>, <HDMI 2>, <DIGITAL LINK>, <COMPUTER 1/2>, <NETWORK / USB>) buttons can be operated.
- The light source may be lit dimly due to warm up when the shutter function is used in the operating environment temperature of around 0 °C (32 °F).

Using the mute function

This button allows you to turn off the audio output temporarily.

button

- 1) **Press the <MUTE> button.**
 - The audio turns off.
- 2) **Press the <MUTE> button again.**
 - The audio turns on.

Adjusting the volume

You can control the volume of the built-in speaker and audio output.



1) Press the <VOL -> button / <VOL +> button.

<VOL +>	Increases the volume.
<VOL ->	Decreases the volume.

Note

- You can also operate with the <VOL -> button and <VOL +> button on the control panel.

Using the freeze function

You can freeze the projected image and mute the sound temporarily, regardless of the playback status of the external device.



- 1) Press the <FREEZE> button.
 - The image is paused and the audio is muted.
- 2) Press the <FREEZE> button again.
 - The image resumes and the audio is output.

Note

- [FREEZE] is displayed at the lower left of the projection screen in freeze status.
- When freezing of the moving image is canceled, the image may disappear or be disrupted temporarily.

Using the on-screen display function

(Not available for the remote control supplied with PT-VMZ51S and PT-VMZ41)
 Turn off the on-screen display function (no display) when you do not wish the viewers to see the on-screen display, such as the menu or the input terminal name.



- 1) Press the <ON SCREEN> button.
 - The on-screen display disappears.
- 2) Press the <ON SCREEN> button again.
 - The on-screen display appears.

Note

- If you press the <MENU> button on the control panel for at least three seconds while the on-screen display is off (hidden), the on-screen display is turned on.

Using the auto setup function

The dot clock, clock phase and image position can be adjusted automatically when the analog RGB still image signal is input. (Analog RGB signal is a signal structured with dots just like the computer signal.)
 It is recommended to input an image with bright white borders at the edges and high-contrast black and white characters when the automatic adjustment is being performed.
 Avoid using images that include halftones or gradation, such as photographs and computer graphics.



- 1) Press the <AUTO SETUP> button.

Note

- You can also use this function with the <AUTO SETUP> button on the control panel.
- The clock phase may shift even if the automatic adjustment is performed. In such a case, adjust the [POSITION] menu → [CLOCK PHASE]. (➔ page 78)
- When the input signal is a blurred-edge image or a dark image, it may not be able to be adjusted correctly even if the automatic adjustment is performed. In this case, adjust the following settings.
 - [POSITION] menu → [DOT CLOCK] (➔ page 78)
 - [POSITION] menu → [CLOCK PHASE] (➔ page 78)
 - [POSITION] menu → [SHIFT] (➔ page 77)
- Automatic adjustment may not be performed depending on the computer model and input signal.
- Images may be disrupted for a few seconds during automatic adjustment, but it is not a malfunction.
- Automatic adjustment can be canceled by pressing any button on the remote control during the automatic adjustment operation.
- If the automatic setup function is used while moving images are being input, the adjustment may not be performed properly even for a signal that can use automatic setup.

Using the screen adjustment function

You can correct various types of distortion in a projected image. Unique image processing technology enables projection of a square image on a special screen shape. Also, the projection distance can be extended with the Digital Zoom Extender function if the projection distance exceeds the optical zoom range of the projector.



- 1) Press the <SCREEN ADJ> button.
 - The [SCREEN ADJUSTMENT] screen is displayed.
- 2) Press ▲▼ to switch the item.

[DIGITAL ZOOM EXTENDER]	Sets [DIGITAL ZOOM EXTENDER] to extend the projection distance when the projection distance exceeds the optical zoom range.
[KEYSTONE]	Adjusts when the trapezoid of the projected image is distorted.
[CORNER CORRECTION]	Adjusts when the four corners of the projected image are distorted.
[CURVED CORRECTION]	Adjusts any curved distortion in the projected image.
[6POINT CORRECTION]	Corrects the distortion that occurs when projecting on a horizontal corner surface, such as a wall corner or a square pillar.

- Press ◀▶ to switch the item if [DIGITAL ZOOM EXTENDER] is selected.
 - Proceed to Step 3) if anything other than [DIGITAL ZOOM EXTENDER] is selected.
- 3) Press <ENTER> button.
 - The [KEYSTONE] screen, [CORNER CORRECTION] screen, [CURVED CORRECTION] screen or the [6POINT CORRECTION] screen is displayed.

Note

- For more details, refer to the [POSITION] menu → [SCREEN ADJUSTMENT]. (➔ page 74)

Using the digital zoom function

(Only for computer signals input)
 You can enlarge images. You can also change the location of the images to be enlarged.

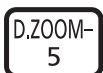
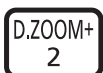

buttons

- 1) Press the <D.ZOOM -> button/<D.ZOOM +> button.
 - The moving screen is displayed when executing the remote control operation, and the [DIGITAL ZOOM] individual adjustment screen is not displayed.

- The [DIGITAL ZOOM] individual adjustment screen is displayed when executing the menu operation. For details, refer to [DISPLAY OPTION] menu → [OTHER FUNCTIONS] → [DIGITAL ZOOM]. (➔ page 87)

2) Press the following buttons to move the location of the image or adjust the magnification.

- For PT-VMZ71, PT-VMZ61, PT-VMZ51, PT-VMW61, PT-VMW51
The digital zoom function is canceled if the <D.ZOOM -> button/<D.ZOOM +> button is pressed for three seconds or more.

Operation menu/Buttons	Operation	Adjustment
<p>Moving screen</p> <p>Remote control operation button</p>	Press the ▲ button.	Moves the image to the bottom.
	Press the ▼ button.	Moves the image to the top.
	Press the ◀ button.	Moves the image to the right.
	Press the ▶ button.	Moves the image to the left.
	Press the <MENU> button.	Moves the image to the upper left.
	Press the <RETURN> button.	Moves the image to the upper right.
	Press the <ENTER> button.	Moves the image to the center.
	Press the <DEFAULT> button.	Moves the image to the lower left.
	Press the <FUNCTION> button.	Moves the image to the lower right.
	Press the <D.ZOOM +> button.	Increases magnification.
	Press the <D.ZOOM -> button.	Decreases magnification.

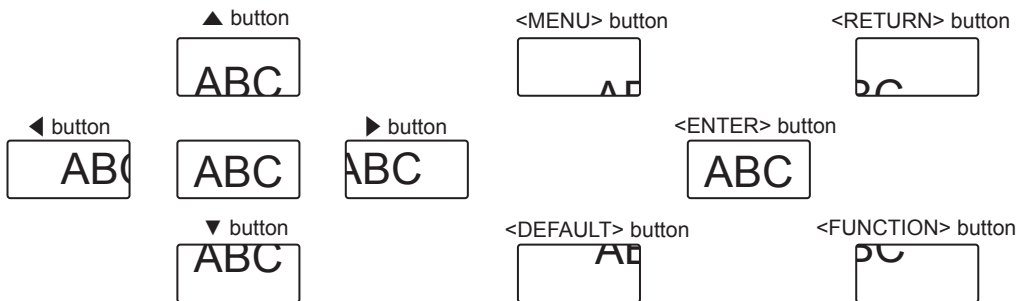

Fig. 1 Screen display position after the button operation

- For PT-VMZ51S, PT-VMZ41

The digital zoom function is canceled if the <D.ZOOM -> button/<D.ZOOM +> button is pressed for three seconds or more or if the <MENU> button is pressed.

Operation menu/Buttons	Operation	Adjustment
<p>Moving screen</p> <p>Remote control operation button</p>	Press the ▲ button.	Moves the image to the bottom.
	Press the ▼ button.	Moves the image to the top.
	Press the ◀ button.	Moves the image to the right.
	Press the ▶ button.	Moves the image to the left.
	Press the <D.ZOOM +> button.	Increases magnification.
	Press the <D.ZOOM -> button.	Decreases magnification.

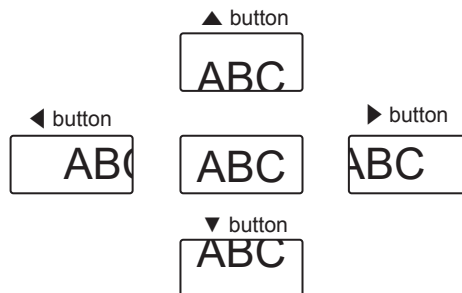

Fig. 2 Screen display position after the button operation

Note

- The magnification is not displayed in the moving screen.
- The digital zoom function is canceled if the input signal changes during a digital zoom.
- During a digital zoom, the freeze function is disabled.
- The digital zoom function may not work properly for some computer signals.

Switching the image aspect ratio

Switch the image aspect ratio according to the input.



button

1) Press the <ASPECT> button.

- The setting will change each time you press the button.

Note

- Refer to the [POSITION] menu → [ASPECT] (➔ page 79) for details.

Using the presentation timer function

The presentation timer can be operated.

The presentation can be performed while confirming the elapsed time or remaining time against the specified time.



button

1) Press the <P-TIMER> button.

- The count is started.

2) Press the <P-TIMER> button again.

- The count is stopped.

Note

- The elapsed time or the remaining time is displayed at the lower right of the projected image when using the presentation timer function.
- The count will be resumed from interruption when the <P-TIMER> button is pressed.
- The presentation timer function will be terminated by pressing the <P-TIMER> button for over three seconds.
- For details about the setting of the presentation timer function, refer to the [DISPLAY OPTION] menu → [P-TIMER]. (➔ page 85)

Using the FUNCTION button

Some frequently used menu items can be assigned to the <FUNCTION> button on the remote control so that it can be used as an shortcut button.



button

1) Press the <FUNCTION> button.

Assigning functions to the <FUNCTION> button

1) Press the <MENU> button to display the menu items (main menu, sub menu, or details menu) to be assigned.

- Refer to "Navigating through the menu" (➔ page 65) for the operation of the menu.

2) Press and hold the <FUNCTION> button for three seconds or more.

Note

- After the setting, the assigned menu items will be displayed as [ASSIGNED FUNCTION] in the operation guide under the menu.
- To cancel the function assignment, use the [PROJECTOR SETUP] menu → [FUNCTION BUTTON]. (➔ page 94)

Displaying internal test pattern

(Not available for the remote control supplied with PT-VMZ51S and PT-VMZ41)

To confirm the status of the projector, six types of internal test patterns can be displayed. To display test patterns, perform the following steps.



- 1) Press the <TEST PATTERN> button.
- 2) Press ◀▶ to select the test pattern.

Note

- Setting is also available from the [PROJECTOR SETUP] menu → [TEST PATTERN]. (➔ page 96)
- Settings of position, size, and other factors will not be reflected in test patterns. Make sure to display the input signal before performing various adjustments.

Using the status function

Display the status of the projector.



- 1) Press the <STATUS> button.
 - The [STATUS] screen is displayed.

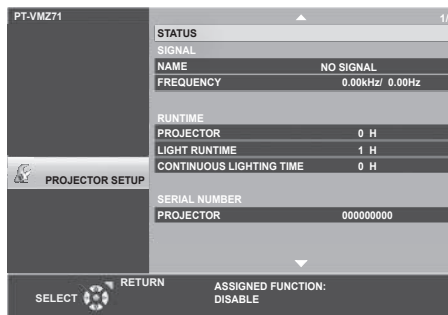

Note

- The projector status can also be displayed using the menu operation. Refer to the [PROJECTOR SETUP] menu → [STATUS] (➔ page 89) for details.

Using the ECO management function

(Not available for the remote control supplied with PT-VMZ51S and PT-VMZ41)

Display the setting screen relating to ECO management.



- 1) Press the <ECO> button.

Note

- Refer to the [PROJECTOR SETUP] menu → [ECO MANAGEMENT] (➔ page 90) for details.

Using the HDMI-CEC function

Display the HDMI-CEC operation screen.



button

1) Press the <CEC> button.

- The HDMI-CEC operation screen is displayed.

Note

- Refer to [PROJECTOR SETUP] menu → [HDMI CEC] (➔ page 97) for details.

Setting the ID number on the remote control

When you use the multiple projectors together, you can operate all the projectors simultaneously or each projector individually using a single remote control, if a unique ID number is assigned to each projector.

After setting the ID number of the projector, set the same ID number to the remote control.

The factory default ID number of the projector is set to [ALL]. When using a single projector, press the <ID ALL> button on the remote control. Also, you can control a projector by pressing the <ID ALL> button on the remote control even if you do not know the projector ID.



button button

1) Press the <ID SET> button on the remote control.

2) Within five seconds, press and set the one-digit or two-digit ID number set on the projector body using the number (<0> - <9>) buttons.

- If you press the <ID ALL> button, you can control the projectors regardless of the ID number setting of the projector.

Attention

- Since the ID number of the remote control can be set without the projector, do not press the <ID SET> button on the remote control carelessly. If the <ID SET> button is pressed and no number (<0> - <9>) buttons are pressed within five seconds, the ID number returns to its original value before the <ID SET> button was pressed.
- The ID number set on the remote control will be stored unless it is set again. However, it will be erased if the remote control is left with dead batteries. Set the same ID number again when the batteries are replaced.

Note

- When the ID number of the remote control is set to [0], the projectors can be controlled regardless of the ID number setting on the projector, same as when set to [ALL].
- Set the ID number of the projector from the [PROJECTOR SETUP] menu → [PROJECTOR ID]. (➔ page 89)

Chapter 4 Settings

This chapter describes the settings and adjustments you can make using the on-screen menu.

On-screen menu

The on-screen menu (menu screen) is used to perform various settings and adjustments of the projector.

Navigating through the menu

Operating procedure



- 1) Press the <MENU> button on the remote control or the control panel.
 - The main menu screen appears.

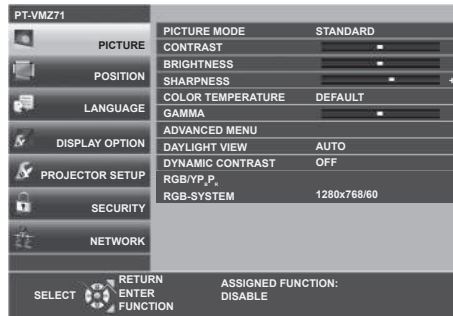

- 2) Press ▲▼ to select an item from the main menu.
 - The selected item is highlighted in yellow.

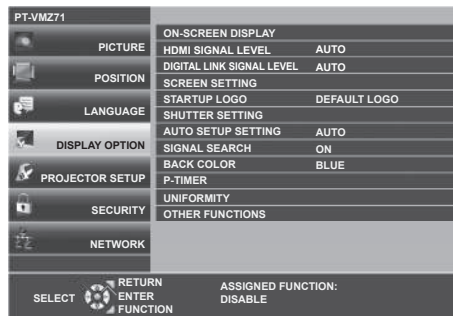

- 3) Press the <ENTER> button.
 - You can operate the sub-menus of the selected main menu.

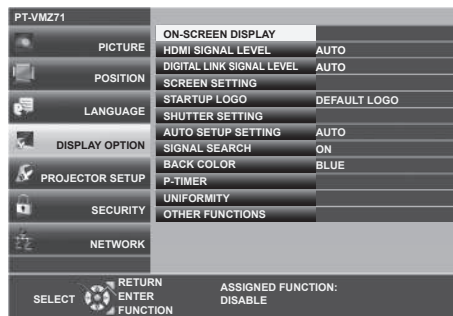

- 4) Press ▲▼ to select the desired sub-menu item, press ◀▶ or the <ENTER> button to switch or adjust settings.
 - Depending on the item, each time you press the ◀▶ button, items are switched in order as shown below.

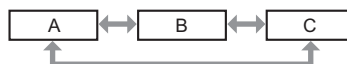

- Depending on the item, each time you press the ◀▶ button, the individual adjustment screen with a bar scale is displayed as shown below.



Note

- Pressing the <MENU> button while the menu screen is displayed will return to the previous menu. You can operate in the same way by pressing the <RETURN> button.
- Some items may not be adjusted or used depending on the selected signals or input signals to the projector. The menu items that cannot be adjusted or used are shown in gray characters, and they cannot be selected.
- Some items can be adjusted even if signals are not input.
- Individual adjustment screen disappears automatically if no operation is performed within approximately five seconds.
- For menu items, refer to “Main menu” (➔ page 66) and “Sub menu” (➔ page 67).

Resetting adjustment values to the factory default

If the <DEFAULT> button on the remote control is pressed, the values adjusted in the menu items are restored to the factory default settings.



button

- 1) Press the <DEFAULT> button on the remote control.

Note

- You cannot reset all the settings to the factory default at a time.
- To reset all the settings adjusted in the sub-menu item to the factory default at a time, execute the [PROJECTOR SETUP] menu → [INITIALIZE ALL].
- Some items cannot be reset by pressing the <DEFAULT> button on the remote control. Adjust these items individually.

Main menu

The main menu consists of the following seven menu items.

When a main menu item is selected, the cursor moves to its sub menu.

	Main-menu item	Page
	[PICTURE]	69
	[POSITION]	74
	[LANGUAGE]	81
	[DISPLAY OPTION]	82
	[PROJECTOR SETUP]	89
	[SECURITY]	100
	[NETWORK]	103

Sub menu

You can set and adjust the items in each submenu.

[PICTURE]

Sub-menu item	Factory default	Page
[PICTURE MODE]	[STANDARD]	69
[CONTRAST]	[0]	69
[BRIGHTNESS]	[0]	69
[COLOR]	[0]*1	70
[TINT]	[0]	70
[SHARPNESS]	[9]	70
[COLOR TEMPERATURE]	[DEFAULT]	70
[GAMMA]	[0]	70
[ADVANCED MENU]	—	71
[DAYLIGHT VIEW]	[AUTO]	71
[DIGITAL CINEMA REALITY]	[ON]	72
[DYNAMIC CONTRAST]	[OFF]	72
[RGB/YP _B P _R] / [RGB/YC _B C _R]	[AUTO]	73
[RGB-SYSTEM]	[1280x768/60]*1	73

*1 It depends on the input signal.

[POSITION]

Sub-menu item	Factory default	Page
[REALTIME KEYSTONE]	[ON]	74
[SCREEN ADJUSTMENT]	—	74
[SHIFT]	—	77
[DOT CLOCK]	[0]	78
[CLOCK PHASE]	[0]	78
[OVER SCAN]	[0]*1	79
[ASPECT]	[NORMAL]*1	79
[FRAME LOCK]	[ON]	79
[CLAMP POSITION]	[24]*1	80

*1 It depends on the input signal.

[LANGUAGE]

Details (➔ page 81)

[DISPLAY OPTION]

Sub-menu item	Factory default	Page
[ON-SCREEN DISPLAY]	-	82
[HDMI SIGNAL LEVEL]	[AUTO]	83
[DIGITAL LINK SIGNAL LEVEL]*1	[AUTO]	83
[SCREEN SETTING]	-	84
[STARTUP LOGO]	[DEFAULT LOGO]	84
[SHUTTER SETTING]	—	84
[AUTO SETUP SETTING]	[AUTO]	85
[SIGNAL SEARCH]	[ON]	85
[BACK COLOR]	[BLUE]	85
[P-TIMER]	-	85
[UNIFORMITY]	-	86
[OTHER FUNCTIONS]	-	87

*1 Not available for PT-VMZ51S and PT-VMZ41.

[PROJECTOR SETUP]

Sub-menu item	Factory default	Page
[STATUS]	-	89
[PROJECTOR ID]	[ALL]	89

Chapter 4 Settings - On-screen menu

Sub-menu item	Factory default	Page
[INITIAL START UP]	[LAST MEMORY]	89
[PROJECTION METHOD]	[AUTO]	90
[ECO MANAGEMENT]	-	90
[RS-232C]	-	90
[FUNCTION BUTTON]	-	94
[AUDIO SETTING]	-	94
[TEST PATTERN]	-	96
[FILTER COUNTER]	-	96
[HDMI CEC]	[ON]	97
[INITIALIZE ALL]	-	99

[SECURITY]

Sub-menu item	Factory Default	Page
[PASSWORD]	[OFF]	100
[PASSWORD CHANGE]	-	100
[TEXT DISPLAY]	[OFF]	101
[TEXT CHANGE]	-	101
[MENU LOCK]	[OFF]	101
[MENU LOCK PASSWORD]	-	101
[CONTROL DEVICE SETUP]	-	102

[NETWORK]

Sub-menu item	Factory default	Page
[ETHERNET TYPE] ^{*1}	[LAN]	103
[DIGITAL LINK] ^{*1}	-	103
[WIRED LAN]	-	105
[PROJECTOR NAME]	-	106
[NETWORK STATUS]	-	106
[ADMINISTRATOR ACCOUNT]	-	107
[NETWORK SECURITY]	-	110
[NETWORK CONTROL]	-	110
[PJLink]	-	111
[MEMORY VIEWER]	-	112
[INITIALIZE]	-	114

*1 Not available for PT-VMZ51S and PT-VMZ41.

Note

- Some items may not be adjusted or used for certain signal formats to be input to the projector.
The menu items that cannot be adjusted or used are shown in gray characters, and they cannot be selected.
- Sub-menu items and factory default settings differ depending on the selected input.

[PICTURE] menu

On the menu screen, select [PICTURE] from the main menu, and select an item from the submenu. Refer to “Navigating through the menu” (➔ page 65) for the operation of the menu screen.

[PICTURE MODE]

You can switch to the desired picture mode most suitable for the image source and the environment in which the projector is used.

- 1) Press ▲▼ to select [PICTURE MODE].
- 2) Press ◀▶ or the <ENTER> button.
 - The [PICTURE MODE] individual adjustment screen is displayed.
- 3) Press ◀▶ to switch the items.
 - The items will switch each time you press the button.

[STANDARD]	The picture becomes suitable for video images in general.
[DYNAMIC]	The picture becomes suitable for use in bright areas.
[DICOM SIM.]	The image becomes similar to that of DICOM Part 14 Grayscale Standard.
[WHITE BOARD]	The picture becomes suitable for projecting on a white board.
[CINEMA]*1	The picture becomes suitable for movie contents.
[NATURAL]*2	The picture becomes suitable for using in a relatively dark environment.

*1 Only for the video signals.

*2 Only for the computer signals.

Note

- DICOM is an abbreviation of “Digital Imaging and Communication in Medicine” and is a standard for medical imaging devices. Although the DICOM name is used, the projector is not a medical device, and should not be used for purposes such as diagnosis of display images.

[CONTRAST]

You can adjust the contrast of the colors.

- 1) Press ▲▼ to select [CONTRAST].
- 2) Press ◀▶ or the <ENTER> button.
 - The [CONTRAST] individual adjustment screen is displayed.
- 3) Press ◀▶ to adjust the level.

Operation	Adjustment	Adjustment range
Press the ▶ button.	The screen becomes brighter.	-32 ~ +32
Press the ◀ button.	The screen becomes darker.	

Attention

- Adjust [BRIGHTNESS] first when you need to adjust [BRIGHTNESS] and [CONTRAST].

[BRIGHTNESS]

You can adjust the dark (black) part of the projected image.

- 1) Press ▲▼ to select [BRIGHTNESS].
- 2) Press ◀▶ or the <ENTER> button.
 - The [BRIGHTNESS] individual adjustment screen is displayed.
- 3) Press ◀▶ to adjust the level.

Operation	Adjustment	Adjustment range
Press the ▶ button.	Increases the brightness of the dark (black) parts of the screen.	-32 ~ +32
Press the ◀ button.	Reduces the brightness of the dark (black) parts of the screen.	

[COLOR]

(Only for video signal input)

You can adjust the color saturation of the projected image.

- 1) Press ▲▼ to select [COLOR].
- 2) Press ◀▶ or the <ENTER> button.
 - The [COLOR] individual adjustment screen is displayed.
- 3) Press ◀▶ to adjust the level.

Operation	Adjustment	Adjustment range
Press the ▶ button.	Deepens colors.	-32 ~ +32
Press the ◀ button.	Weakens colors.	

[TINT]

(Only for video signal input)

You can adjust the skin tone in the projected image.

- 1) Press ▲▼ to select [TINT].
- 2) Press ◀▶ or the <ENTER> button.
 - The [TINT] individual adjustment screen is displayed.
- 3) Press ◀▶ to adjust the level.

Operation	Adjustment	Adjustment range
Press the ▶ button.	Adjusts skin tone toward greenish color.	-32 ~ +32
Press the ◀ button.	Adjusts skin tone toward reddish purple.	

[SHARPNESS]

You can adjust the sharpness of the projected image.

- 1) Press ▲▼ to select [SHARPNESS].
- 2) Press ◀▶ or the <ENTER> button.
 - The [SHARPNESS] individual adjustment screen is displayed.
- 3) Press ◀▶ to adjust the level.

Operation	Adjustment	Adjustment range
Press the ▶ button.	Contours become sharper.	0 ~ +15
Press the ◀ button.	Contours become softer.	

[COLOR TEMPERATURE]

You can switch the color temperature if the white areas of the projected image are bluish or reddish.

- 1) Press ▲▼ to select [COLOR TEMPERATURE].
- 2) Press ◀▶ or the <ENTER> button.
 - The [COLOR TEMPERATURE] individual adjustment screen is displayed.
- 3) Press ◀▶ to switch the item.
 - The items will switch each time you press the button.

[DEFAULT]	Factory default setting.
[HIGH]	Becomes a bluish image. Select this when the white areas of the projected image are reddish.
[LOW]	Becomes a reddish image. Select this when the white areas of the projected image are bluish.

[GAMMA]

You can adjust contrast balance.

- 1) Press ▲▼ to select [GAMMA].

- 2) Press ◀▶ or the <ENTER> button.
 - The [GAMMA] individual adjustment screen is displayed.
- 3) Press ◀▶ to adjust the level.

Operation	Adjustment	Adjustment range
Press the ▶ button.	The midtones become brighter.	-8 ~ +7
Press the ◀ button.	The midtones become darker.	

[ADVANCED MENU]

You can perform more advanced image adjustment.

- 1) Press ▲▼ to select [ADVANCED MENU].
- 2) Press the <ENTER> button.
 - The [ADVANCED MENU] screen is displayed.
- 3) Press ▲▼ to select one item among [CONTRAST R] ~ [BRIGHTNESS B].
- 4) Press ◀▶ or the <ENTER> button.
 - The individual adjustment screen of items are displayed.
- 5) Press ◀▶ to adjust the value.

Items	Operation	Adjustment	Adjustment range
[CONTRAST R]	Press the ▶ button.	Emphasizes red in highlight areas.	-32 ~ +32
	Press the ◀ button.	Deemphasizes red in highlight areas.	
[CONTRAST G]	Press the ▶ button.	Emphasizes green in highlight areas.	-32 ~ +32
	Press the ◀ button.	Deemphasizes green in highlight areas.	
[CONTRAST B]	Press the ▶ button.	Emphasizes blue in highlight areas.	-32 ~ +32
	Press the ◀ button.	Deemphasizes blue in highlight areas.	
[BRIGHTNESS R]	Press the ▶ button.	Emphasizes red in shadow areas.	-32 ~ +32
	Press the ◀ button.	Deemphasizes red in shadow areas.	
[BRIGHTNESS G]	Press the ▶ button.	Emphasizes green in shadow areas.	-32 ~ +32
	Press the ◀ button.	Deemphasizes green in shadow areas.	
[BRIGHTNESS B]	Press the ▶ button.	Emphasizes blue in shadow areas.	-32 ~ +32
	Press the ◀ button.	Deemphasizes blue in shadow areas.	

[DAYLIGHT VIEW]

You can correct the image to the optimal vividness even if it is projected under a bright light.

- 1) Press ▲▼ to select [DAYLIGHT VIEW].
- 2) Press ◀▶ or the <ENTER> button.
 - The [DAYLIGHT VIEW] individual adjustment screen is displayed.
- 3) Press ◀▶ to switch the item.
 - The items will switch each time you press the button.

[OFF]	No correction.
[1]	Corrects the image to weaken vividness.
[2]	Corrects the image to medium vividness.
[3]	Corrects the image to high vividness.
[AUTO]	Detects the brightness of the installed environment by the luminance sensor, and automatically corrects the vividness of the image.

Note

- [DAYLIGHT VIEW] cannot be set to [AUTO] when the [PROJECTOR SETUP] menu → [PROJECTION METHOD] is set to [REAR/DESK] or [REAR/CEILING].
- The luminance may not be detected correctly when an object is placed on top of the projector, blocking the luminance sensor. In such a case, this function may not operate properly even if it is set to [AUTO].

[DIGITAL CINEMA REALITY]

When inputting the following signals, it performs cinema processing to improve the vertical resolution and the image quality.

480/60i, 576/50i, 1080/60i, 1080/50i signals

- 1) Press ▲▼ to select [DIGITAL CINEMA REALITY].
- 2) Press ◀▶ or the <ENTER> button.
 - The [DIGITAL CINEMA REALITY] individual adjustment screen is displayed.
- 3) Press ◀▶ to switch the item.
 - The items will switch each time you press the button.

[OFF]	Performs no cinema processing.
[ON]	Performs cinema processing.

[DYNAMIC CONTRAST]

Light adjustment of the light source and signal compensation are performed automatically according to the image to make the contrast optimum for the image.

- 1) Press ▲▼ to select [DYNAMIC CONTRAST].
- 2) Press ◀▶ or the <ENTER> button.
 - The [DYNAMIC CONTRAST] individual adjustment screen is displayed.
- 3) Press ◀▶ to switch the item.
 - The items will switch each time you press the button.

[OFF]	Disables the dynamic contrast function.
[1]	Adjusts the light source and compensates signals to a small extent.
[2]	Adjusts the light source and compensates signals to a large extent.
[USER]	The light source can be set to turn off when the brightness level of the input image signal falls below a certain value. Refer to "Setting the light off condition of the light source" (➔ page 72) for details.

Note

- [DYNAMIC CONTRAST] can be adjusted only when there is a signal input. Its settings are effective only when no on-screen display such as menu screen (OSD) or input guide, a test pattern, or a warning message is displayed.

Setting the light off condition of the light source

- 1) Press ▲▼ to select [DYNAMIC CONTRAST].
- 2) Press ◀▶ or the <ENTER> button.
 - The [DYNAMIC CONTRAST] individual adjustment screen is displayed.
- 3) Press ◀▶ to select [USER].
- 4) Press the <ENTER> button.
 - The [DYNAMIC CONTRAST] screen is displayed.
- 5) Press ▲▼ to select the item to set.
 - The items in the detailed setting will switch each time you press ◀▶.

Setting item		Details
[LIGHTS OUT TIMER] (Setting of the waiting time before turning off the light)	[DISABLE]	Does not turn off the light source.
	[0.5s] ~ [10.0s]	Turns off the light source when the brightness level of the image signal being input goes under the value set in [LIGHTS OUT SIGNAL LEVEL]. Select an item from [0.5s] - [4.0s], [5.0s], [7.0s], or [10.0s]. [0.5s] - [4.0s] can be selected in increments of 0.5.
[LIGHTS OUT SIGNAL LEVEL] (Setting of the brightness level of the signal to turn off the light)	[0%] ~ [5%]	Sets the level of the brightness of the image signal to turn off the light source with [LIGHTS OUT TIMER]. Can be set in increments of 1%. (Factory setting: 0%)

Note

- [LIGHTS OUT SIGNAL LEVEL] cannot be set when [LIGHTS OUT TIMER] is set to [DISABLE].
- When [LIGHTS OUT TIMER] is set to anything other than [DISABLE], the following are the conditions to turn the light source back on again from the state that the light source has turned off by this function.
 - When the brightness level of the image signal being input has exceeded the value set in [LIGHTS OUT SIGNAL LEVEL]
 - When the input signal is gone
 - When on-screen display such as menu screen (OSD) or input guide, a test pattern, or a warning message is displayed
- When the image of analog signal is projected, the image may be affected by the signal noise while the brightness level of the image signal is detected. In such case, it is determined that the signal has not fallen below even when the brightness level of the image falls below the value set in [LIGHTS OUT SIGNAL LEVEL].

[RGB/YC_BC_R] / [RGB/YP_BP_R]

The projector will automatically detect the input signal, but you can set the system format manually when an unstable signal is input. Set the system format matching the input signal.

- 1) Press ▲▼ to select [RGB/YC_BC_R] or [RGB/YP_BP_R].
- 2) Press ◀▶ or the <ENTER> button.
 - The [RGB/YC_BC_R] or [RGB/YP_BP_R] individual adjustment screen is displayed.
- 3) Press ◀▶ to switch the item.
 - The items will switch each time you press the button.
 - Normally it is set to [AUTO]. If it cannot project properly with [AUTO], set it to [RGB], [YC_BC_R] or [YP_BP_R] according to the input signal.

Terminal	System format	
<COMPUTER 1 IN> terminal / <COMPUTER 2 IN> terminal	480/60i, 576/50i, 480/60p, 576/50p	Select [AUTO], [RGB] or [YC _B C _R]
	Other video signals	Select [AUTO], [RGB] or [YP _B P _R]
<HDMI IN 1> terminal / <HDMI IN 2> terminal / <DIGITAL LINK/LAN> terminal	480/60i, 576/50i, 480/60p, 576/50p	Select [AUTO], [RGB] or [YC _B C _R]
	Other image signals	Select [AUTO], [RGB] or [YP _B P _R]

Note

- For details of the image signals that can be used with the projector, refer to “List of compatible signals” (➔ page 168).
- This may not operate properly for some connected external devices.

[RGB-SYSTEM]

(Only for analog RGB signal input)

The projector automatically detects the input signal, but the images may not be displayed properly depending on the input signal. In that case, select the item according to the input signal.

- 1) Press ▲▼ to select [RGB-SYSTEM].
- 2) Press the <ENTER> button.
 - The [RGB-SYSTEM] screen is displayed.
- 3) Press ▲▼ to select the signal and press the <ENTER> button.
 - The selectable items differ depending on the input signal.

Items	Resolution (dots)	Scanning frequency		Dot clock frequency (MHz)
		Horizontal (kHz)	Vertical (Hz)	
[1280x768/60]	1 280 x 768	47.7	60.0	80.1
[1366x768/60]	1 366 x 768	47.7	60.0	84.7
[1400x1050/60]	1 400 x 1 050	65.2	60.0	122.6
[1680x1050/60]	1 680 x 1 050	65.2	60.0	147.1
[1440x900/50]	1 440 x 900	46.3	50.0	87.4
[1600x900/50]	1 600 x 900	46.3	50.0	97.0
[1440x900/60]	1 440 x 900	55.9	60.0	106.5
[1600x900/60]	1 600 x 900	55.9	60.0	119.0
[1024x768/50]	1 024 x 768	39.6	50	51.9
[1280x1024/60]	1 280 x 1 024	64.0	60	108.0

Note

- It may not work properly for some connected external devices.

[POSITION] menu

On the menu screen, select [POSITION] from the main menu, and select an item from the submenu. Refer to “Navigating through the menu” (➔ page 65) for the operation of the menu screen.

Note

- When the optional DIGITAL LINK output supported device (Model No.: ET-YFB100G, ET-YFB200G) is connected to the <DIGITAL LINK/LAN> terminal, adjust the shift and aspect from the menu of DIGITAL LINK output supported device first.

[REALTIME KEYSTONE]

The projector can correct the vertical trapezoidal distortion automatically when the projector is installed tilted.

- Press ▲▼ to select [REALTIME KEYSTONE].
- Press ◀▶ or the <ENTER> button.
 - The [REALTIME KEYSTONE] individual adjustment screen is displayed.
- Press ◀▶ to switch the item.

[ON]	Enables the automatic realtime keystone correction.
[OFF]	Disables the automatic realtime keystone correction.

Note

- Depending on the installation situation, the trapezoidal distortion may not be able to fully corrected. In this case, perform the adjustment in the [POSITION] menu → [SCREEN ADJUSTMENT].
- [REALTIME KEYSTONE] cannot be set in following cases.
 - When the [PROJECTOR SETUP] menu → [PROJECTION METHOD] is set to [FRONT/CEILING] or [REAR/CEILING]
 - When the [PROJECTOR SETUP] menu → [PROJECTION METHOD] → [AUTO], and the actual installation status is ceiling mount

[SCREEN ADJUSTMENT]

You can correct various types of distortion in a projected image. Unique image processing technology enables projection of a square image on a special screen shape.

Also, the projection distance can be extended with the Digital Zoom Extender function if the projection distance exceeds the optical zoom range of the projector.

- Press ▲▼ to select [SCREEN ADJUSTMENT].
- Press the <ENTER> button.
 - The [SCREEN ADJUSTMENT] screen is displayed.
- Press ▲▼ to select one item to adjust.

[DIGITAL ZOOM EXTENDER]	Sets [DIGITAL ZOOM EXTENDER] to extend the projection distance when the projection distance exceeds the optical zoom range.
[KEYSTONE]	Adjusts when the projected image is distorted as trapezoid.
[CORNER CORRECTION]	Adjusts when the four corners of the projected image are distorted.
[CURVED CORRECTION]	Adjusts when the projected image is curved distortion.
[6POINT CORRECTION]	Corrects the distortion that occurs when projecting on a horizontal corner surface, such as a wall corner or a square pillar.

Note

- [KEYSTONE], [CURVED CORRECTION] and [6POINT CORRECTION] cannot be adjusted if [DIGITAL ZOOM EXTENDER] is set to anything other than [OFF].
- Only one item of [KEYSTONE], [CORNER CORRECTION], [CURVED CORRECTION] and [6POINT CORRECTION] can be enabled. If you perform the setting of [KEYSTONE], [CORNER CORRECTION], [CURVED CORRECTION] or [6POINT CORRECTION] and then perform the setting of the other items, the value of the previous items will be reset.
- If you perform the setting of [KEYSTONE], [CURVED CORRECTION] or [6POINT CORRECTION] and then perform the setting of [DIGITAL ZOOM EXTENDER], the value of the previous items will be reset.
- If you perform the setting of [CORNER CORRECTION] and then perform the setting of [DIGITAL ZOOM EXTENDER], the value of the [CORNER CORRECTION] will be reset to the value of [DIGITAL ZOOM EXTENDER].
- [DIGITAL ZOOM EXTENDER] will automatically switch to [OFF] if [CORNER CORRECTION] adjustment is performed.

- The image quality will deteriorate as the correction amount of [SCREEN ADJUSTMENT] increases. Install the projector so that the correction amount is as small as possible.
- When adjustments are performed with [SCREEN ADJUSTMENT], the image size also changes.

Setting [DIGITAL ZOOM EXTENDER]

Sets [DIGITAL ZOOM EXTENDER] to extend the projection distance when the projection distance exceeds the optical zoom range.

- 1) Press ▲▼ to select [SCREEN ADJUSTMENT].
- 2) Press the <ENTER> button.
 - The [SCREEN ADJUSTMENT] screen is displayed.
- 3) Press ▲▼ to select [DIGITAL ZOOM EXTENDER].
- 4) Press ◀▶ to switch the item.
 - The items will switch each time you press the button.

[OFF]	Disables the [DIGITAL ZOOM EXTENDER] function.
[100%]	Displays the projected image which is not adjusted by the [DIGITAL ZOOM EXTENDER] function.
[95%]	Sets according to the projection distance that exceeds the optical zoom range of the projector. For details, refer to "Projected image and throw distance" (➔ page 36).
[90%]	
[85%]	
[80%]	

Note

- The [DIGITAL ZOOM EXTENDER] function is realized via corner correction and the resolution may decrease when using this function. It is not recommended to use this function when the projection distance is within the optical zoom range.

Setting [KEYSTONE]

- 1) Press ▲▼ to select [SCREEN ADJUSTMENT].
- 2) Press the <ENTER> button.
 - The [SCREEN ADJUSTMENT] screen is displayed.
- 3) Press ▲▼ to select [KEYSTONE].
- 4) Press the <ENTER> button.
 - The [KEYSTONE] individual adjustment screen is displayed.
- 5) Press ▲▼◀▶ to adjust the item.

Items	Operation	Adjustment
[H]	Press the ◀ button.	Left side will be smaller.
	Press the ▶ button.	Right side will be smaller.
[V]	Press the ▲ button.	Upper will be smaller.
	Press the ▼ button.	Lower will be smaller.

Note

- The image quality may degrade and it becomes difficult to focus as the amount of correction increases. When installing the projector, try to ensure that the amount of correction required is minimal.

Setting [CORNER CORRECTION]

- 1) Press ▲▼ to select [SCREEN ADJUSTMENT].
- 2) Press the <ENTER> button.
 - The [SCREEN ADJUSTMENT] screen is displayed.
- 3) Press ▲▼ to select [CORNER CORRECTION].
- 4) Press the <ENTER> button.
 - The [CORNER CORRECTION] screen is displayed.
- 5) Press ▲▼ to select the item to adjust. Then press the <ENTER> button.
 - The [CORNER CORRECTION] individual adjustment screen is displayed.
- 6) Press ▲▼◀▶ to adjust.

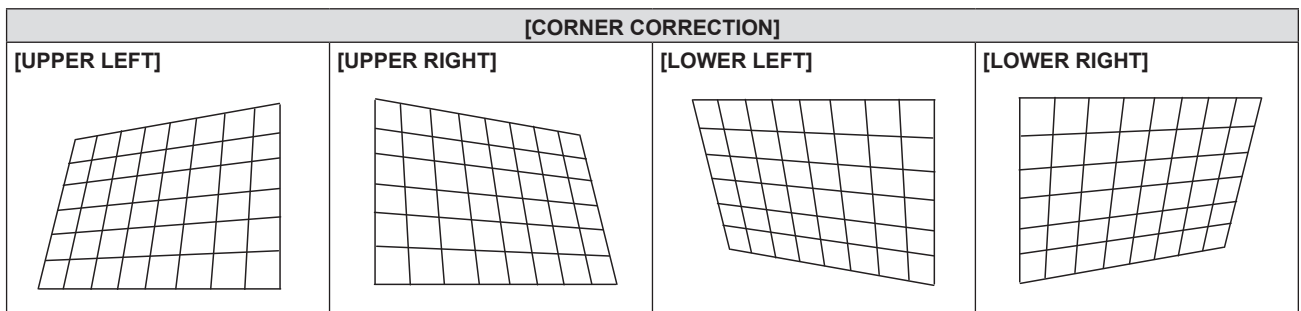

Note

- When the [CORNER CORRECTION] individual adjustment screen is displaying, the individual adjustment screen of the next corner can also be displayed by pressing the <ENTER> button.
- Depending on the correction amount, the image aspect ratio may change.

Setting [CURVED CORRECTION]

- 1) Press ▲▼ to select [SCREEN ADJUSTMENT].
- 2) Press the <ENTER> button.
 - The [SCREEN ADJUSTMENT] screen is displayed.
- 3) Press ▲▼ to select [CURVED CORRECTION].
- 4) Press the <ENTER> button.
 - The [CURVED CORRECTION] screen is displayed.
- 5) Press ▲▼ to select one item to adjust.

[KEYSTONE]	Adjusts when the trapezoid of the projected image is distorted.
[ARC]	Adjusts when the radian of the projected image is distorted.

- 6) Press the <ENTER> button.
 - The [KEYSTONE] or the [ARC] individual adjustment screen is displayed.

Adjusting [KEYSTONE]

- 1) Press ▲▼◀▶ to adjust.
 - For details, please refer to "Setting [KEYSTONE]" (➡ page 75)

Adjusting [ARC]

- 1) Press ▲▼◀▶ to adjust.

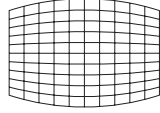
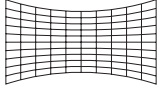
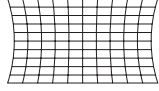
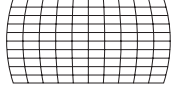
Items	Operation	Adjustment		
[H]	Press the ◀ button.	The top and the bottom of horizontal line will be bulge.		
	Press the ▶ button.	The top and the bottom of horizontal line will be dent.		
[V]	Press the ▲ button.	The left and the right of vertical line will be dent.		
	Press the ▼ button.	The left and the right of vertical line will be bulge.		

Note

- Pressing the <ENTER> button while the individual adjustment screen is displayed can switch to the individual adjustment screen of other items.

Setting [6POINT CORRECTION]

- 1) Press ▲▼ to select [SCREEN ADJUSTMENT].
- 2) Press the <ENTER> button.
 - The [SCREEN ADJUSTMENT] screen is displayed.
- 3) Press ▲▼ to select [6POINT CORRECTION].
- 4) Press the <ENTER> button.
 - The [6POINT CORRECTION] screen is displayed.
- 5) Press ▲▼ to select the item to adjust. Then press the <ENTER> button.
 - The [6POINT CORRECTION] individual adjustment screen is displayed.
- 6) Press ▲▼◀▶ to adjust.

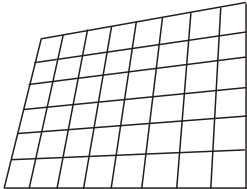
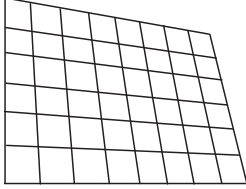
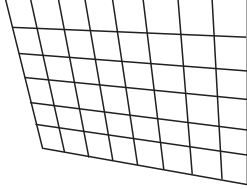
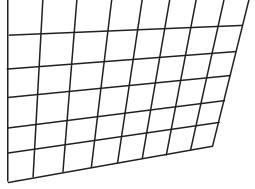
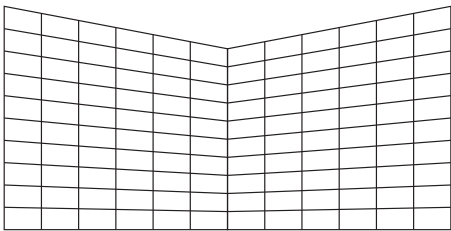
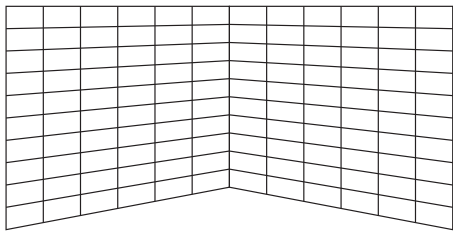
[6POINT CORRECTION]			
[UPPER LEFT] 	[UPPER RIGHT] 	[LOWER LEFT] 	[LOWER RIGHT] 
[UPPER MIDDLE] 		[LOWER MIDDLE] 	

Note

- Pressing the <ENTER> button while the individual adjustment screen is displayed can switch to the individual adjustment screen of other items.

[SHIFT]

(Only for COMPUTER1 / COMPUTER2 input)

Move the image position vertically or horizontally if the image position projected on the screen is shifted even when the relative position of the projector and the screen is installed correctly.

- 1) Press ▲▼ to select [SHIFT].
- 2) Press the <ENTER> button.
 - The [SHIFT] screen is displayed.
- 3) Press ▲▼◀▶ to adjust the position.

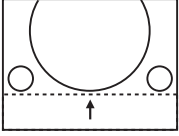
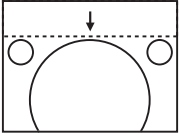
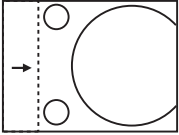
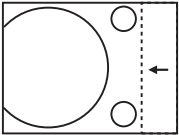
Orientation	Operation	Adjustment	
Vertical (up and down) adjustment.	Press the ▲ button.	The image position moves up.	
	Press the ▼ button.	The image position moves down.	
Horizontal (right and left) adjustment.	Press the ▶ button.	The image position moves to the right.	
	Press the ◀ button.	The image position moves to the left.	

Note

- Depending on the input signal, if the adjustment of [SHIFT] exceeds the effective adjustment range of the input signal, the position of the image cannot be changed. Adjust within the effective adjustment range.

[DOT CLOCK]

(Only for COMPUTER1 input / COMPUTER2 input)

Adjust to reduce noise generated when projecting vertical stripes.

When projecting a striped pattern, periodic stripes (noise) may occur. In this case, adjust so that the noise is the least.

- 1) Press ▲▼ to select [DOT CLOCK].
- 2) Press ◀▶ or the <ENTER> button.
 - The [DOT CLOCK] individual adjustment screen is displayed.
- 3) Press ◀▶ to adjust.
 - The adjustment values are [-32] to [+32].

Attention

- Set it before adjusting [CLOCK PHASE].

[CLOCK PHASE]

(Only for COMPUTER1 input / COMPUTER2 input)

You can adjust to achieve an optimal image when there is a flickering image or smeared outlines.

- 1) Press ▲▼ to select [CLOCK PHASE].
- 2) Press ◀▶ or the <ENTER> button.
 - The [CLOCK PHASE] individual adjustment screen is displayed.
- 3) Press ◀▶ to adjust the value.

- Adjustment value will change between [-16] and [+16]. Adjust so that the amount of interference is at a minimum.

Note

- Certain signals may not be adjustable.
- Optimal value may not be achieved if the output from the input computer is unstable.
- To project an image signal with dot clock frequency with 162 MHz or higher, noise may not disappear even if [CLOCK PHASE] is adjusted.

[OVER SCAN]

(Only for video signal input)

Use this function when characters or pictures are cropped near the periphery of the projected image.

- 1) Press ▲▼ to select [OVER SCAN].
- 2) Press ◀▶ or the <ENTER> button.
 - The [OVER SCAN] individual adjustment screen is displayed.
- 3) Press ◀▶ to adjust the level.
 - The adjustment values are [0] to [+3].

[ASPECT]

You can switch the aspect ratio of the image.

The aspect ratio is switched within the screen range selected in the [DISPLAY OPTION] menu → [SCREEN SETTING] → [SCREEN FORMAT]. Set [SCREEN FORMAT] first. (➡ page 84)

- 1) Press ▲▼ to select [ASPECT].
- 2) Press ◀▶ or the <ENTER> button.
 - The [ASPECT] individual adjustment screen is displayed.
- 3) Press ◀▶ to switch the item.
 - The items will switch each time you press the button.

[NORMAL]	Displays images without changing the aspect ratio of the input signals.
[WIDE]	Displays images with the aspect ratio converted to 16:9 when standard signals*1 are input. Display images without changing the aspect ratio of the input signal when wide-screen signals*2 are input.
[H FIT]	Displays images with the full width of the screen range selected in [SCREEN FORMAT]. When signals have the aspect ratio vertically greater than the screen aspect ratio selected in [SCREEN FORMAT], the images are displayed with the top and bottom parts cut off.
[V FIT]	Displays images with the full height of the screen range selected in [SCREEN FORMAT]. When signals have the aspect ratio horizontally greater than the screen aspect ratio selected in [SCREEN FORMAT], the images are displayed with the right and left parts cut off.
[FULL]	Displays images to the full screen range selected in [SCREEN FORMAT]. If the aspect ratio of the input signal is different from the aspect ratio of the screen range, it is converted to the screen aspect ratio selected in [SCREEN FORMAT] and displayed.
[NATIVE]	Displays images without changing the resolution of the input signals.

*1 Standard signals are input signals with an aspect ratio of 4:3 or 5:4.

*2 Wide-screen signals are input signals with an aspect ratio of 16:10, 16:9 or 15:9.

Note

- Some size modes are not available for certain types of input signals.
- If an aspect ratio which is different from the aspect ratio for the input signals is selected, the images will appear differently from the originals. Be careful of this when selecting the aspect ratio.
- If using the projector in places such as cafes or hotels to display programs for a commercial purpose or for public presentation, note that adjusting the aspect ratio or using the zoom function to change the screen images may be an infringement of the rights of the original copyright owner for that program under copyright protection laws. Take care when using a function of the projector such as the aspect ratio adjustment and zoom function.
- If conventional (normal) 4:3 images which are not wide-screen images are displayed on a wide screen, the edges of the images may not be visible or they may become distorted. Such images should be viewed as with an aspect ratio of 4:3 in the original format intended by the creator of the images.

[FRAME LOCK]

(Only for computer signals input)

The frame lock function can be set for some signals.

- 1) Press ▲▼ to select [FRAME LOCK].
- 2) Press ◀▶ or the <ENTER> button.
 - The [FRAME LOCK] individual adjustment screen is displayed.
- 3) Press ◀▶ to switch the item.
 - The items will switch each time you press the button.

[ON]	The frame is locked. Synchronizes the displayed image to the vertical scanning frequency of the input signal.
[OFF]	The frame lock function is turned off. Set to [OFF] if you are concerned about flickering.

[CLAMP POSITION]

You can adjust the optimal point when the black part of the image is blunt or it has turned green.

- 1) Press ▲▼ to select [CLAMP POSITION].
- 2) Press ◀▶ to adjust.

Status	Rough guide for optimal value	Range of adjustment
The black part is blunt.	The point where bluntness of the black part improves the most is the optimal value.	1 ~ 255
The black part is green.	The point where the green part becomes black, and the bluntness has improved is the optimal value.	

Note

- [CLAMP POSITION] can be adjusted only when a signal is input to the <COMPUTER 1 IN> terminal or the <COMPUTER 2 IN> terminal.
- Some signals may not be adjusted.

[LANGUAGE] menu

On the menu screen, select [LANGUAGE] from the main menu, and select an item from the submenu. Refer to “Navigating through the menu” (➔ page 65) for the operation of the menu screen.

Switching the display language

You can select the language of the on-screen display.

- 1) Press ▲▼ to select the display language, and press the <ENTER> button.

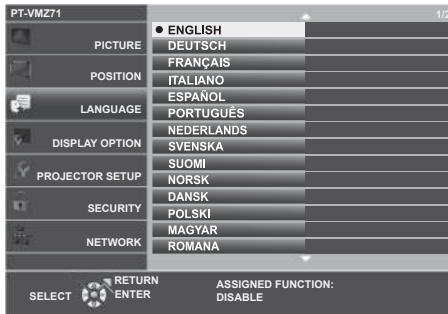

- Various menus, settings, adjustment screens, control button names, etc., are displayed in the selected language.
- The language can be changed to English, German, French, Italian, Spanish, Portuguese, Dutch, Swedish, Finnish, Norwegian, Danish, Polish, Hungarian, Romanian, Czech, Russian, Turkish, Arabic, Kazakh, Vietnamese, Korean, Simplified Chinese, Traditional Chinese, Japanese and Thai.

Note

- The on-screen display language is set to English in the factory default setting as well as when the [PROJECTOR SETUP] menu → [INITIALIZE ALL] is executed.

[DISPLAY OPTION] menu

On the menu screen, select [DISPLAY OPTION] from the main menu, and select an item from the submenu. Refer to “Navigating through the menu” (➔ page 65) for the operation of the menu screen.

[ON-SCREEN DISPLAY]

Set the on-screen display.

Setting [INPUT GUIDE]

Set the input guide to be displayed when switching the input. The input guide screen shows the currently selected input and input signal names.

- 1) Press ▲▼ to select [ON-SCREEN DISPLAY].
- 2) Press the <ENTER> button.
 - The [ON-SCREEN DISPLAY] screen is displayed.
- 3) Press ▲▼ to select [INPUT GUIDE].
- 4) Press ◀▶ to switch the item.
 - The items will switch each time you press the button.

[DETAILED]	Display the name of input terminal graphically, and display the input signal name or resolution of the selected input terminal.
[OFF]	Disables the input guide.
[SIMPLE]	Display the name of selected input terminal and input signal.

Note

- When it is set to [DETAILED], you can select the input with ▲▼◀▶ on the control panel or the remote control while the input guide is displayed.

Setting [OSD POSITION]

Set the position of the menu screen (OSD). In conjunction with this setting, the display position of the individual adjustment screen also changes.

- 1) Press ▲▼ to select [ON-SCREEN DISPLAY].
- 2) Press the <ENTER> button.
 - The [ON-SCREEN DISPLAY] screen is displayed.
- 3) Press ▲▼ to select [OSD POSITION].
- 4) Press ◀▶ to switch the item.
 - The items will switch each time you press the button.

Items	Menu screen (OSD)	Individual adjustment screen
[CENTER]	Sets it to the center of the screen.	It is displayed at the center of the screen.
[UPPER LEFT]	Sets it to the upper left of the screen.	It is displayed at the upper screen.
[UPPER RIGHT]	Sets it to the upper right of the screen.	It is displayed at the upper screen.
[LOWER LEFT]	Sets it to the lower left of the screen.	It is displayed at the lower screen.
[LOWER RIGHT]	Sets it to the lower right of the screen.	It is displayed at the lower screen.

Setting [OSD SIZE]

(Only for PT-VMZ71, PT-VMZ61, PT-VMZ51, PT-VMZ51S and PT-VMZ41)

Set the size of the menu screen (OSD).

- 1) Press ▲▼ to select [ON-SCREEN DISPLAY].
- 2) Press the <ENTER> button.
 - The [ON-SCREEN DISPLAY] screen is displayed.

3) Press ▲▼ to select [OSD SIZE].

4) Press ◀▶ to switch the item.

- The items will switch each time you press the button.

[NORMAL]	Use this setting normally.
[DOUBLE]	The menu screen is displayed with the font size twice as much as set in [NORMAL]. The menu screen size is doubled both vertically and horizontally.

Setting [WARNING MESSAGE]

Set the display/hide of the warning message.

1) Press ▲▼ to select [ON-SCREEN DISPLAY].

2) Press the <ENTER> button.

- The [ON-SCREEN DISPLAY] screen is displayed.

3) Press ▲▼ to select [WARNING MESSAGE].

4) Press ◀▶ to switch the item.

- The items will switch each time you press the button.

[ON]	Displays the warning message.
[OFF]	Hides the warning message.

Note

- When [WARNING MESSAGE] is set to [OFF], the warning message will not be displayed on the projected image even if a warning status such as "TEMPERATURE WARNING" is detected. The prompting message for filter replacement/maintenance will not be displayed either.

[HDMI SIGNAL LEVEL]

Switch the setting when the external equipment is connected to the <HDMI IN 1> terminal / <HDMI IN 2> terminal of the projector and the image is not projected correctly.

1) Press ▲▼ to select [HDMI SIGNAL LEVEL].

2) Press ◀▶ to switch the item.

- The items will switch each time you press the button.

[AUTO]	Sets the signal level automatically.
[64-940]	Select when the HDMI terminal of an external device (such as a blu-ray player) is connected to the <HDMI IN 1> terminal / <HDMI IN 2> terminal.
[0-1023]	Select when the DVI-D terminal output of an external device (such as a computer) is connected to the <HDMI IN 1> terminal / <HDMI IN 2> terminal via a conversion cable or similar cable. Select also when the HDMI terminal output of a computer or other device is connected to the <HDMI IN 1> terminal / <HDMI IN 2> terminal.

Note

- The optimal setting varies depending on the output setting of the connected external device. Refer to the operation instruction of the external device regarding the output of the external device.
- The displayed signal level is assumed when the input is 30 bits.

[DIGITAL LINK SIGNAL LEVEL]

(Not available for PT-VMZ51S and PT-VMZ41)

Switch the setting when the external equipment is connected to the <DIGITAL LINK/LAN> terminal of the projector and the image is not projected correctly.

1) Press ▲▼ to select [DIGITAL LINK SIGNAL LEVEL].

2) Press ◀▶ to switch the item.

- The items will switch each time you press the button.

[AUTO]	Automatically sets the signal level.
[64-940]	Select when the HDMI terminal output of an external device (such as a Blu-ray disc player) is connected to the <DIGITAL LINK/LAN> terminal via a twisted-pair-cable transmitter.
[0-1023]	Select when the DVI-D terminal output or HDMI terminal output of an external device (such as a computer) is connected to the <DIGITAL LINK/LAN> terminal via a twisted-pair-cable transmitter.

Note

- The optimal setting varies depending on the output setting of the connected external device. Refer to the operation instruction of the external device regarding the output of the external device.
- The displayed signal level is assumed when the input is 30 bits.

[SCREEN SETTING]

Set the screen size.

When changing the aspect of a projected image, correct to the optimum image position for the set screen. Set as necessary for the screen in use.

- 1) Press ▲▼ to select [SCREEN SETTING].
- 2) Press the <ENTER> button.
 - The [SCREEN SETTING] screen is displayed.
- 3) Press ▲▼ to select [SCREEN FORMAT].
- 4) Press ◀▶ to switch the [SCREEN FORMAT] item.
 - The items will switch each time you press the button.

[SCREEN FORMAT]	The available items to set when [SCREEN POSITION] is selected
[16:10]	Cannot be set.
[16:9]	Three items of [CENTER], [HIGH] and [LOW] can be selected for vertical position.
[4:3]	Three items of [CENTER], [LEFT] and [RIGHT] can be selected for horizontal position.

- If [SCREEN FORMAT] is set to [16:10], the [SCREEN POSITION] cannot be set.
- When [16:9] or [4:3] is selected, proceeds to Step 5).

- 5) Press ▲▼ to select [SCREEN POSITION].
- 6) Press ◀▶ to set the screen position.

[STARTUP LOGO]

Set the logo display when the power is turned on.

- 1) Press ▲▼ to select [STARTUP LOGO].
- 2) Press ◀▶ to switch the item.
 - The items will switch each time you press the button.

[DEFAULT LOGO]	Displays the Panasonic logo.
[USER LOGO]	Displays the image registered by the user.
[OFF]	Disables the startup logo display.

Note

- When [USER LOGO] is selected, the display of the startup logo will be kept for approximately 15 seconds.
- To create/register the [USER LOGO] image, use "Logo Transfer Software". The software can be downloaded from the Website (<https://panasonic.net/cns/projector/>).
- When transferring logos via the optional DIGITAL LINK output supported device (Model No.: ET-YFB100G, ET-YFB200G), setting for "NO SIGNAL SLEEP" of the DIGITAL LINK output supported device should be set to "OFF" to avoid interruption of communication.
- If the [PROJECTOR SETUP] menu → [ECO MANAGEMENT] → [QUICK STARTUP] is set to [ON], the startup logo is not displayed when projection starts before the specified time elapses after the projector enters the standby mode.
The specified time is a time set in the [PROJECTOR SETUP] menu → [ECO MANAGEMENT] → [QUICK STARTUP] → [VALID PERIOD].

[SHUTTER SETTING]

Enable/disable the shutter function automatically (shutter: closed/open) when the power is turned on.

- 1) Press ▲▼ to select [SHUTTER SETTING].
- 2) Press the <ENTER> button.
 - The [SHUTTER SETTING] screen is displayed.
- 3) Press ▲▼ to select [STARTUP].

4) Press ◀▶ to switch the item.

[OFF]	Starts projection with the shutter function disabled (shutter: open) when the power is turned on.
[ON]	Starts projection with the shutter function enabled (shutter: closed) when the power is turned on.

[AUTO SETUP SETTING]

Set the automatic execution of AUTO SETUP.

Dot clock, clock phase and image position can be adjusted automatically without pressing the <AUTO SETUP> button each time when unregistered signals are input frequently at meetings, etc.

1) Press ▲▼ to select [AUTO SETUP SETTING].

2) Press ◀▶ to switch the item.

- The items will switch each time you press the button.

[AUTO]	If the image being projected changes to an unregistered signal, the auto setup is automatically performed.
[BUTTON]	Enables the auto setup function only when the <AUTO SETUP> button is pressed.

[SIGNAL SEARCH]

Set to enable/disable the signal search function.

If the signal search function is enabled, the input with input signal is automatically selected when the power is turned on and the projection is started. In addition, if the <AUTO SETUP> button is pressed when the currently selected input has no signal, it automatically switches to the input with input signal.

1) Press ▲▼ to select [SIGNAL SEARCH].

2) Press ◀▶ to switch the item.

- The items will switch each time you press the button.

[ON]	Enables the input detection function.
[OFF]	Disables the input detection function.

[BACK COLOR]

Set the display of the projected screen when there is no signal input.

1) Press ▲▼ to select [BACK COLOR].

2) Press ◀▶ to switch the item.

- The items will switch each time you press the button.

[BLUE]	Displays the entire projection area in blue.
[BLACK]	Displays the entire projection area in black.
[DEFAULT LOGO]	Displays the Panasonic logo.
[USER LOGO]	Displays the image registered by the user.

Note

- To create/register the [USER LOGO] image, use "Logo Transfer Software". The software can be downloaded from the Website (<https://panasonic.net/cns/projector/>).
- When transferring logos via the optional DIGITAL LINK output supported device (Model No.: ET-YFB100G, ET-YFB200G), setting for "NO SIGNAL SLEEP" of the DIGITAL LINK output supported device should be set to "OFF" to avoid interruption of communication.

[P-TIMER]

Set and operate the presentation timer function.

Setting the mode

1) Press ▲▼ to select [P-TIMER].

2) Press the <ENTER> button.

- The [P-TIMER] screen is displayed.

3) Press ▲▼ to select [MODE].

4) Press ◀▶ to switch the item.

- The items will switch each time you press the button.

[COUNT UP]	Displays the elapsed time since the count was started.
[COUNT DOWN]	Displays the remaining time of the time set by [TIMER].

Setting the countdown timer

1) Press ▲▼ to select [P-TIMER].

2) Press the <ENTER> button.

- The [P-TIMER] screen is displayed.

3) Press ▲▼ to select [TIMER].

4) Press ◀▶ to set the time.

- The time can be set in 1-minute increments from 1 to 180 minutes.
- The factory default value is 10 minutes.

Note

- [TIMER] can be set when [MODE] is set to [COUNT DOWN].

Using the presentation timer

1) Press ▲▼ to select [P-TIMER].

2) Press the <ENTER> button.

- The [P-TIMER] screen is displayed.

3) Press ▲▼ to select the item, and press the <ENTER> button.

[START]	The count is started.
[STOP]	The count is stopped.
[RESTART]	The count is resumed.
[RESET]	The count is reset.
[EXIT]	The presentation timer function is ended.

- When [START] or [RESTART] is selected, the elapsed time or the remaining time is displayed at the lower right of the projected image.
- When [STOP] is selected, the elapsed time or the remaining time when the count was stopped is displayed at the lower right of the projected image.

Note

- Presentation timer operations are also possible by the <P-TIMER> button on the remote control. (➡ page 61)
- The security message set in the [SECURITY] menu → [TEXT DISPLAY] (➡ page 101) is not displayed when the elapsed time or remaining time is displayed.
- The elapsed time or remaining time is not displayed when the menu screen is displayed.
- The start time becomes "000:00" when [MODE] is set to [COUNT UP].
- The start time becomes the value set at [TIMER] when [MODE] is set to [COUNT DOWN].
- The time gauge turns clockwise when [COUNT UP] is set, and turns counterclockwise when [COUNT DOWN] is set.

[UNIFORMITY]

Color unevenness may change depending on the zoom position of the lens. Change the setting according to the zoom position so that color unevenness is minimized.

1) Press ▲▼ to select [UNIFORMITY].

2) Press the <ENTER> button.

- The [UNIFORMITY] screen is displayed.

3) Press ◀▶ to adjust the zoom correction.

- The items will switch each time you press the button.

[0]	Select [0] when the lens is at the wide end (W) for the best color unevenness correction.
[1] - [7]	Select from [1] to [7] for the best color unevenness correction.
[8]	Select [8] when the lens is at the tele end (T) for the best color unevenness correction.

[OTHER FUNCTIONS]

The same function can be realized by operating the menu as an alternative of operating the remote control button.

Using the auto setup function

The dot clock, clock phase and image position can be adjusted automatically when the analog RGB still image signal is input.

- 1) Press ▲▼ to select [OTHER FUNCTIONS].
- 2) Press the <ENTER> button.
 - The [OTHER FUNCTIONS] screen is displayed.
- 3) Press ▲▼ to select [AUTO SETUP].
- 4) Press the <ENTER> button.

Using the freeze function

The projected image is paused temporarily and the sound is stopped regardless of the playback of the external equipment.

- 1) Press ▲▼ to select [OTHER FUNCTIONS].
- 2) Press the <ENTER> button.
 - The [OTHER FUNCTIONS] screen is displayed.
- 3) Press ▲▼ to select [FREEZE].
- 4) Press the <ENTER> button.
 - The image is paused and the sound is turned off.

Note

- Press the <FREEZE> button again in freeze status, the paused image is played and the sound is output.
- [FREEZE] is displayed at the lower left of the projection screen in freeze status.

Using the shutter function

Enable (shutter: closed) or disable (shutter: open) the shutter function.

- 1) Press ▲▼ to select [OTHER FUNCTIONS].
- 2) Press the <ENTER> button.
 - The [OTHER FUNCTIONS] screen is displayed.
- 3) Press ▲▼ to select [SHUTTER].
- 4) Press the <ENTER> button.
 - The image and the sound are turned off.

Note

- Even when the shutter function is in use (shutter: closed), the power <⏻/> button, input select buttons (<HDMI 1>, <HDMI 2>, <DIGITAL LINK>, <COMPUTER 1/2>, <NETWORK / USB>), and <INPUT SELECT> button can be operated.

Using the digital zoom function

(Only for the computer signals.)

This function can enlarge the projected image.

- 1) Press ▲▼ to select [OTHER FUNCTIONS].
- 2) Press the <ENTER> button.
 - The [OTHER FUNCTIONS] screen is displayed.
- 3) Press ▲▼ to select [DIGITAL ZOOM].
- 4) Press the <ENTER> button.

- The image with the center part magnified 1.5 times is displayed, and the **[DIGITAL ZOOM]** individual adjustment screen is displayed.
- 5) **Press ◀▶ to adjust the magnification.**
 - The magnification can be adjusted from 1.0 to 3.0 times with increments of 0.1.
 - 6) **Press the <ENTER> button.**
 - The operation guide is displayed at the lower left of the screen.
 - 7) **Move the enlarged part.**
 - The image cannot be moved if the magnification is 1.0.

Note

- The digital zoom function is disabled when the freeze function is in use.
- Depending on the input signal, the digital zoom may not work.
- The digital zoom function is canceled if the input signal changes during a digital zoom.

[PROJECTOR SETUP] menu

On the menu screen, select [PROJECTOR SETUP] from the main menu, and select an item from the submenu. Refer to “Navigating through the menu” (➔ page 65) for the operation of the menu screen.

[STATUS]

Display the status of the projector.

- 1) Press ▲▼ to select [STATUS].
- 2) Press the <ENTER> button.
 - The [STATUS] screen is displayed.
- 3) Press ▲▼ to switch the pages.
 - The page will change each time you press the button.

[SIGNAL]	[NAME]	Displays the name of input signal.
	[FREQUENCY]	Displays the scanning frequency of input signal.
[RUNTIME]	[PROJECTOR]	Displays the actual usage time of projector.
	[LIGHT RUNTIME]	Displays the runtime of the light source.
	[CONTINUOUS LIGHTING TIME]	Displays the elapsed time from when the light source is illuminated. The elapsed time is reset when the light source is temporarily turned off such as using the shutter function.
[SERIAL NUMBER]	[PROJECTOR]	Displays the serial number of the projector.
[VERSION]	[MAIN]	Displays the main version of the firmware of the projector.
	[SUB]	Displays the sub version of the firmware of the projector.
	[LD]	Displays the version of the light driver of the projector.

Note

- For the network status, refer to the [NETWORK] menu → [NETWORK STATUS]. (➔ page 106)

[PROJECTOR ID]

The projector has an ID number setting function that can be used when multiple projectors are used side by side to enable simultaneous control or individual control via a single remote control.

- 1) Press ▲▼ to select [PROJECTOR ID].
- 2) Press ◀▶ to select a projector ID.
 - To select one item among [ALL] and [1] ~ [64].

[ALL]	Select when controlling projectors without specifying an ID number.
[1] ~ [64]	Select when specifying an ID number to control individual projector.

Note

- To specify an ID number for individual control, the ID number of a remote control must match the ID number of the projector.
- When the ID number is set to [ALL], the projector will operate regardless of the ID number specified during remote control or computer control.
If multiple projectors are set up side by side with ID set to [ALL], you cannot control a projector separately by specifying a different ID number.
- Refer to “Setting the ID number on the remote control” (➔ page 63) for how to set the ID number on the remote control.

[INITIAL START UP]

Set the startup method when the projector is switched on after connecting the power plug to outlet .

- 1) Press ▲▼ to select [INITIAL START UP].
- 2) Press ◀▶ to switch the item.
 - The items will switch each time you press the button.

[LAST MEMORY]	Starts up in the status that before removing the power plug from the outlet or turning off the circuit breaker.
[STANDBY]	Starts up in the standby mode.
[ON]	Starts the projection immediately.

[PROJECTION METHOD]

Set the projection method in accordance with the installation status of the projector.
Change the projection method if the screen display is upside down or inverted.

- 1) Press ▲▼ to select [PROJECTION METHOD].
- 2) Press ◀▶ to switch the projection method.
 - The items will switch each time you press the button.

[AUTO]	Detects the projector's posture with built-in angle sensor, then switches to [FRONT/DESK] or [FRONT/CEILING]. Usually it is set to [AUTO] when projecting in front of the screen.
[FRONT/DESK]	When installing the projector on the desk, etc., in front of the screen.
[FRONT/CEILING]	When installing the projector in front of the screen with the Ceiling Mount Bracket (optional).
[REAR/DESK]	When installing the projector on the desk, etc., behind the screen (with a translucent screen).
[REAR/CEILING]	When installing the projector behind the screen (with a translucent screen) with the Ceiling Mount Bracket (optional).

Note

- Refer to "Angle sensor" (➔ page 35) for details on the range of the installation attitude that can be detected by the built-in angle sensor.

[ECO MANAGEMENT]

Set [ECO MANAGEMENT] to reduce the power consumption and enhance the life of the light source.

Setting [AUTO POWER SAVE]

Set whether or not to enable the [AMBIENT LIGHT DETECTION] or [SIGNAL DETECTION] function.

- 1) Press ▲▼ to select [ECO MANAGEMENT].
- 2) Press the <ENTER> button.
 - The [ECO MANAGEMENT] screen is displayed.
- 3) Press ▲▼ to select [AUTO POWER SAVE].
- 4) Press ◀▶ to switch the item.
 - The items will switch each time you press the button.

[ON]	Enables the energy conservation setting.
[OFF]	Disables the energy conservation setting.

- Proceed to Step 5) when [ON] is selected.

- 5) Press ▲▼ to select [AMBIENT LIGHT DETECTION] or [SIGNAL DETECTION].

[AMBIENT LIGHT DETECTION]	Perform the setting of the ambient light detection. When enabled, the power of the light source can be adjusted according to the ambient brightness of the installation location.
[SIGNAL DETECTION]	Perform the setting of the signal detection. When enabled, the power of the light source can be reduced when no signal is detected.

- 6) Press ◀▶ to switch the item.
 - The items will switch each time you press the button.

[ON]	Enables the selected function.
[OFF]	Disables the selected function.

Note

- When [AUTO POWER SAVE] is set to [OFF], settings of [AMBIENT LIGHT DETECTION] and [SIGNAL DETECTION] are unavailable.
- The luminance may not be detected correctly when an object is placed on top of the projector, blocking the luminance sensor. In such a case, it may not operate properly even if [AMBIENT LIGHT DETECTION] is set to [ON].

Setting [LIGHT POWER]

- 1) Press ▲▼ to select [ECO MANAGEMENT].

- 2) Press the <ENTER> button.
 - The [ECO MANAGEMENT] screen is displayed.
- 3) Press ▲▼ to select [LIGHT POWER].
- 4) Press ◀▶ to switch the item.
 - The items will switch each time you press the button.

[NORMAL]	Select this item when high luminance is required. The light power is 100 % and the estimated runtime is approximately 20 000 hours*1.
[ECO]	The luminance will decrease compared to [NORMAL], but select this item to suppress the reduction in luminance against the runtime of the light source. The light power is 70 % and the estimated runtime is approximately 24 000 hours*1.
[QUIET]	Select this item to prioritize the operation with low noise. The light power is 70 % and the estimated runtime is approximately 20 000 hours*1.
[USER]	Select the item to set the picture brightness as desired.

*1 Estimated runtime is the time until the brightness decreases to approximately half of the time of delivery when the projector is used with the [PICTURE] menu → [DYNAMIC CONTRAST] set to [2] and under environment of 0.15 mg/m³ dust.
The value of runtime is just an estimate, and is not the warranty period.

- Proceed to Step 5) when [USER] is selected.

- 5) Press ▲▼ to select [LIGHT OUTPUT].
- 6) Press ◀▶ to adjust.

Operation	Adjustment		Range of adjustment
	Brightness	Runtime (estimate)	
Press ▶.	The screen becomes brighter.	The runtime becomes shorter.	50 %*1 - 100 %
Press ◀.	The screen becomes darker.	The runtime becomes longer.	

*1 It should be noted that the picture quality tends to deteriorate as the light output decreases.

Note

- Under influences of characteristics of each light source, conditions of use, installation environment, etc., the runtime may be shorter than the estimation.
- Runtime is a time until the luminance of the light source to become about half when using the projector continuously. The runtime is just an estimate, and is not the warranty period.
- If the runtime exceeds 10 000 hours, replacement of the components inside the projector may be required. Consult your dealer for details.

Setting [POWER MANAGEMENT]

This is a function to set the power of the projector to standby state or ready state automatically when there is no input signal for specific time. Selection of standby state or the ready state, and the time for the power management function to operate can be set.

- 1) Press ▲▼ to select [ECO MANAGEMENT].
- 2) Press the <ENTER> button.
 - The [ECO MANAGEMENT] screen is displayed.
- 3) Press ▲▼ to select [POWER MANAGEMENT].
- 4) Press ◀▶ to switch the item.
 - The items will switch each time you press the button.

[SHUT DOWN]	The countdown timer is displayed when the signal input is not present for 30 seconds, and the light source is turned off, and goes into standby after cooling when the time set in [TIMER] has elapsed.
[OFF]	Disables the power management function.
[READY]	The countdown timer is displayed when the signal input is not present for 30 seconds, and the light source is turned off, and goes into ready state after cooling when the time set in [TIMER] has elapsed. The light source will turn on and starts projection when a signal is input or the button is operated while in ready state.

- Proceed to Step 5) when anything other than [OFF] is selected.

- 5) Press ▲▼ to select [TIMER].

6) Press ◀▶ to switch the time.

- The setting time will switch each time you press the button.
- The time for the power management function to operate can be set from 5 minutes to 120 minutes in five-minute interval.

Note

- The power management function also works under Memory Viewer input. The condition to determine as no-signal input is as follows: no USB memory is attached to the <USB (VIEWER/WIRELESS/DC OUT)> terminal
- The power management function does not work under NETWORK input.

Setting [STANDBY MODE]

Set the power consumption during standby and whether to enable the [QUICK STARTUP] function.

1) Press ▲▼ to select [ECO MANAGEMENT].

2) Press the <ENTER> button.

- The [ECO MANAGEMENT] screen is displayed.

3) Press ▲▼ to select [STANDBY MODE].

4) Press ◀▶ to switch the item.

- The items will switch each time you press the button.

[NORMAL]	Select this item when using the network function during standby.
[ECO]	Select this item to reduce power consumption during standby.

- Proceed to Step 5) when [NORMAL] is selected.

5) Press ▲▼ to select [QUICK STARTUP].

6) Press ◀▶ to switch the item.

- The items will switch each time you press the button.

[OFF]	Disables the [QUICK STARTUP] function.
[ON]	Enables the [QUICK STARTUP] function until the specified time set in [VALID PERIOD] elapses after the projector enters the standby mode. The time until the projection starts after the power is turned on will be reduced during the period when the [QUICK STARTUP] function is valid.

- Proceed to Step 7) when [ON] is selected.

7) Press the <ENTER> button.

- The [QUICK STARTUP] screen is displayed.

8) Press ◀▶ to switch [VALID PERIOD].

- The items will switch each time you press the button.

[30MIN.]	Sets the time until the [QUICK STARTUP] function is disabled after the projector enters the standby mode.
[60MIN.]	
[90MIN.]	

Note

- When [STANDBY MODE] is set to [NORMAL], the network function can be used during standby.
- When the [PROJECTOR SETUP] menu → [ECO MANAGEMENT] → [STANDBY MODE] is set to [NORMAL], the <USB (VIEWER/WIRELESS/DC OUT)> terminal can supply power even in standby state. If set to [ECO], the <USB (VIEWER/WIRELESS/DC OUT)> terminal can not supply power in standby state.
- When [STANDBY MODE] is set to [ECO], the network function and the audio output function cannot be used during standby. Also, some RS-232C commands cannot be used.
- When [STANDBY MODE] is set to [ECO], it takes longer for the projection to start after the power is turned on, compared to when set to [NORMAL].
- [QUICK STARTUP] cannot be set when [STANDBY MODE] is set to [ECO].
- When [QUICK STARTUP] is set to [ON], the power consumption during standby becomes high during the period when the [QUICK STARTUP] function is valid.
- If [QUICK STARTUP] is set to [ON], the [QUICK STARTUP] function is disabled when the time set in [VALID PERIOD] elapses after the projector enters the standby mode. The startup time and power consumption will be the same as when [QUICK STARTUP] is set to [OFF].
- When [QUICK STARTUP] is set to [ON], the power indicator <ON (G)/STANDBY (R)> blinks red while in the standby mode during the period when the [QUICK STARTUP] function is valid. When [IN STANDBY MODE] in [AUDIO SETTING] is set to [OFF], the power indicator <ON

(G)/STANDBY (R)> will change to a red light when the specified time set in [VALID PERIOD] elapses after the projector enters the standby mode. When [IN STANDBY MODE] in [AUDIO SETTING] is set to [ON], even [QUICK STARTUP] is set to [ON], the power indicator <ON (G)/STANDBY (R)> will not change to a red light when the specified time set in [VALID PERIOD] elapses.

- When [QUICK STARTUP] is set to [ON], the standby period when the [QUICK STARTUP] function is valid will be added as the projector runtime.

[RS-232C]

Set the communication condition of the <SERIAL IN> terminal. Refer to “<SERIAL IN> terminal” (➔ page 160).

Setting the communication condition of the <SERIAL IN> terminal

- 1) Press ▲▼ to select [RS-232C].
- 2) Press the <ENTER> button.
 - The [RS-232C] screen is displayed.
- 3) Press ▲▼ to select [INPUT SELECT].
- 4) Press ◀▶ to switch the item.

[PROJECTOR]	Performs the RS-232C communication with the <SERIAL IN> terminal of the projector.
[DIGITAL LINK]	Performs the RS-232C communication via the optional DIGITAL LINK output supported device (Model No.: ET-YFB100G, ET-YFB200G) and the <DIGITAL LINK/LAN> terminal.

- 5) Press ▲▼ to select [BAUDRATE].
- 6) Press ◀▶ to switch the item.
 - The items will switch each time you press the button.

[9600]	Select the proper communication speed.
[19200]	
[38400]	

- 7) Press ▲▼ to select [PARITY].
- 8) Press ◀▶ to switch the item.
 - The items will switch each time you press the button.

[NONE]	Select the parity condition.
[EVEN]	
[ODD]	

Note

- For PT-VMZ51S and PT-VMZ41, [INPUT SELECT] menu is greyed out and can not be selected.
- When [INPUT SELECT] is set to [DIGITAL LINK], communication using that serial terminal is available only when the corresponding device (such as the optional DIGITAL LINK output supported device (Model No.: ET-YFB100G, ET-YFB200G)) is connected to the <DIGITAL LINK/LAN> terminal.
- When transferring logos via the optional DIGITAL LINK output supported device (Model No.: ET-YFB100G, ET-YFB200G), setting for “NO SIGNAL SLEEP” of the DIGITAL LINK output supported device should be set to “OFF” to avoid interruption of communication.
- When [INPUT SELECT] is set to [DIGITAL LINK], communication speed for input is fixed to 9 600 bps.

Using the control command for the existing projector

Set this function when using the control command for previously purchased Panasonic projector to control this projector with a computer using the <SERIAL IN> terminal on the projector. The existing Panasonic projector control software, etc., can continually be used.

- 1) Press ▲▼ to select [RS-232C].
- 2) Press the <ENTER> button.
 - The [RS-232C] screen is displayed.
- 3) Press ▲▼ to select [EMULATE].

- 4) Press the <ENTER> button.
 - The [EMULATE] screen is displayed.
- 5) Press ▲▼ to select an item.

[OFF]	Does not use existing control command for the projector.
[D3500]	D3500 series
[D4000]	D4000 series
[D/W5k SERIES]	D5700 series, DW5100 series, D5600 series, DW5000 series, D5500 series
[D/W/Z6k SERIES]	DZ870 series, DW830 series, DX100 series, DZ780 series, DW750 series, DX820 series, DZ770 series, DW740 series, DX810 series, DZ680 series, DW640 series, DX610 series, DW730 series, DX800 series, DZ6710 series, DZ6700 series, DW6300 series, D6000 series, D5000 series, DZ570 series, DW530 series, DX500 series, RZ970 series, RW930 series, RX110 series, RZ770 series, RZ660 series, RW730 series, RW620 series, RZ670 series, RW630 series, RZ575 series, RZ570 series
[L730 SERIES]	L730 series, L720 series, L520 series
[L780 SERIES]	L780 series, L750 series
[L735 SERIES]	L735 series
[L785 SERIES]	L785 series
[F/W SERIES]	FW430 series, FX400 series, FW300 series, F300 series, F200 series, FW100 series, F100 series
[LZ370]	LZ370 series
[LB/W SERIES]	LB3 series, LB2 series, LB1 series, ST10 series, LB90 series, LW80NT series, LB80 series, LB78 series, LB75 series
[VX500 SERIES]	VW435N series, VW440 series, VW430 series, VX505N series, VX510 series, VX500 series, VW330 series, VX400NT series, VX400 series, VX41 series
[EZ570 SERIES]	EZ570 series, EW630 series, EW530 series, EX600 series, EX500 series
[VW431D]	VW431D series

- 6) Press the <ENTER> button.

[FUNCTION BUTTON]

The function assigned to the <FUNCTION> button of the remote control is displayed. You can also release the assigned setting.

Releasing assigned function to the <FUNCTION> button

- 1) Press ▲▼ to select [FUNCTION BUTTON].
- 2) Press the <ENTER> button.
 - The [FUNCTION BUTTON] screen is displayed.
- 3) Press the <ENTER> button.
- 4) When the confirmation screen is displayed, press ◀▶ to select [OK] and press the <ENTER> button.

Note

- You can also cancel the assigned settings by displaying the on-screen menu, selecting the menu item to be canceled (main menu, submenu, or details menu), and then pressing the <FUNCTION> button for at least three seconds.

[AUDIO SETTING]

You can perform detailed audio setting.

Adjusting the volume

- 1) Press ▲▼ to select [AUDIO SETTING].
- 2) Press the <ENTER> button.
 - The [AUDIO SETTING] screen is displayed.
- 3) Press ▲▼ to select [VOLUME].
- 4) Press ◀▶ to adjust the level.

Operation	Adjustment	Range
Press the ► button.	Increases the volume.	0 ~ +63
Press the ◀ button.	Decreases the volume.	

Setting the mute status

- 1) Press ▲▼ to select [AUDIO SETTING].
- 2) Press the <ENTER> button.
 - The [AUDIO SETTING] screen is displayed.
- 3) Press ▲▼ to select [MUTE].
- 4) Press ◀▶ to switch the item.

[OFF]	Audio is output.
[ON]	Audio is muted.

Setting the audio output during standby

- 1) Press ▲▼ to select [AUDIO SETTING].
- 2) Press the <ENTER> button.
 - The [AUDIO SETTING] screen is displayed.
- 3) Press ▲▼ to select [IN STANDBY MODE].
- 4) Press ◀▶ to switch the item.
 - The items will switch each time you press the button.

[OFF]	Disables audio output in the standby mode.
[ON]	Enables audio output in the standby mode.

Note

- When the [PROJECTOR SETUP] menu → [ECO MANAGEMENT] → [STANDBY MODE] is set to [ECO], audio cannot be output during standby.
- When [IN STANDBY MODE] is set to [ON], you can adjust the volume with the <VOL-> button / <VOL+> button on the remote control or the control panel during standby.
- When [IN STANDBY MODE] is set to [ON], even [QUICK STARTUP] is set to [ON], the power indicator <ON (G)/STANDBY (R)> will not change to a red light when the specified time set in [VALID PERIOD] elapses.

Setting the audio input from the connected device

Choose the audio input terminal for each input signal.

- 1) Press ▲▼ to select [AUDIO SETTING].
- 2) Press the <ENTER> button.
 - The [AUDIO SETTING] screen is displayed.
- 3) Press ▲▼ to select the items of [AUDIO IN SELECT] to set.

[COMPUTER1]	Set the audio output for COMPUTER1 input.
[COMPUTER2]	Set the audio output for COMPUTER2 input.
[HDMI1]	Set the audio output for HDMI1 input.
[HDMI2]	Set the audio output for HDMI2 input.
[DIGITAL LINK]	Set the audio output for DIGITAL LINK input.
[MEMORY VIEWER]	Set the audio output for MEMORY VIEWER input.
[NETWORK]	Set the audio output for NETWORK input.

- 4) Press ◀▶ to switch the item.
 - The sub items will switch each time you press the button.

[AUDIO IN 1]	Audio connected to the <AUDIO IN 1> terminal is output during projection of image from the set input terminal.
[AUDIO IN 2]	Audio connected to the <AUDIO IN 2> terminal is output during projection of image from the set input terminal.

[HDMI1 AUDIO IN] ^{*1}	Audio input to HDMI1 is output.
[HDMI2 AUDIO IN] ^{*2}	Audio input to HDMI2 is output.
[DIGITAL LINK AUDIO IN] ^{*3}	Audio input to DIGITAL LINK is output.
[NETWORK AUDIO IN] ^{*4}	Audio input to NETWORK is output.

*1 Only for HDMI1 input.

*2 Only for HDMI2 input.

*3 Only for DIGITAL LINK input.

*4 Only for NETWORK input.

[TEST PATTERN]

Displays the test pattern built-in to the projector.

The settings such as [CONTRAST] or [BRIGHTNESS] that can be set from the [PICTURE] menu will not be reflected in the test pattern. Make sure to perform various adjustments with input signals displayed.

- 1) Press ▲▼ to select [TEST PATTERN].
- 2) Press the <ENTER> button.
 - The ALL WHITE test pattern is displayed.
- 3) Press ◀▶ to switch the test pattern.
 - The test pattern will switch each time you press the button.

All white	The test pattern is displayed together with the operation guide of [PATTERN SELECT]. Select your desired test pattern.
Color bar (Vertical)	
Color bar (Horizontal)	
Cross	
Cross (Inversion)	
Cross hatch	

Note

- If [TEST PATTERN] is assigned to the <FUNCTION> button on the remote control, the all white pattern will be displayed after pressing the <FUNCTION> button.

[FILTER COUNTER]

This function is used to check the usage time of the air filter or set the cleaning/replacement cycle of the air filter. Also, you can reset the air filter usage time.

- 1) Press ▲▼ to select [FILTER COUNTER].
- 2) Press the <ENTER> button.
 - The [FILTER COUNTER] screen is displayed.

[FILTER COUNTER]	Displays the usage time of the air filter.
[TIMER]	Sets the cleaning/replacement cycle of the air filter.
[FILTER COUNTER RESET]	Resets the air filter usage time.

Setting [TIMER]

If you want to regularly clean/replace the air filter, set its cycle time. When the air filter usage time reaches the set time, a message of "FILTER COUNTER has reached the set time" prompting you to clean/replace the air filter is displayed on the projection screen.

- 1) Press ▲▼ to select [FILTER COUNTER].
- 2) Press the <ENTER> button.
 - The [FILTER COUNTER] screen is displayed.
- 3) Press ▲▼ to select [TIMER].
- 4) Press ◀▶ to switch the item.
 - The items will switch each time you press the button.

[OFF]	Select not to display the message.
[1000H] - [20000H]	Select to display the message. You can set the cleaning/replacement cycle of the air filter.

Setting [FILTER COUNTER RESET]

Resets the usage time of the air filter.

- 1) Press ▲▼ to select [FILTER COUNTER].
- 2) Press the <ENTER> button.
 - The [FILTER COUNTER] screen is displayed.
- 3) Press ▲▼ to select [FILTER COUNTER RESET].
- 4) Press the <ENTER> button.
- 5) When the confirmation screen is displayed, press ◀▶ to select [OK] and then press the <ENTER> button.
 - The display of [FILTER COUNTER] changes to "0H".

[HDMI CEC]

Sets the CEC (Consumer Electronics Control) function of HDMI.

CEC is a function that is realized by exchanging device control signals with external devices connected with an HDMI cable. Using the remote control of the projector, it is possible to operate the CEC-compatible external device (hereinafter referred to as "CEC-compatible device") and to control the power on/off link status between the projector and the CEC-compatible device.

For details on how to use the CEC function, refer to "Using HDMI-CEC function" (➔ page 143).

- 1) Press ▲▼ to select [HDMI CEC].
- 2) Press ◀▶ to switch the item.
 - The items will switch each time you press the button.

[ON]	Enables the CEC function.
[OFF]	Disables the CEC function.

Operating a CEC-compatible device

Operate the CEC-compatible device connected to the <HDMI IN 1> terminal or <HDMI IN 2> terminal.

[HDMI-CEC OPERATION] can be operated when HDMI1 input or HDMI2 input is selected. Switch to the input that is corresponding to the CEC-compatible device you want to operate in advance.

- 1) Press ▲▼ to select [HDMI CEC].
- 2) Press ◀▶ to select [ON].
- 3) Press the <ENTER> button.
 - The [HDMI CEC] screen is displayed.
- 4) Press ▲▼ to select [HDMI 1] or [HDMI 2].
 - Select the input corresponding to the CEC-compatible device you want to operate.
 - Proceed to Step 6) when the device to operate is displayed.
- 5) Press ◀▶ to switch the item.
 - The devices will switch when multiple CEC-compatible devices are connected to one input.
 - Select the device to operate.
- 6) Press ▲▼ to select [HDMI-CEC OPERATION].
- 7) Press the <ENTER> button.
 - The HDMI-CEC operation screen is displayed.
- 8) Select the item displayed on the HDMI-CEC operation screen to operate the device.
 - Refer to the "Using HDMI-CEC function" (➔ page 143) for the operation details.

Note

- If no CEC-compatible device is connected to <HDMI IN 1> or <HDMI IN 2> terminal, there is no device displayed at [HDMI 1] or [HDMI 2] and [---] is displayed.
- To exit the HDMI-CEC operation screen, press the <RETURN> button or <MENU> button.

Changing the menu code

The menu code that calls up the operation menu of the CEC-compatible device varies depending on the device manufacturer. If you cannot call up the operation menu of a CEC-compatible device from the HDMI-CEC operation screen, change the menu code setting.

- 1) Press ▲▼ to select [HDMI CEC].
- 2) Press ◀▶ to select [ON].
- 3) Press the <ENTER> button.
 - The [HDMI CEC] screen is displayed.
- 4) Press ▲▼ to select [MENU CODE].
- 5) Press ◀▶ to switch the item.
 - The items will switch each time you press the button.
 - Select the menu code from [1] to [6].

Setting the link control

Make settings for the link control between the projector and CEC-compatible devices.

[PROJECTOR -> DEVICE]

Set the link control from the projector to the CEC-compatible device.

- 1) Press ▲▼ to select [HDMI CEC].
- 2) Press ◀▶ to select [ON].
- 3) Press the <ENTER> button.
 - The [HDMI CEC] screen is displayed.
- 4) Press ▲▼ to select [PROJECTOR -> DEVICE].
- 5) Press ◀▶ to switch the item.
 - The items will switch each time you press the button.

[DISABLE]	Disables the power link control from the projector to the CEC-compatible device. Select this when you do not want the power status of the CEC-compatible device to link with the power status of the projector.
[POWER OFF]	Enables power-off link control. When you turn off the power of the projector and put it in standby mode, all CEC-compatible devices connected to the <HDMI IN 1> terminal or <HDMI IN 2> terminal will enter standby mode. Power-on link control is disabled.
[POWER ON/OFF]	Enables power-on link control and power-off link control. If you turn on the projector and start projection with the HDMI1 input or HDMI2 input selected, the CEC-compatible device connected to the selected input will turn on. When you turn off the projector and put it in standby mode, all CEC-compatible devices connected to the <HDMI IN 1> terminal or <HDMI IN 2> terminal will enter standby mode.

[DEVICE -> PROJECTOR]

Set the link control from the CEC-compatible device to the projector.

- 1) Press ▲▼ to select [HDMI CEC].
- 2) Press ◀▶ to select [ON].
- 3) Press the <ENTER> button.
 - The [HDMI CEC] screen is displayed.
- 4) Press ▲▼ to select [DEVICE -> PROJECTOR].
- 5) Press ◀▶ to switch the item.
 - The items will switch each time you press the button.

[DISABLE]	Disables the power link control from the CEC-compatible device to the projector. Select this when you do not want the power status of the projector to link with the power status of the CEC-compatible device.
[POWER ON]	Enables power-on link control. While the projector is in standby, if the CEC-compatible device connected to the <HDMI IN 1> terminal or <HDMI IN 2> terminal is turned on or starts playing, the projector turns on, starts projection, and switches to the input that the linked CEC-compatible device is connected. While the projector is turned on, if the CEC-compatible device starts playing, the projector switches to the input that the CEC-compatible device is connected. Power-off link control is disabled.
[POWER ON/OFF]	Enables power-on link control and power-off link control. While the projector is in standby, if the CEC-compatible device connected to the <HDMI IN 1> terminal or <HDMI IN 2> terminal is turned on or starts playing, the projector turns on, starts projection, and switches to the input that the linked CEC-compatible device is connected. While the projector is turned on, if the CEC-compatible device starts playing, the projector switches to the input that the CEC-compatible device is connected. When the CEC-compatible device connected to the selected input is turned off, the projector enters standby mode.

Note

- If the CEC-compatible device does not support CEC 1.4, it may not support the link control described in the manual.
- Depending on the connected CEC-compatible device, the link control may not operate normally.

[INITIALIZE ALL]

Return various setting values to their factory default settings.

- 1) Press **▲▼** to select **[INITIALIZE ALL]**.
- 2) Press the **<ENTER>** button.
- 3) When the **[INITIALIZE ALL]** screen is displayed, press **◀▶** to select **[OK]** and then press the **<ENTER>** button.
- 4) When the power off confirmation screen is displayed after a while, press the **<ENTER>** button.
 - The operations except for powering off are disabled.

Note

- When the **[SECURITY]** menu → **[PASSWORD]** is set to **[ON]**, the **[PASSWORD]** screen will be displayed after selecting **[INITIALIZE ALL]** and pressing the **<ENTER>** button. Enter the security password set for the projector and continue your desired operation.
- The projector will enter the standby status to reflect the setting values when **[INITIALIZE ALL]** is executed.
- Even if **[INITIALIZE ALL]** is performed, the settings of the following items cannot be initialized.
 - **[STANDBY MODE]**
 - **[RS-232C]** → **[EMULATE]**
 - **[FILTER COUNTER]**
 - **[NETWORK]**
- To initialize the settings of **[NETWORK]**, perform the **[NETWORK]** menu → **[INITIALIZE]**.
- When **[INITIALIZE ALL]** is executed, the **[INITIAL SETTING]** screen is displayed when the projection starts next time.

[SECURITY] menu

On the menu screen, select [SECURITY] from the main menu, and select an item from the submenu. Refer to “Navigating through the menu” (➔ page 65) for the operation of the menu screen.

- When the projector is used for the first time
Initial password: Press ▲▶▼◀▲▶▼◀ in order, and press the <ENTER> button.

Attention

- When you select the [SECURITY] menu and press the <ENTER> button, entering a password is required. Enter the preset password and then continue operations of the [SECURITY] menu.
- When the password has been changed previously, enter the changed password, and press the <ENTER> button.

Note

- The entered password is displayed with "*" mark on the screen.
- An error message is displayed on the screen when the entered password is incorrect. Re-enter the correct password.

[PASSWORD]

Sets the security password entry.

If the security password entry is enabled, the [PASSWORD] screen will be displayed and the security password is required for the following cases.

- Connect the power plug to the outlet and turn the power on.
- Execute the [PROJECTOR SETUP] menu → [INITIALIZE ALL].
- Execute the [NETWORK] menu → [INITIALIZE].

1) Press ▲▼ to select [PASSWORD].

2) Press ◀▶ to switch the item.

- The items will switch each time you press the button.

[OFF]	Disables the security password entry.
[ON]	Enables the security password entry.

Note

- This item is set to [OFF] in the factory default setting or when the [PROJECTOR SETUP] menu → [INITIALIZE ALL] is executed. Set it to [ON] as necessary.
- Even it is set to [ON], the security password entry setting will not be effective until you turn off the power and reconnect the power plug to the outlet. If the entered password is incorrect when the power is turned on, the operation will be restricted to the power <⏻/⏪> button.

[PASSWORD CHANGE]

Change the security password.

1) Press ▲▼ to select [PASSWORD CHANGE].

2) Press the <ENTER> button.

- The [PASSWORD CHANGE] screen is displayed.

3) Press ▲▼◀▶ or number buttons (<0>-<9>) to set the password.

- Up to eight button operations can be set.

4) Press the <ENTER> button.

5) Re-enter the password for the confirmation.

6) Press the <ENTER> button.

Note

- The entered password is displayed with "*" mark on the screen.
- Change the password periodically and make it hard to guess.
- If numbers have been used for the security password, the security password will need to be initialized again if the remote control is lost. Consult your dealer for the initialization method.

[TEXT DISPLAY]

Overlap the security message (text) over the projecting image.

- 1) Press ▲▼ to select [TEXT DISPLAY].
- 2) Press ◀▶ to switch the item.
 - The items will switch each time you press the button.

[OFF]	The security message will not be displayed.
[ON]	Displays the text set at the [SECURITY] menu → [TEXT CHANGE].

[TEXT CHANGE]

Register or change the displayed text when [TEXT DISPLAY] is set to [ON].

- 1) Press ▲▼ to select [TEXT CHANGE].
- 2) Press the <ENTER> button.
 - The [TEXT CHANGE] screen is displayed.
- 3) Press ▲▼◀▶ to select the text, and press the <ENTER> button to enter the text.
- 4) Press ▲▼◀▶ to select [OK], and press the <ENTER> button.
 - The text is changed.
 - Up to 22 characters can be entered.

[MENU LOCK]

Display the menu by the <MENU> button and set whether or not to enable menu operations.

- 1) Press ▲▼ to select [MENU LOCK].
- 2) Press ◀▶ to switch the item.
 - The items will switch each time you press the button.

[OFF]	Enables menu operations.
[ON]	Disables menu operations.

Note

- The factory default setting or the setting after executing the [PROJECTOR SETUP] menu → [INITIALIZE ALL] is set to [OFF]. Set it to [ON] if necessary.
- When [MENU LOCK] is set to [ON], the [MENU LOCK PASSWORD] screen is displayed after pressing the <MENU> button. After entering the set menu lock password, the menu operation is enabled. In this case, the menu operation will remain enabled until the projector enters into standby mode.

[MENU LOCK PASSWORD]

Change the menu lock password.

- 1) Press ▲▼ to select [MENU LOCK PASSWORD].
- 2) Press the <ENTER> button.
 - The [MENU LOCK PASSWORD] screen is displayed.
- 3) Press ▲▼◀▶ to select the text, and press the <ENTER> button to enter the text.
 - Up to 16 characters can be input.
- 4) Press ▲▼◀▶ to select [OK], and press the <ENTER> button.
 - To cancel, select [CANCEL].

Attention

- The initial password is "AAAA" for the factory default setting or after executing the [PROJECTOR SETUP] menu → [INITIALIZE ALL].
- Change the password periodically and make it hard to guess.
- To initialize your password, consult your distributor.

[CONTROL DEVICE SETUP]

Enable/disable the button operations on the control panel and the remote control.

- 1) Press ▲▼ to select [CONTROL DEVICE SETUP].
- 2) Press the <ENTER> button.
 - The [CONTROL DEVICE SETUP] screen is displayed.
- 3) Press ▲▼ to select one item between [CONTROL PANEL] and [REMOTE CONTROLLER].

[CONTROL PANEL]	You can limit the control method to the control panel.
[REMOTE CONTROLLER]	You can limit the control method to the remote control.

- 4) Press ◀▶ to switch between [ENABLE] and [DISABLE].
 - You can limit the control method to the control panel or the remote control.

[ENABLE]	Enable the operation of all buttons.
[DISABLE]	Disable the operation of all buttons.

- When you change [ENABLE] to [DISABLE], proceed to Step 5).
- 5) When the confirmation screen is displayed, press ◀▶ to select [OK], and then press the <ENTER> button.

Note

- When a button operation is performed on the device set to [DISABLE] , the [PASSWORD] screen is displayed. To continue operations, enter the security password.
- The [PASSWORD] screen will disappear when there is no operation for approx. 10 seconds.
- If the operations of both [CONTROL PANEL] and [REMOTE CONTROLLER] are set to [DISABLE], the projector cannot be turned off (cannot enter standby).
- Even when you set button operations on the remote control to be disabled, operations of the <ID ALL> and <ID SET> buttons on the remote control are enabled.

[NETWORK] menu

On the menu screen, select [NETWORK] from the main menu, and select an item from the submenu. Refer to “Navigating through the menu” (⇒ page 65) for the operation of the menu screen.

- To use the wireless LAN function with the projector, it is necessary to attach the optional Wireless Module (Model No.: AJ-WM50).

[ETHERNET TYPE]

(Not available for PT-VMZ51S and PT-VMZ41)

Set the path for transmitting the Ethernet signal.

- 1) Press ▲▼ to select [ETHERNET TYPE].
- 2) Press ◀▶ to switch the item.
 - The items will switch each time you press the button.

[LAN]	Select this item when using only the <LAN> terminal to transmit the Ethernet signal.
[DIGITAL LINK]	Select this item when using only the <DIGITAL LINK/LAN> terminal to transmit the Ethernet signal.
[LAN & DIGITAL LINK]	Select this item when using the <DIGITAL LINK/LAN> terminal and the <LAN> terminal to transmit the Ethernet signal.

Note

- When [ETHERNET TYPE] is set to [LAN], the Ethernet and serial control signals cannot be transmitted via the optional DIGITAL LINK output supported device (Model No.: ET-YFB100G, ET-YFB200G) connected to the <DIGITAL LINK/LAN> terminal.
- When [ETHERNET TYPE] is set to [LAN & DIGITAL LINK], the <DIGITAL LINK/LAN> terminal and the <LAN> terminal are connected inside the projector. Do not directly connect the <DIGITAL LINK/LAN> terminal and the <LAN> terminal using a LAN cable. Construct the system so that it is not connected to the same network via the peripherals such as the switching hub or the twisted-pair-cable transmitter.

[DIGITAL LINK]

(Not available for PT-VMZ51S and PT-VMZ41)

Make settings and operations related to DIGITAL LINK.

[DIGITAL LINK MODE]

Switch the communication method of the <DIGITAL LINK/LAN> terminal of the projector.

- 1) Press ▲▼ to select [DIGITAL LINK].
- 2) Press the <ENTER> button.
 - The [DIGITAL LINK] screen is displayed.
- 3) Press ▲▼ to select [DIGITAL LINK MODE].
- 4) Press ◀▶ to switch the item.
 - The items will switch each time you press the button.

[AUTO]	Switches the communication method automatically to DIGITAL LINK, long reach or Ethernet.
[DIGITAL LINK]	Fixes the communication method to DIGITAL LINK.
[LONG REACH]	Fixes the communication method to long reach.
[ETHERNET]	Fixes the communication method to Ethernet.

Possible communication modes

✓: Communication possible

—: Communication not possible

Setting		Communication possibility			
		Image transfer (100 m (328'1"))	Image transfer (150 m (492'2"))	Ethernet	RS-232C
[AUTO]	For DIGITAL LINK	✓	—	✓	✓
	For long reach	—	✓	✓	✓
	For Ethernet	—	—	✓ ¹	—

Chapter 4 Settings - [NETWORK] menu

Setting	Communication possibility			
	Image transfer (100 m (328'1"))	Image transfer (150 m (492'2"))	Ethernet	RS-232C
[DIGITAL LINK]	✓	—	✓	✓
[LONG REACH]	—	✓	✓	✓
[ETHERNET]	—	—	✓ ¹	—

*1 Communication via a twisted-pair-cable transmitter is not available. Connect the projector to the network directly.

Note

- The maximum transmission distance between the twisted-pair-cable transmitter and the projector is 100 m (328'1") for the signal with resolution of 1 920 x 1 200 dots or less. For the signal with the resolution exceeding 1 920 x 1 200 dots, the maximum transmission distance will be 50 m (164'1").
- The maximum transmission distance when connected with the long-reach communication method is 150 m (492'2"). In this case, the signal that the projector can receive is only up to 1080/60p (1 920 x 1 080 dots, dot clock frequency 148.5 MHz).
- When the communication method of the twist-pair-cable transmitter is set to long reach, the projector will connect with long-reach communication method when [DIGITAL LINK MODE] is set to [AUTO]. To connect with the optional DIGITAL LINK Switcher (Model No.: ET-YFB200G) with the long-reach communication method, set [DIGITAL LINK MODE] to [LONG REACH].
- Connection will not be made correctly if the twist-pair-cable transmitter does not support the long-reach communication method even if [DIGITAL LINK MODE] is set to [LONG REACH].

[DIGITAL LINK STATUS]

Display the DIGITAL LINK connection environment.

- 1) Press **▲▼** to select **[DIGITAL LINK]**.
- 2) Press the **<ENTER>** button.
 - The **[DIGITAL LINK]** screen is displayed.
- 3) Press **▲▼** to select **[DIGITAL LINK STATUS]**.
- 4) Press the **<ENTER>** button.
 - The **[DIGITAL LINK STATUS]** screen is displayed.

[LINK STATUS]	The content of display is as follows. [DIGITAL LINK]: Communicating in the DIGITAL LINK method. [LONG REACH]: Communicating in the long reach method. [ETHERNET]: Communicating in the Ethernet method. [NO LINK]: Communication is not established.
[HDCP STATUS]	The content of display is as follows. [ON]: When protected with HDCP [OFF]: When not protected with HDCP [NO SIGNAL]: When there is no signal
[SIGNAL QUALITY]	[SIGNAL QUALITY] is a numerical value of the amount of error, and the display color changes to green, yellow, or red depending on that value. Check the signal quality level while receiving a signal from the twisted-pair-cable transmitter. <ul style="list-style-type: none"> • [MAX]/[MIN]: Maximum/minimum value of the amount of error. • Green (-12 dB or lower) → Normal signal quality level. • Yellow (-11 to -8 dB) → Warning level where there is the possibility of noise introduced on the screen. • Red (-7 dB or higher) → Abnormal level where synchronization may be interrupted or a signal may not be received.

[DIGITAL LINK MENU]

When the optional DIGITAL LINK output supported device (Model No.: ET-YFB100G, ET-YFB200G) is connected to the <DIGITAL LINK/LAN> terminal, the main menu of the connected DIGITAL LINK output supported device is displayed. Refer to the Operating Instructions of the DIGITAL LINK output supported device for details.

Note

- [DIGITAL LINK MENU] cannot be selected when the [NETWORK] menu → [DIGITAL LINK] → [EXTRON XTP] is set to [ON].

[EXTRON XTP]

Make connection setting for the “XTP transmitter” of Extron Electronics.

- 1) Press ▲▼ to select [DIGITAL LINK].
- 2) Press the <ENTER> button.
 - The [DIGITAL LINK] screen is displayed.
- 3) Press ▲▼ to select [EXTRON XTP].
- 4) Press ◀▶ to switch the item.
 - The items will switch each time you press the button.

[OFF]	Select this item when connecting the optional DIGITAL LINK output supported device (Model No.: ET-YFB100G, ET-YFB200G) to the <DIGITAL LINK/LAN> terminal.
[ON]	Select this item when connecting the “XTP transmitter” of Extron Electronics to the <DIGITAL LINK/LAN> terminal.

Note

- For details of the “XTP transmitter”, visit the website of Extron Electronics.
URL <http://www.extron.com/>

[WIRED LAN]

Perform the connection settings to use wired LAN.

- 1) Press ▲▼ to select [WIRED LAN].
- 2) Press the <ENTER> button.
 - The [WIRED LAN] screen is displayed.
- 3) Press ▲▼ to select [IP VERSION].
- 4) Press the <ENTER> button.
 - The [IP VERSION] screen is displayed.
- 5) Press ▲▼ to select an item, and press the <ENTER> button.

[IPv4]	Uses only the “IPv4” protocol.
[IPv6]	Uses only the “IPv6” protocol.
[IPv4 & IPv6]	Both the “IPv4” and the “IPv6” protocols can be used.

- 6) Press the <MENU> button.
 - The [WIRED LAN] screen is displayed.
 - Proceed to Step 10) when [IPv6] is selected.
- 7) Press ▲▼ to select [IPv4 SETTINGS], and and press the <ENTER> button.
 - The [IPv4 SETTINGS] screen is displayed.
- 8) Press ▲▼ to select an item, and change the setting according to the operation instructions of the menu.

[DHCP]	[ON]	Select this item when using the DHCP server that exists in the network to which the projector is to be connected. IPv4 address is automatically acquired.
	[OFF]	Select this item when setting the IPv4 address manually. Set [IP ADDRESS], [SUBNET MASK], [DEFAULT GATEWAY], [DNS1], and [DNS2].
[IP ADDRESS]	Enter the IP address.	
[SUBNET MASK]	Enter the subnet mask.	
[DEFAULT GATEWAY]	Enter the default gateway address.	
[DNS1]	Enter the preferred DNS server address.	
[DNS2]	Enter the alternate DNS server address.	

- 9) Press ▲▼ to select [OK], and press the <ENTER> button.
 - Setting for the IPv4 address is saved and the [WIRED LAN] screen is displayed.
- 10) Press ▲▼ to select [IPv6 SETTINGS], and and press the <ENTER> button.
 - The [IPv6 SETTINGS] screen is displayed.
- 11) Press ▲▼ to select an item, and change the setting according to the operation instructions of the menu.

[AUTO CONFIGURATION]	[ON]	Select this item when assigning the IPv6 address automatically. Set [TEMPORARY ADDRESS].
	[OFF]	Select this item when setting the IPv6 address manually. Set [IP ADDRESS], [PREFIX LENGTH], [DEFAULT GATEWAY], [DNS1], and [DNS2].
[TEMPORARY ADDRESS]	[ON]	Select this item when the temporary IPv6 address is used.
	[OFF]	Select this item when the temporary IPv6 address is not used.
[IP ADDRESS]	Enter the IP address.	
[PREFIX LENGTH]	[1] - [128]	Select the prefix length. (factory default setting: [64])
[DEFAULT GATEWAY]	Enter the default gateway address.	
[DNS1]	Enter the preferred DNS server address.	
[DNS2]	Enter the alternate DNS server address.	

- 12) After the setting, select [OK] and press the <ENTER> button.

Note

- When using a DHCP server, confirm that the DHCP server is running.
- Consult your network administrator regarding the IP address, subnet mask, default gateway, and prefix length.
- [IPv6] in [IP VERSION] cannot be set in following cases.
 - When the [NETWORK] menu → [NETWORK CONTROL] → [Crestron Connected(TM)] is set to [ON]
- The network setting is common for the <LAN> terminal and the <DIGITAL LINK/LAN> terminal.
- Wired LAN and wireless LAN cannot be used in the same segment.

[PROJECTOR NAME]

You can change the projector name. Enter the host name if it is required to use a DHCP server.

- 1) Press ▲▼ to select [PROJECTOR NAME].
- 2) Press the <ENTER> button.
 - The [PROJECTOR NAME CHANGE] screen is displayed.
- 3) Select characters with the ▲▼◀▶ buttons and press the <ENTER> button to enter the projector name.
 - You can enter up to eight characters.
- 4) After entering the projector name, press ▲▼ to select [OK] and press the <ENTER> button.
 - To cancel, select [CANCEL].

Note

- The factory default setting of the projector name is "Namexxxx". xxxx is a fixed value assigned to each projector.

[NETWORK STATUS]

Displays the network information of the projector.

- 1) Press ▲▼ to select [NETWORK STATUS].
- 2) Press the <ENTER> button.
 - The [NETWORK STATUS] screen is displayed.
- 3) Press ▲▼ to switch the the display screen.
 - The page will change each time you press the button.
[WIRED LAN (IPv4)] (page 1/5), [WIRED LAN (IPv6)] (page 2/5 and 3/5), [WIRELESS LAN] (page 4/5), [Presenter Light] (5/5)

[WIRED LAN (IPv4)]	[DHCP]	Displays the [DHCP] setting.
	[IP ADDRESS]	Displays the [IP ADDRESS].
	[SUBNET MASK]	Displays the [SUBNET MASK].
	[DEFAULT GATEWAY]	Displays the [DEFAULT GATEWAY].
	[DNS1]	Displays the address of the preferred DNS server.
	[DNS2]	Displays the address of the alternate DNS server.
[WIRED LAN (IPv6)]	[MAC ADDRESS]	Displays the [MAC ADDRESS] of wired LAN.
	[AUTO CONFIGURATION]	Displays the [AUTO CONFIGURATION] setting.
	[LINK LOCAL ADDRESS]	Displays [LINK LOCAL ADDRESS] and [PREFIX LENGTH].
	[STATEFUL ADDRESS]	Displays [STATEFUL ADDRESS] and [PREFIX LENGTH].
	[STATELESS ADDRESS]	Displays [STATELESS ADDRESS] and [PREFIX LENGTH].
	[TEMPORARY ADDRESS]	Displays [TEMPORARY ADDRESS] and [PREFIX LENGTH].
	[IP ADDRESS]	Displays [IP ADDRESS] and [PREFIX LENGTH].
	[DEFAULT GATEWAY]	Displays the [DEFAULT GATEWAY].
	[DNS1]	Displays the address of the preferred DNS server.
[DNS2]	Displays the address of the alternate DNS server.	
[WIRED LAN (IPv4)]	[MAC ADDRESS]	Displays the [MAC ADDRESS] of wired LAN.
	[SSID]	Displays the character string of SSID.
[WIRED LAN (IPv6)]	[IP ADDRESS]	Displays the IP address.
[Presenter Light]	[LOGIN PASSWORD]	Displays the login password of Presenter Light.

Note

- There are items that are displayed or not displayed in the [WIRED LAN(IPv6)] page, depending on the setting in the [NETWORK] menu → [WIRED LAN] → [IPv6 SETTINGS] → [AUTO CONFIGURATION].
- The [STATELESS ADDRESS] screen is displayed by pressing the <ENTER> button while [WIRED LAN(IPv6)] (page 2/5) is displayed, and details of the stateless address can be confirmed. Furthermore, the screen will be switched to the [TEMPORARY ADDRESS] screen by pressing ▲▼, and details of the temporary address can be confirmed.
- The [WIRED LAN(IPv4)] page in the [NETWORK STATUS] screen is not displayed when the [NETWORK] menu → [WIRED LAN] → [IP VERSION] is set to [IPv6].
- The [WIRED LAN(IPv6)] page in the [NETWORK STATUS] screen is not displayed when the [NETWORK] menu → [WIRED LAN] → [IP VERSION] is set to [IPv4].
- There is no network setting for the wireless LAN in the projector menu (menu screen). When you attach the optional wireless module (Model No.: AJ-WM50), you can access the projector via the computer for wireless LAN setting. For details, see “Web control function” → [Network config] page → “For wireless LAN connection” (➡ page 133).
- The SSID, IP address (wireless) and QR code are not displayed in [WIRELESS LAN] (page 4/5) in following cases.
 - When the optional wireless module (Model No.: AJ-WM50) is not attached to the <USB (VIEWER/WIRELESS/DC OUT)> terminal
 - When the web control → [Network config] → [WIRELESS LAN] is set to [DISABLE] (➡ page 133)
- A QR code, which makes connection setting with a smartphone easier, is displayed in [WIRELESS LAN] (page 4/5). To directly connect a smartphone to the projector using the QR code, refer to “Using the QR code” (➡ page 122).

[ADMINISTRATOR ACCOUNT]

Set the user name and password of the administrator account.

[PASSWORD POLICY]

Display the policies about the password for the administrator account.

- 1) Press ▲▼ to select [ADMINISTRATOR ACCOUNT].
- 2) Press the <ENTER> button.
 - The [ADMINISTRATOR ACCOUNT] screen is displayed.
- 3) Press ▲▼ to select [PASSWORD POLICY], and press the <ENTER> button.
 - The [PASSWORD POLICY] screen is displayed.

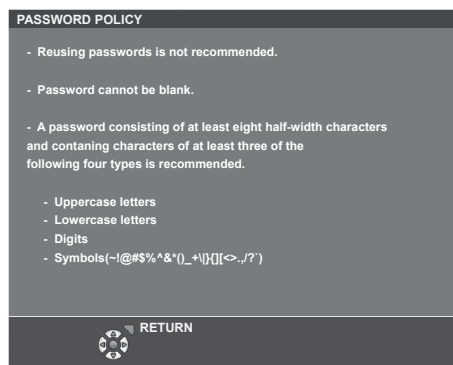

Setting the administrator account for the first time

Set the user name and password of the administrator account.

- 1) Press ▲▼ to select [ADMINISTRATOR ACCOUNT].
- 2) Press the <ENTER> button.
 - The [ADMINISTRATOR ACCOUNT] screen is displayed.
- 3) Press ▲▼ to select [USER NAME], and press the <ENTER> button.
 - The [USER NAME] screen is displayed.
 - The factory default setting of user name is “dispadmin”.
- 4) Press ▲▼◀▶ to select a character, and press the <ENTER> button.
 - Up to 16 characters can be entered.
- 5) After entering the user name, press ▲▼◀▶ to select [OK], and press the <ENTER> button.
 - The [ADMINISTRATOR ACCOUNT] screen is displayed.
- 6) Press ▲▼ to select [PASSWORD], and press the <ENTER> button.
 - The [PASSWORD] screen is displayed.
- 7) Press ▲▼◀▶ to select a character, and press the <ENTER> button.
 - Up to 16 characters can be entered.
 - The password cannot be blank.
- 8) After entering the password, press ▲▼◀▶ to select [OK], and press the <ENTER> button.
 - The [ADMINISTRATOR ACCOUNT] screen is displayed.
- 9) Press ▲▼ to select [PASSWORD CONFIRM], and press the <ENTER> button.
 - The [PASSWORD CONFIRM] screen is displayed.
- 10) Enter the password entered in Step 7).
- 11) After entering the password, press ▲▼◀▶ to select [OK], and press the <ENTER> button.
 - The [ADMINISTRATOR ACCOUNT] screen is displayed.
- 12) Press ▲▼ to select [STORE], and press the <ENTER> button.
 - The confirmation screen is displayed.
- 13) Press ◀▶ to select [OK], and press the <ENTER> button.

Note

- For restrictions on character strings that can be set for password, refer to [PASSWORD POLICY] (➡ page 107).
- If the password of the administrator account has not been set, that is, if it is left blank, the network function of this projector cannot be used. Set a password before using the web control function or the communication control (including operation with application software) via LAN.
- The user name and password of a standard user account without administrator rights can be set on the [Set up password] page (➡ page 139) of the web control screen.

Changing settings of the administrator account

Change the user name and password of the administrator account.

- 1) Press ▲▼ to select [ADMINISTRATOR ACCOUNT].
- 2) Press the <ENTER> button.
 - The [ADMINISTRATOR ACCOUNT] screen is displayed.
- 3) Press ▲▼ to select [USER NAME] under [CURRENT], and press the <ENTER> button.
 - The [USER NAME] screen is displayed.
- 4) Press ▲▼◀▶ to select a character, and press the <ENTER> button.
 - Enter the current user name.
- 5) After entering the user name, press ▲▼◀▶ to select [OK], and press the <ENTER> button.
 - The [ADMINISTRATOR ACCOUNT] screen is displayed.
- 6) Press ▲▼ to select [PASSWORD] under [CURRENT], and press the <ENTER> button.
 - The [PASSWORD] screen is displayed.
- 7) Press ▲▼◀▶ to select a character, and press the <ENTER> button.
 - Enter the current password.
- 8) After entering the password, press ▲▼◀▶ to select [OK], and press the <ENTER> button.
 - The [ADMINISTRATOR ACCOUNT] screen is displayed.
- 9) Press ▲▼ to select [USER NAME] under [NEW], and press the <ENTER> button.
 - The [USER NAME] screen is displayed.
- 10) Press ▲▼◀▶ to select a character, and press the <ENTER> button.
 - Enter a new user name.
 - Enter the current user name if you do not want to change it.
 - Up to 16 characters can be entered.
- 11) After entering the user name, press ▲▼◀▶ to select [OK], and press the <ENTER> button.
 - The [ADMINISTRATOR ACCOUNT] screen is displayed.
- 12) Press ▲▼ to select [PASSWORD] under [NEW], and press the <ENTER> button.
 - The [PASSWORD] screen is displayed.
- 13) Press ▲▼◀▶ to select a character, and press the <ENTER> button.
 - Enter a new password.
 - Up to 16 characters can be entered.
 - Enter the current password if you do not want to change it.
- 14) After entering the password, press ▲▼◀▶ to select [OK], and press the <ENTER> button.
 - The [ADMINISTRATOR ACCOUNT] screen is displayed.
- 15) Press ▲▼ to select [PASSWORD CONFIRM] under [NEW], and press the <ENTER> button.
 - The [PASSWORD CONFIRM] screen is displayed.
- 16) Enter the password entered in Step 13).
- 17) After entering the password, press ▲▼◀▶ to select [OK], and press the <ENTER> button.
 - The [ADMINISTRATOR ACCOUNT] screen is displayed.
- 18) Press ▲▼ to select [STORE], and press the <ENTER> button.
 - The confirmation screen is displayed.
- 19) Press ◀▶ to select [OK], and press the <ENTER> button.

Note

- For restrictions on character strings that can be set for password, refer to [PASSWORD POLICY] (➔ page 107).
- The user name and password of the administrator account can also be changed on the [Set up password] page (➔ page 139) of the web control screen.
- The user name and password of a standard user account without administrator rights can be set on the [Set up password] page (➔ page 139) of the web control screen.

[NETWORK SECURITY]

Make settings to protect the projector from external attacks via LAN and unauthorized use.

Setting the password of the administrator account (➔ page 107) is required for setting the [NETWORK SECURITY] menu.

[COMMAND PROTECT]

Make settings for the connection authentication when using the command control function.

- 1) Press ▲▼ to select [NETWORK SECURITY].
- 2) Press the <ENTER> button.
 - The [NETWORK SECURITY] screen is displayed.
- 3) Press ◀▶ to switch the [COMMAND PROTECT] setting.

[ENABLE]	Connect to the projector in protected mode. The user name and password of the administrator account are required for the connection authentication.
[DISABLE]	Connect to the projector in non-protected mode. Connection authentication is not performed.

- The confirmation screen is displayed once the setting is switched.
- 4) Press ◀▶ to select [OK], and press the <ENTER> button.
 - The [COMMAND PROTECT] screen is displayed.
 - 5) Press ▲▼ to select [PASSWORD], and press the <ENTER> button.
 - The [PASSWORD] screen is displayed.
 - 6) Press ▲▼◀▶ to select a character, and press the <ENTER> button.
 - Enter the password of the administrator account.
 - 7) After entering the password, press ▲▼◀▶ to select [OK], and press the <ENTER> button.
 - The [COMMAND PROTECT] screen is displayed.
 - 8) Press ▲▼◀▶ to select [OK], and press the <ENTER> button.

Note

- When [COMMAND PROTECT] is set to [DISABLE], connection authentication is not performed, making it vulnerable to threats on the network. Be aware of the risks before making settings.
- For details on how to use the command control function, refer to “Control commands via LAN”. (➔ page 157)

[NETWORK CONTROL]

Set the network control of this projector.

Setting the password of the administrator account (➔ page 107) is required for using the network function of the projector.

- 1) Press ▲▼ to select [NETWORK CONTROL].
- 2) Press the <ENTER> button.
 - The [NETWORK CONTROL] screen is displayed.
- 3) Press ▲▼ to select an item and press ◀▶ to change the setting.

[WEB CONTROL]	Set to [ON] to control with the web browser.
[COMMAND CONTROL]	Set to [ON] to control with the <SERIAL IN> terminal control command format (➔ page 160). Refer to “Control commands via LAN” (➔ page 157).
[COMMAND PORT]	Set the port number used for command control.
[Crestron Connected(TM)]	Set to [ON] to control with Crestron Connected of Crestron Electronics, Inc.
[AMX D. D.]	Set to [ON] to control with the controller of AMX Corporation. Setting this function to [ON] enables detection through “AMX Device Discovery”. For details, visit the website of AMX Corporation. URL http://www.amx.com/

4) Press ▲▼ to select [OK] and press the <ENTER> button.

Note

- If the password of the administrator account has not been set, that is, if it is left blank, the network function of this projector cannot be used. Set a password before using the web control function or the communication control (including operation with application software) via LAN.
- [Crestron Connected(TM)] cannot be set when the [NETWORK] menu → [WIRED LAN] → [IP VERSION] is set to [IPv6].

[PJLink]

Set the PJLink function to control and monitor the projector using the PJLink protocol.

Setting the password of the administrator account (➔ page 107) is required for using the PJLink function of the projector.

Note

- If the password of the administrator account has not been set, that is, if it is left blank, the network function of this projector cannot be used. Set a password before using the web control function or the communication control (including operation with application software) via LAN.

[PJLink PASSWORD]

Set the password for security authentication which is required when connecting to the projector.

- 1) Press ▲▼ to select [PJLink].
- 2) Press the <ENTER> button.
 - The [PJLink] screen is displayed.
- 3) Press ▲▼ to select [PJLink PASSWORD], and press the <ENTER> button.
 - The [PJLink PASSWORD] screen is displayed.
- 4) Press ▲▼ to select [PASSWORD] under [CURRENT], and press the <ENTER> button.
 - The [PASSWORD] screen is displayed.
- 5) Press ▲▼◀▶ to select a character, and press the <ENTER> button.
 - Enter the current password.
 - The factory default setting of password is blank.
- 6) After entering the password, press ▲▼◀▶ to select [OK], and press the <ENTER> button.
 - The [PJLink PASSWORD] screen is displayed.
- 7) Press ▲▼ to select [PASSWORD] under [NEW], and press the <ENTER> button.
 - The [PASSWORD] screen is displayed.
- 8) Press ▲▼◀▶ to select a character, and press the <ENTER> button.
 - Enter a new password.
 - Up to 32 alphanumeric characters can be entered.
- 9) After entering the password, press ▲▼◀▶ to select [OK], and press the <ENTER> button.
 - The [PJLink PASSWORD] screen is displayed.
- 10) Press ▲▼ to select [PASSWORD CONFIRM], and press the <ENTER> button.
 - The [PASSWORD CONFIRM] screen is displayed.
- 11) Enter the password entered in Step 8).
- 12) After entering the password, press ▲▼◀▶ to select [OK], and press the <ENTER> button.
 - The [PJLink PASSWORD] screen is displayed.
- 13) Press ▲▼ to select [STORE], and press the <ENTER> button.
 - The confirmation screen is displayed.
- 14) Press ◀▶ to select [OK], and press the <ENTER> button.

Note

- The PJLink password can also be changed on the [Set up password] page (➔ page 139) of the web control screen.

[PJLink CONTROL]

Set to enable or disable the PJLink protocol control function.

- 1) Press ▲▼ to select [PJLink].
- 2) Press the <ENTER> button.
 - The [PJLink] screen is displayed.
- 3) Press ▲▼ to select [PJLink CONTROL].
- 4) Press ◀▶ to switch the item.
 - The items will switch each time you press the button.

[ON]	Enables PJLink protocol control function.
[OFF]	Disables PJLink protocol control function.

[PJLink NOTIFICATION]

Set to enable or disable the PJLink notification function.

- 1) Press ▲▼ to select [PJLink].
- 2) Press the <ENTER> button.
 - The [PJLink] screen is displayed.
- 3) Press ▲▼ to select [PJLink NOTIFICATION].
- 4) Press ◀▶ to switch the item.
 - The items will switch each time you press the button.

[OFF]	Disables the PJLink notification function.
[ON]	Enables the PJLink notification function.

- If [ON] is selected, proceed to Step 5).

- 5) Press ▲▼ to select [NOTIFIED IP ADDRESS 1], [NOTIFIED IP ADDRESS 2], [NOTIFIED IP ADDRESS 1(IPv6)], or [NOTIFIED IP ADDRESS 2(IPv6)], and press the <ENTER> button.
 - The [NOTIFIED IP ADDRESS 1] screen, the [NOTIFIED IP ADDRESS 2] screen, the [NOTIFIED IP ADDRESS 1(IPv6)] screen or the [NOTIFIED IP ADDRESS 2(IPv6)] screen is displayed.
 - Enter the IP address of the computer to notify the status of the projector.
- 6) After entering the IP address, press ▲▼◀▶ to select [OK], and press the <ENTER> button.

[MEMORY VIEWER]

Set the operations of the Memory Viewer function.

Note

- The [MEMORY VIEWER] menu can be operated and set only when MEMORY VIEWER input is selected.
- For details on how to use the memory viewer function, please refer to “Projecting with MEMORY VIEWER input” (➔ page 116).

[SET SLIDE]

Start the slideshow. For details on the slideshow, see “Executing the slide” (➔ page 117).

[SLIDE TRANSITION EFFECT]

Sets the transition effects when switching the slides playback.

- 1) Press ▲▼ to select [SLIDE TRANSITION EFFECT].
- 2) Press ◀▶ to switch the item.
 - The items will switch each time you press the button.

[SLIDE RIGHT]	The slides switch from left to right.
[SLIDE DOWN]	The slides switch from top to bottom.

- 3) Press ▲▼ to select [APPLY].
- 4) Press the <ENTER> button.
 - The setting will be effective.

[SORT ORDER]

Sets the order of images to be played in the slideshow.

- 1) Press ▲▼ to select [SORT ORDER].
- 2) Press ◀▶ to switch the item.
 - The items will switch each time you press the button.

[NAME ORDER]	Displays the files or folders in ascending order of their names.
[TIME ORDER]	Displays the files or folders in the order of their modification date and time.
[SIZE ORDER]	Displays the files or folders in ascending order of their data size.
[EXTEND ORDER]	Displays the files in ascending order of their extensions.

- 3) Press ▲▼ to select [APPLY].
- 4) Press the <ENTER> button.
 - The setting will be effective.

[ROTATE]

Sets the rotational direction of the images.

- 1) Press ▲▼ to select [ROTATE].
- 2) Press ◀▶ to switch the item.
 - The items will switch each time you press the button.

[NO ROTATE]	Rotation is disabled.
[90 DEGREE]	Rotate 90 degrees clockwise.
[180 DEGREE]	Rotate 180 degrees clockwise.
[270 DEGREE]	Rotate 270 degrees clockwise (90 degrees counterclockwise).

- 3) Press ▲▼ to select [APPLY].
- 4) Press the <ENTER> button.
 - The setting will be effective.

[BEST FIT]

Sets whether to fit the image to the projection screen.

- 1) Press ▲▼ to select [BEST FIT].
- 2) Press ◀▶ to switch the item.
 - The items will switch each time you press the button.

[OFF]	Displays the image in its original pixels.
[ON]	Displays the image according to the screen set in the [DISPLAY OPTION] menu → [SCREEN SETTING].

- 3) Press ▲▼ to select [APPLY].
- 4) Press the <ENTER> button.
 - The setting will be effective.

[REPEAT]

Sets whether to loop the slideshow.

- 1) Press ▲▼ to select [REPEAT].

2) Press ◀▶ to switch the item.

- The items will switch each time you press the button.

[OFF]	After playing the last file, exit the slideshow and return to the thumbnail display.
[ON]	After playing the last file, return to the first file and repeat playback.

3) Press ▲▼ to select [APPLY].

4) Press the <ENTER> button.

- The setting will be effective.

[INITIALIZE]

This function is used to return various setting values of [NETWORK] to the factory default value.

1) Press ▲▼ to select [INITIALIZE].

2) Press the <ENTER> button.

3) When the [INITIALIZE] screen is displayed, press ◀▶ to select [OK] and then press the <ENTER> button.

Note

- If the [SECURITY] menu → [PASSWORD] is set to [ON], the [PASSWORD] screen will be displayed when [INITIALIZE] is selected and the <ENTER> button is pressed. Continue your operation after entering the security password set for the projector.
- When [INITIALIZE] is executed, the [ADMINISTRATOR ACCOUNT] screen is displayed when the projection starts next time.

Chapter 5 Operation of Function

This chapter describes the operation methods of some functions.

Projecting with MEMORY VIEWER input

The Memory Viewer function makes it possible to display the still images stored in the USB memory as projected images.

What you can project with the Memory Viewer function

Memory Viewer function supports the following image files.

	Extension	Format	Description
Picture	jpg/jpeg	Baseline coding 24 bits Progressive RGB 24 bits	Resolution : 8 x 8 ~ 10 000 x 10 000 Resolution : 8 x 8 ~ 1 920 x 1 200
	bmp	Palette-based 1, 4, 8 bits, RGB 24, 32 bits	The maximum resolution : 1 920 x 1 200
	png	True color 24 bits/48 bits	The maximum resolution : 1 920 x 1 200
	gif	Palette-based 1, 4, 8 bits,	Palette - 24 bits color spaces; The maximum resolution : 1 920 x 1 200
	tif / tiff	—	The maximum resolution : 1 920 x 1 200

Note

- File size that can be played back is 2 GB at the maximum.
- The total number of folders/files that can be recognized on the projector is 1 000 at the maximum.
- Files protected by DRM (Digital Rights Management) cannot be played back.
- It maybe impossible to play even if the file is recorded in the supported format.

Cautions on using USB Memory

Please observe the following.

- Do not put USB memory or its cap within close reach of children. Swallowing them may cause suffocation.
- If the smoke or questionable odor rise, remove the USB memory from the projector, and then contact your dealer.
- Do not put water, chemical or oil to the USB memory. It may cause short out or fire.
- Do not put foreign objects or put metal objects to the USB terminal. It may cause data loss or data corruption.
- Do not remove the USB memory from the projector while data is being read from the USB memory. It may cause data loss or data corruption.
- Do not leave the USB memory in a place with high humidity or dust.
- Do not leave the USB memory in a place where static electricity or electromagnetic radiation is generated.

Note

- It is compatible with the USB memory sold in the market.
- It cannot be used the other format other than the formatted with FAT16 and FAT32.

Attaching the USB memory

- 1) Attach the USB memory firmly into the <USB (VIEWER/WIRELESS/DC OUT)> terminal.

Attention

- Pay attention to the terminal direction to avoid damaging the terminal when attaching the USB memory.
- Attach the USB memory directly into the <USB (VIEWER/WIRELESS/DC OUT)> terminal of the projector. Do not use a USB extension cable or USB hub.

Removing the USB memory

- 1) Make sure that the indicator on the USB memory is not flashing, and remove it.

Attention

- Please note following points when removing the USB memory.
 - When the indicator of the USB memory attached to the projector is blinking, it indicates that the projector is reading the USB memory. Do not remove the USB memory from the projector while the indicator is blinking.
 - When using a USB memory that does not have a monitor function such as an indicator, you cannot check the access status to the USB memory. In this case, remove it from the projector after closing the Memory Viewer function or turning off the projector.
 - Do not attach and detach the USB memory in a short time. Wait at least 5 seconds after attaching and then remove the USB memory. If you want to reattach it, wait at least 5 seconds after removal. It takes about 5 seconds for the projector to recognize the USB memory.

Displaying the Memory Viewer screen

- 1) Press the <NETWORK/USB> button on the remote control to switch the input source to MEMORY VIEWER.
 - You can also press the <INPUT SELECT> button on the control panel and select the input source in the Input menu.
- 2) Attach the USB memory directly into the <USB (VIEWER/WIRELESS/DC OUT)> terminal.
 - The standby screen “please press ENTER” is displayed while the USB memory icon is displayed at the lower left of the screen.
- 3) Press the <ENTER> button on the remote control.
 - The root directory of the USB memory will be displayed in thumbnail on the screen.

Playing the pictures

- 1) Press ▲▼◀▶ on the remote control to select a file you want to play on the memory viewer screen.
- 2) Press the <ENTER> button on the remote control.
 - The picture will display on the full screen.
- 3) Press ▶ to switch to the next picture, press ◀ to return to the previous picture.
- 4) Press the <ENTER> button on the remote control.
 - Return to the thumbnail screen.

Note

- When the recorded number of pixels is smaller than the maximum number of display dot *1, it will be displayed enlarged maintaining the aspect ratio.
- When the recorded number of pixels is larger than the maximum number of display dot *1, it will be displayed reduced maintaining the aspect ratio.
- When the recorded number of pixels is the same as the maximum number of display dot *1, it will neither be enlarged nor reduced, so degradation of image quality can be reduced.

*1 The maximum number of display dot for each product is as follows.

PT-VMZ71, PT-VMZ61, PT-VMZ51, PT-VMZ51S, PT-VMZ41: 1 920 x 1 200

PT-VMW61, PT-VMW51: 1 280 x 800

Executing the slide

All pictures in the same folder will play automatically according to the settings of [SORT ORDER], [SLIDE TRANSITION EFFECT] and so on of the [MEMORY VIEWER] menu.

- 1) Press ▲▼◀▶ on the remote control to select a file.
- 2) Press the <MENU> button to select the [MEMORY VIEWER] → [SET SLIDE].
- 3) Press the <ENTER> button on the remote control.
 - The slideshow will start.
 - Press the <ENTER> button to return to the thumbnail screen.

Note

- If you press the <MENU> button during playback in the slideshow, the playback will stop and the a menu displays. The playing will continue when the menu disappears.

Termination of the Memory Viewer

- 1) Press ▲▼◀▶ to select the thumbnail  which is displayed on the upper left corner.
- 2) Press the <ENTER> button on the remote control.
 - Return to the standby screen “please press ENTER”.Depending on file path length, you may need to repeat Step 1) and Step 2) before returning to the standby screen.

Note

- You can also exit the Memory Viewer by switching to the input other than MEMORY VIEWER.

Projecting with NETWORK input

Using the Panasonic application, the image sent from a device connected via LAN can be displayed as a projected image.

The wireless module (Model No.: AJ-WM50) of the optional accessories is required if you want to use the network function through the wireless LAN.

Application that can be used

The image transfer application software used for NETWORK input are as follows.

- Presenter Light (for Windows)
- Wireless Projector for iOS, Wireless Projector for Android

Note

- For details of the image transfer application software of Presenter Light and Wireless Projector, refer to the website: <https://panasonic.net/cns/projector/>.

Connecting the device

- 1) **Press the <NETWORK/USB> button to switch the input to NETWORK.**
 - Every time the <NETWORK/USB> button is pressed, the input will switch between MEMORY VIEWER and NETWORK.
 - The standby screen is displayed once the input is switched to NETWORK.
- 2) **Connect the device with the image transfer application software started to the projector.**
 - The image sent to the projector by the operation on the device is displayed as the projected image.

Note

- For details of the connection method to the projector using the application software, refer to the Operation Instruction of each application software.
- For details of the NETWORK input idle screen, refer to "Connecting with wireless LAN" (➔ page 121).

Ending the connection with the device

- 1) **Perform disconnection process in the device side.**
 - Once the connection is disconnected, the standby screen is displayed.

Note

- It may take some time for the standby screen to display when the connection is ended forcefully by turning off the device, etc., without performing an appropriate disconnection process.

Network connection

This projector has network function that allows the following by connecting a computer.

- **Web control**

By accessing to the projector from a computer, you can perform setting, adjustment, status display, etc. of the projector. Refer to “Web control function” (➡ page 126) for details.

- **Multi Monitoring & Control software**

“Multi Monitoring & Control Software”, a software application to monitor and control multiple display devices (projector or flat panel display) connected to intranet, can be used.

Plug-in software “Early Warning Software”, which monitors the status of the display devices and their peripherals within an intranet, and notifies of abnormality of such equipment and detects the signs of possible abnormality, can also be used.

For details, visit the website (<https://panasonic.net/cns/projector/>).

- **Image transfer application software**

Using the Panasonic image transfer application software, the image sent from a device can be displayed as a projected image.

For details on how to use the image transfer application software “Presenter Light” compatible with Windows computers, please refer to the Operating Instructions of “Presenter Light Software”. “Presenter Light Software” can be downloaded by accessing the projector via a web browser. For details, please refer to “About Presenter Light” (➡ page 125). The application software and its operating instructions can be downloaded from the website (<https://panasonic.net/cns/projector/>).

For details of the image transfer application software “Wireless Projector” compatible with the iPad/iPhone/iPod touch or Android device, refer to the website (<https://panasonic.net/cns/projector/>).

- **PJLink**

By using PJLink protocol, you can send inquiries about the operations or status of the projector from a computer. Refer to “Using the PJLink function” (➡ page 155) for details.

- **Command control**

Operation or status query of the projector can be performed from a computer with the control commands. Refer to “Control commands via LAN” (➡ page 157) for details.

Note

- Setting the password of the administrator account (➡ page 107) is required for using the network function of the projector. If the password of the administrator account has not been set, that is, if it is left blank, the network function of this projector cannot be used. Set a password before using the web control function or the communication control (including operation with application software) via LAN.

Connecting via wired LAN

This projector can receive the Ethernet signal from the twisted-pair-cable transmitter via a LAN cable.

Example of a general network connection

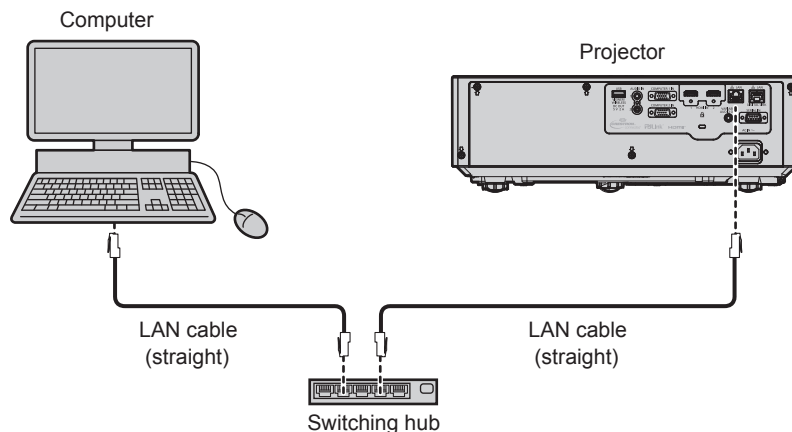

Attention

- When a LAN cable is directly connected to the projector, cabling must be made indoors.

Note

- A LAN cable is required to use the wired LAN function.
- Use a straight or crossover LAN cable that is compatible with CAT5 or higher. Either the straight or the crossover cable, or both cables can be used depending on the system configuration, check with your network administrator. The projector identifies the type of the cable (straight or crossover) automatically.
- Use a LAN cable of 100 m (328'1") or shorter.

Example of network connections via a twisted-pair-cable transmitter

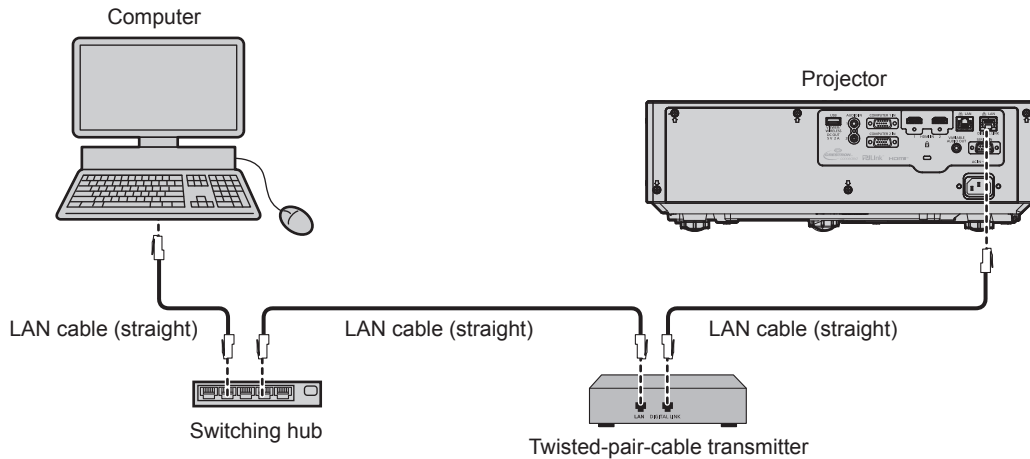

Attention

- When a LAN cable is directly connected to the projector, cabling must be made indoors.

Note

- For the LAN cable between a twisted-pair-cable transmitter and the projector, use a cable that meets the following criteria:
 - Compatible with CAT5e or higher
 - Shielded type (including connectors)
 - Straight-through
 - Single wire
 - Diameter of the cable core is same or larger than AWG24 (AWG24, AWG23, etc.)
- The maximum transmission distance between the twisted-pair-cable transmitter and the projector is 100 m (328'1") for the signal with resolution of 1 920 x 1 200 dots or less. For the signal with the resolution exceeding 1 920 x 1 200 dots, the maximum transmission distance is 50 m (164'1"). It is possible to transmit up to 150 m (492'2") if the twisted-pair-cable transmitter supports the long-reach communication method. However, the signal that the projector can receive is only up to 1080/60p (1 920 x 1 080 dots, dot clock frequency 148.5 MHz) for the long-reach communication method. If these distances are exceeded, image may be disrupted or a malfunction may occur in LAN communication.
- When laying cables between a twisted-pair-cable transmitter and the projector, check that cable characteristics are compatible with CAT5e or higher using tools such as a cable tester or cable analyzer.
When using a relay connector midway, include it in the measurement.
- Do not use a switching hub between a twisted-pair-cable transmitter and the projector.
- To transmit the Ethernet and serial control signals using the <DIGITAL LINK/LAN> terminal, set the [NETWORK] menu → [ETHERNET TYPE] to [DIGITAL LINK] or [LAN & DIGITAL LINK].
- To transmit the Ethernet signal using the <LAN> terminal, set the [NETWORK] menu → [ETHERNET TYPE] to [LAN] or [LAN & DIGITAL LINK].
- The <DIGITAL LINK/LAN> terminal and the <LAN> terminal are connected inside of the projector when the [NETWORK] menu → [ETHERNET TYPE] is set to [LAN & DIGITAL LINK]. Do not directly connect the <DIGITAL LINK/LAN> terminal and the <LAN> terminal using a LAN cable. Construct the system so that it is not connected to the same network via the peripherals such as the switching hub or the twisted-pair-cable transmitter.
- Do not pull cables forcefully. Also, do not bend or fold cables unnecessarily.
- To reduce the effects of noise as much as possible, stretch out the cables between the twisted-pair-cable transmitter and the projector without any loops.
- Lay the cables between a twisted-pair-cable transmitter and the projector away from other cables, particularly power cables.
- When installing multiple cables, run them side by side along the shortest distance possible without bundling them together.
- After laying the cable, confirm that the value of [SIGNAL QUALITY] in the [NETWORK] menu → [DIGITAL LINK] → [DIGITAL LINK STATUS] is displayed in green, which indicates a normal quality.
- For twisted-pair-cable transmitter of other manufacturers of which the operation has been verified with the DIGITAL LINK compatible projector, refer to website (<https://panasonic.net/cns/projector/>). Note that the verification for devices of other manufacturers has been made for the items set by Panasonic Connect Co., Ltd., and not all the operations have been verified. For operation or performance problems caused by the devices of other manufacturers, contact the respective manufacturers.

Projector settings

- 1) Connect the projector to a computer using a LAN cable.
- 2) Turn on the power of the projector.
- 3) Select the [NETWORK] menu → [WIRED LAN] from the main menu and press the <ENTER> button.

4) Perform the detailed setting of [WIRED LAN].

- For details, Refer to “[WIRED LAN]” (➔ page 105).

Note

- To connect to an existing network, perform after consulting your network administrator.

■ **Factory default setting**

- Following setting has been made as a factory default.

[DHCP]	OFF
[IP ADDRESS]	192.168.10.100
[SUBNET MASK]	255.255.255.0
[DEFAULT GATEWAY]	192.168.10.1
[DNS1] / [DNS2]	None

Operating the computer

1) Turn on the power of the computer.

2) Perform the network setting following the instruction of your network administrator.

- If the projector is in factory default setting, you can use it as it is if the network setting of the computer is as follows.

[IP ADDRESS]	192.168.10.101
[SUBNET MASK]	255.255.255.0
[DEFAULT GATEWAY]	192.168.10.1

Connecting with wireless LAN

The wireless module (Model No.: AJ-WM50) of the optional accessories is required if you want to use the network function through the wireless LAN.

Connection example

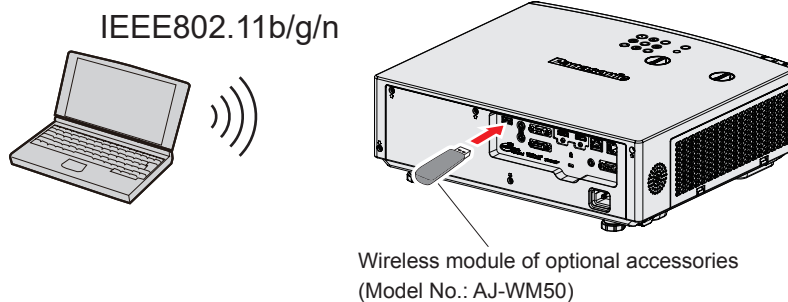

Preparation and confirmation of the projector

1) Turn on the projector.

2) Attach the wireless module (Model No.: AJ-WM50) of optional accessories firmly into the <USB (VIEWER/WIRELESS/DC OUT)> terminal.

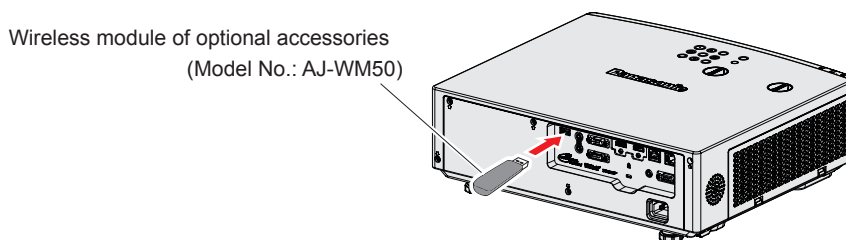

3) Press the <NETWORK/USB> button to switch to NETWORK input.

- The network input idle screen is displayed. The QR code, login password (a four-digit number that is automatically generated), PROJECTOR NAME, SSID, IP ADDRESS (WIRELESS) and IP ADDRESS (WIRED) will be displayed in the idle screen.

- You can also press the <INPUT SELECT> button on the control panel and the input guide is displayed, then press ▲▼◀▶ to switch to NETWORK input.

Network input idle screen

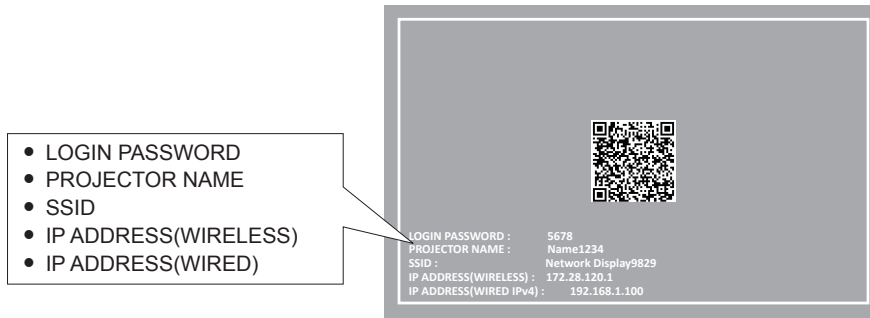

Attention

- Please do not move or transport the projector while the wireless module is attached. Doing so may cause the wireless module to be damaged.
- The indicator of the wireless module will be off when the projector is in standby mode, it will light blue when the power is turned on and it will blink blue during wireless communication. Please do not remove the wireless module while the indicator is blinking.
- When the power of the projector is turned on and the indicator of the wireless module is not lighting/blinking, please insert the wireless module to the <USB (VIEWER/WIRELESS/DC OUT)> terminal again.
- After turning on the projector, please connect network to the projector after the IP ADDRESS (WIRELESS LAN) is displayed.

Note

- A QR code, which makes connection setting with a smartphone easier, is displayed in the network input idle screen. To directly connect a smartphone to the projector using the QR code, refer to “Using the QR code” (► page 122).
- The IPv4 address of wired LAN in network input idle screen is not displayed when the [NETWORK] menu → [WIRED LAN] → [IP VERSION] is set to [IPv6].
- Wireless LAN and wired LAN cannot be used in the same segment.
- The settings of the wireless module are as follows. You can access the projector from the web browser to set the values of [SSID], [CHANNEL] and [KEY].

[SSID]	Network Displayxxxx (xxxx is a fixed value assigned to each projector.)
[CHANNEL]	1
[IP ADDRESS]	172.28.120.1
[SUBNET MASK]	255.255.255.0
[DEFAULT GATEWAY]	0.0.0.0
[ENCRYPTION]	WPA2-PSK(AES)
[KEY]	panasonic

Computer setting

- Turn on the computer.**
- Make the network setting according to your system administrator.**
 - Please make the network settings for the computer and the projector according to your system administrator.
- Connect to the network that has been set in the projector.**
 - If you use a computer, click on the task tray  (bottom right of the computer), select the same name as the [SSID] that has been set in the projector and enter the password for wireless connection.
 - The default factory password for wireless connection is “panasonic”.

Note

- If you use any wireless LAN connection utility that meets the OS standard, follow the operation instruction of the utility to connect it.

Using the QR code

A smartphone can be connected to the projector via wireless LAN just by reading the QR code that the projector displays with the camera on a smartphone.

■ Compatible devices

iPhone: iOS 11 or later

Android devices: Android 7.0 or later

Note

- A device supporting reading of a QR code and application software of the camera supporting reading of a QR code are required.
- For the devices that the operation has been verified with this projector, visit the website (<https://panasonic.net/cns/projector/>). Note that the verification for devices of other manufacturers has been made for the items set by Panasonic Connect Co., Ltd., and not all the operations have been verified. For operation or performance problems caused by the devices of other manufacturers, contact the respective manufacturers.
- The QR code cannot be used for connecting the application software "Wireless Projector" to the projector.

■ Displaying the QR code in OSD

The following is the operation of the projector when reading the QR code displayed in the on-screen menu (OSD).

- 1) Press the <MENU> button to open the [NETWORK] menu from the main menu.
 - The [NETWORK] screen is displayed.
- 2) Press ▲▼ to select [NETWORK STATUS], and press the <ENTER> button.
 - The [NETWORK STATUS] screen is displayed.
- 3) Press ▲▼ to switch the displayed screen and display [WIRELESS LAN] (page 4/5).
 - The QR code is displayed.

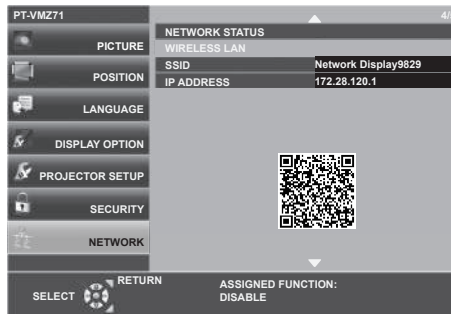

Note

- The SSID, IP address (wireless) and QR code are not displayed in following cases.
 - When the optional wireless module (Model No.: AJ-WM50) is not attached to the <USB (VIEWER/WIRELESS/DC OUT)> terminal
 - When the web control → [Network config] → [WIRELESS LAN] is set to [DISABLE] (➡ page 133)

■ Displaying the QR code in the network input idle screen

The following is the operation of the projector when reading the QR code displayed in the network input idle screen.

- 1) Press the <NETWORK/USB> button to switch to NETWORK input.
 - You can also press the <INPUT SELECT> button on the control panel and the input guide is displayed, then press ▲▼◀▶ to switch to NETWORK input.
 - The QR code is displayed.

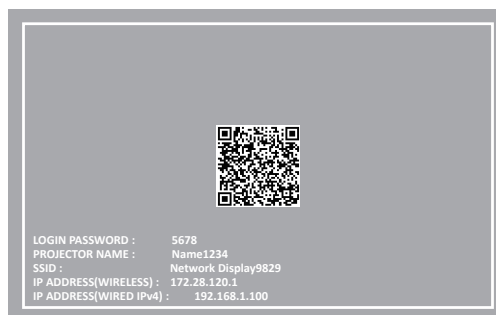

Note

- The SSID, IP address (wireless) and QR code are not displayed in following cases.
 - When the optional wireless module (Model No.: AJ-WM50) is not attached to the <USB (VIEWER/WIRELESS/DC OUT)> terminal
 - When the web control → [Network config] → [WIRELESS LAN] is set to [DISABLE] (➡ page 133)

■ **Operation of a smartphone**

- 1) **Start application software of the camera supporting reading of a QR code.**
- 2) **Read the QR code displayed in the OSD or the network input idle screen with the camera.**
- 3) **Tap the notification displayed on the smartphone screen.**
 - Tap “Join” or “Connect” if a message to confirm the connection is displayed.
 - The smartphone will be connected to the projector via wireless LAN.

About Presenter Light

The wireless module (Model No.: AJ-WM50) of the optional accessories is required if you want to use the network function through the wireless LAN.

By using image transfer application software “Presenter Light Software” that supports Windows computers, you can transfer images and audio to the projector via the wired LAN or wireless LAN*1.

*1 Sound interruption or noise may occur during image / sound transfer. In such a case, please select mute in the audio setting of the application software.

Note

- For wired LAN connection, Presenter Light Software can not be used when [NETWORK] menu → [WIRED LAN] → [IP VERSION] is set to [IPv6].

Download the “Presenter Light” to your computer

- 1) **Access the projector from the web browser on the computer.**
 - For information on accessing from the web browser, refer to “Accessing from the web browser” (➔ page 126).
- 2) **Click [Download].**
 - The download screen of “Presenter Light” is displayed.

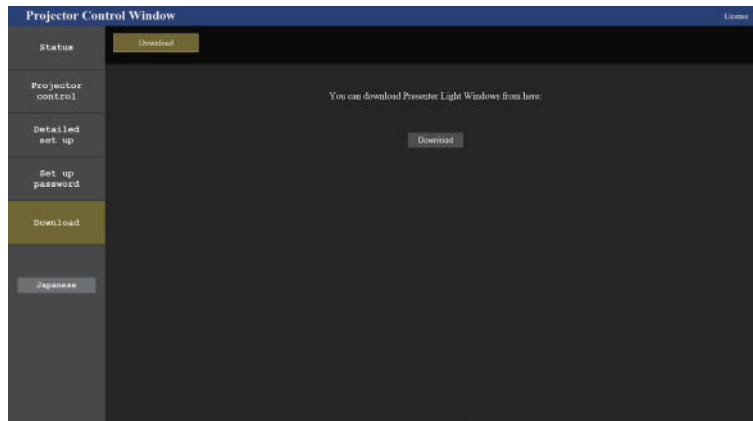

- 3) **Click [Download].**
 - The download confirmation screen of the compressed file “Presenter Light.zip” is displayed.
- 4) **Save and decompress “Presenter Light.zip”.**
 - After decompressing, a “Presenter Light” folder, which contains an executable file “Presenter Light.exe” and a “License” folder with the open source licenses used for the “Presenter Light” software, is generated.
 - Execute “Presenter Light.exe” directly when using the Presenter Light software. Please save this software or make a shortcut for convenient use. Installing the software on the computer is unnecessary.

Note

- To learn more about how to use the “Presenter Light” software, or download the latest versions of the “Presenter Light” software, please visit the website (<https://panasonic.net/cns/projector/>)

Web control function

The wireless module (Model No.: AJ-WM50) of the optional accessories is required if you want to use the network function through the wireless LAN.

Using Web control functions, you can perform the following operations from a computer.

- Setting and adjustment of the projector
- Displaying projector status
- Sending E-mail messages when there is a problem with the projector

The projector supports “Crestron Connected”, and the following application software of Crestron Electronics, Inc. can be used.

- RoomView Express
- Crestron Fusion

Note

- Communication with an E-mail server is required to use the E-mail function. Confirm that the E-mail can be used beforehand.
- “Crestron Connected” is a system of Crestron Electronics, Inc. that collectively manages and controls devices on multiple systems connected to a network using a computer.
- For details of “Crestron Connected”, refer to the website of Crestron Electronics, Inc.

URL <https://www.crestron.com>

To download “RoomView Express”, go to the website of Crestron Electronics, Inc.

URL <https://www.crestron.com/resources/get-roomview>

Computer that can be used for setting

A web browser is required to use the web control function. Confirm that your web browser can be used beforehand.

OS	Compatible web browser
Windows	Internet Explorer 11.0 Microsoft Edge
Mac OS	Safari 11.0/12.0/13.0/14.0/15.0
iOS	Safari (version equipped with iOS11, iOS12, iOS13, iOS14 or iOS15)
Android	Google Chrome (version equipped with Android 7.0/8.0/9.0/10.0/11.0/12.0)

Accessing from the web browser

- 1) Start up the web browser on the computer.
- 2) Enter the IP address set on the projector into the URL entry field of the web browser.
 - If the user name and password of the administrator account have been set on the initial setting screen (➔ page 49) or in the [NETWORK] menu → [ADMINISTRATOR ACCOUNT] (➔ page 107), proceed to Step 7).
 - The [Set up password] page is displayed if the administrator account has not been set.

Projector Control Window Logout

Set up password

Please input user name and password.

Account: Administrator

New

User name:

Password:

Password(Retyping):

- Keeping passwords is not recommended.
- Password cannot be blank.
- A password consisting of at least eight half-width characters and containing characters of at least three of the following five types is recommended.
 - Uppercase letters
 - Lowercase letters
 - Digits
 - Symbols (-!@#%&*()_~|[]{}~?)
- The user name and password are used by the Web Control function and for communication control via a LAN (including Panasonic application software).

Changing the current settings may interrupt the connection. For details, refer to the user's manual.

- 3) In [User name], enter the user name of the administrator account.
 - The factory default setting of user name is “dispadmin”.
- 4) In [Password], enter the password of the administrator account.

- The password cannot be blank.
- A password consisting of at least eight single-byte characters is recommended.
- A password consisting of at least three of the following four character types is recommended.
 - Uppercase letters
 - Lowercase letters
 - Digits
 - Symbols (~!@#\$%^&*()_+|}{[<>./?')

5) In [Password(Retype)], re-enter the password entered in Step 4).

6) Click [Change].

- Setting of the administrator account is completed.

7) Enter the user name and password on the displayed login screen.

Sign in to access this site

Authorization required by http://192.168.10.100
Your connection to this site is not secure

Username

Password

- Enter the user name and password of the administrator account, or the user name and password of a standard user account without administrator rights.
- After logging in with the administrator account, set the user name and password of the standard user account using the [Set up password] page. For details, refer to “[Set up password] page (for administrator account)” (➡ page 139).

8) Click [Sign in] or [OK].

Attention

- The entry screen for the user name and password may be hidden by other window that is already opened. In such case, minimize the window in front to display the entry screen.

Note

- If you use a web browser to control the projector, set the [NETWORK] menu → [NETWORK CONTROL] → [WEB CONTROL] to [ON].
- Do not perform setting or control simultaneously by starting up multiple web browsers. Do not set or control the projector from multiple computers.
- Access will be locked for few minutes when an incorrect password is entered three times consecutively.
- Some items on the projector setting page use the JavaScript function of the web browser. The projector may not be able to be controlled properly if it is set with a browser that does not have this function enabled.
- If the screen for the web control is not displayed, consult your network administrator.
- While updating the screen for the web control, the screen may become white for a moment, but it is not a malfunction.
- Click [License] on the upper right of the [Set up password] page to display the download page for the Open Source Software license.
- About computer screen illustrations
The screen size and the display may differ from this manual depending on the OS, web browser or the type of computer you are using.

Available functions per account

The administrator account allows use of all functions. There is a limitation in the functions that can be used with the standard user account. Select the account depending on the purpose.

The function that has ✓ in the administrator / standard user column indicates that it can be operated with their respective accounts.

Item	Function	Administrator	Standard User	Page
[Status]	[Projector status]	✓	✓	129
	Error information page	✓	✓	129
	[Network status]	✓	✓	130
[Projector control]	[Basic control]	✓	✓	130
	[Detail control]	✓	✓	131

Chapter 5 Operation of Function - Web control function

Item	Function	Administrator	Standard User	Page
[Detailed set up]	[Network config]	✓	—	131
	[Ping test]	✓	—	133
	[ECO management set up]	✓	—	133
	[Network security]	✓	—	134
	[Status notification]	✓	—	135
	[E-mail set up]	✓	—	135
	[Authentication set up]	✓	—	136
	[Port set up]	✓	—	138
	[Crestron tools]	✓	—	139
[Set up password]	User name of [Administrator]	✓	—	140
	User name of [User]	✓	—	140
	Password of [Administrator]	✓	—	140
	Password of [User]	✓	✓	140, 141
	Password of [PJLink]	✓	—	141
[Download]	Download Presenter Light	✓	✓	125
[License] ^{*1}	License downloading page	✓	✓	142

*1 Even if you have not set an administrator account, you can download the license from the [Set up password] page that appears when you access the projector.

Descriptions of items



1 Page tab

Pages are switched by clicking this item.

2 [Status]

The status of the projector is displayed by clicking this item.

3 [Projector control]

The [Projector control] page is displayed by clicking this item.

4 [Detailed set up]

The [Detailed set up] page is displayed by clicking this item.

5 [Set up password]

The [Set up password] page is displayed by clicking this item.

6 [Download]

The download page of Presenter Light software is displayed by clicking this item. (➔ page 125)

7 [License]

Click it to go to the page for downloading Open Source Software licenses.

[Projector status] page

Click [Status] → [Projector status].

Display the status of the projector for the following items.

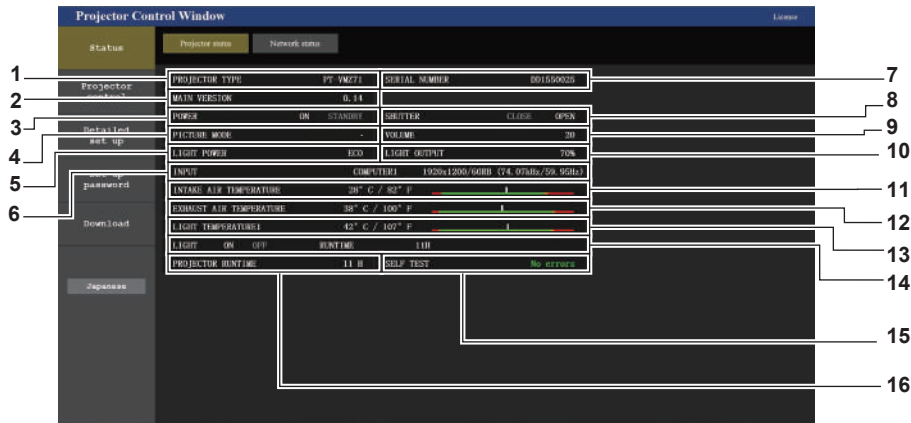

- | | |
|---|--|
| <p>1 [PROJECTOR TYPE]
Displays the type of the projector.</p> <p>2 [MAIN VERSION]
Displays the firmware version of the projector.</p> <p>3 [POWER]
Displays the status of the power.</p> <p>4 [PICTURE MODE]
Displays the setting status of [PICTURE MODE].</p> <p>5 [LIGHT POWER]
Displays the setting status of [LIGHT POWER].</p> <p>6 [INPUT]
Displays the status of the selected input.</p> <p>7 [SERIAL NUMBER]
Displays the serial number of the projector.</p> <p>8 [SHUTTER]
Displays the status of the shutter. ([CLOSE]: Shutter function enabled; [OPEN]: Shutter function disabled)</p> <p>9 [VOLUME]
Displays the volume status.</p> | <p>10 [LIGHT OUTPUT]
Displays the setting status of [LIGHT OUTPUT].</p> <p>11 [INTAKE AIR TEMPERATURE]
Displays the status of the air intake temperature of the projector.</p> <p>12 [EXHAUST AIR TEMPERATURE]
Displays the status of the exhaust air temperature of the projector.</p> <p>13 [LIGHT TEMPERATURE1] / [LIGHT TEMPERATURE2]
([LIGHT TEMPERATURE2] is only for PT-VMZ51, PT-VMZ51S, PT-VMZ41 and PT-VMW51)
Displays the temperature status of light source 1 and light source 2.</p> <p>14 [LIGHT]
Displays the lighting status and runtime of the light source.</p> <p>15 [SELF TEST]
Displays the self-diagnosis information.</p> <p>16 [PROJECTOR RUNTIME]
Displays the runtime of the projector.</p> |
|---|--|

Error information page

When [Error (Detail)] or [Warning (Detail)] is displayed in the [SELF TEST] display field of the [Projector status] screen, click it to display the content of the error/warning.

- The projector may go into the standby status to protect the projector depending on the contents of the error.

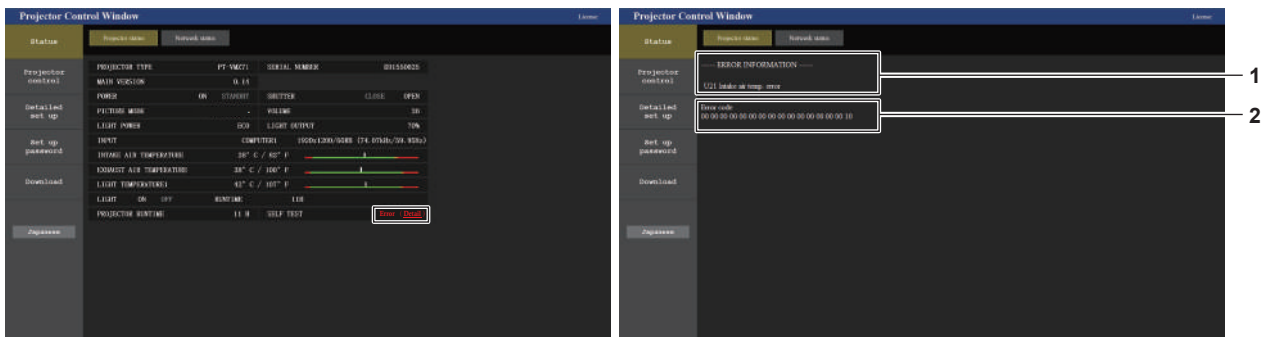

- | | |
|--|----------------------------|
| <p>1 Display of error information
Displays the alphanumeric symbols and content of errors/warnings that occur. For the details of the display content, refer to “[SELF TEST] display” (➔ page 153).</p> | <p>2 Error code</p> |
|--|----------------------------|

[Network status] page

Click [Status] → [Network status].
The current network setting status is displayed.

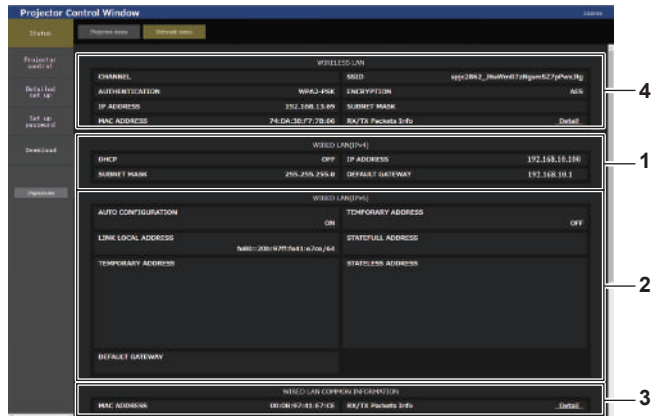
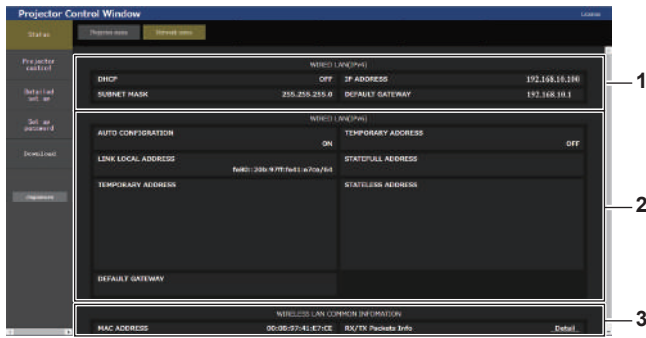

- 1 **[WIRED LAN (IPv4)]**
Displays the settings of wired LAN (IPv4).
- 2 **[WIRED LAN (IPv6)]**
Displays the settings of wired LAN (IPv6).
- 3 **[WIRED LAN COMMON INFORMATION]**
Displays the common information of wired LAN (IPv4) and wired LAN (IPv6).
- 4 **[WIRELESS LAN]**
Displays the settings of wireless LAN when the optional Wireless Module (Model No.: AJ-WM50 Series) is attached.

[Basic control] page

Click [Projector control] → [Basic control].

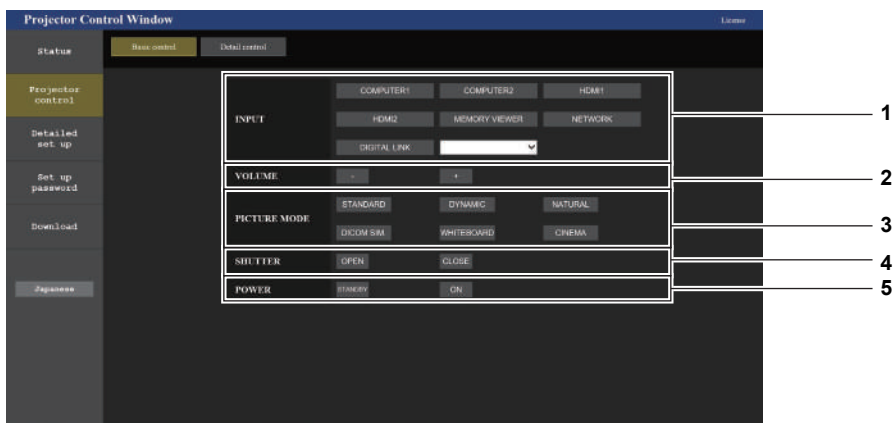

- 1 **[INPUT]**
Switches the image input to be projected.
- 2 **[VOLUME]**
Adjusts the volume level.
- 3 **[PICTURE MODE]**
Switches the picture mode.
- 4 **[SHUTTER]**
Switches the status of the shutter. ([CLOSE]: Shutter function enabled; [OPEN]: Shutter function disabled)
- 5 **[POWER]**
Turns on/off the power.

[Detail control] page

Click [Projector control] → [Detail control].



1 **[POSITION]**
Operates field angle-related settings.

2 **[PICTURE]**
Operates picture quality settings.

[Network config] page

Click [Detailed set up] → [Network config].

- 1) **Click [Network config].**
 - The **[CAUTION!]** screen is displayed.

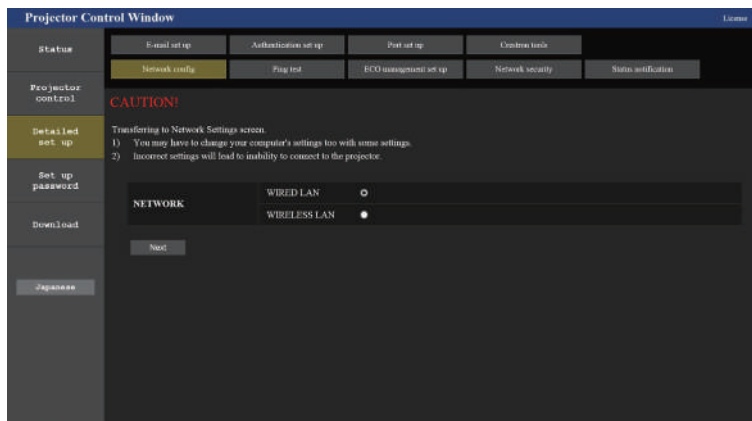

- 2) **Select the item which you want to change the setting.**
 - The [WIRELESS LAN] setting can be selected only when the optional Wireless Module (Model No.: AJ-WM50) is attached.
- 3) **Click [Next].**
 - The current setting is displayed.
- 4) **Click [Change] button.**
 - The setting change screen is displayed.

For wired LAN connection

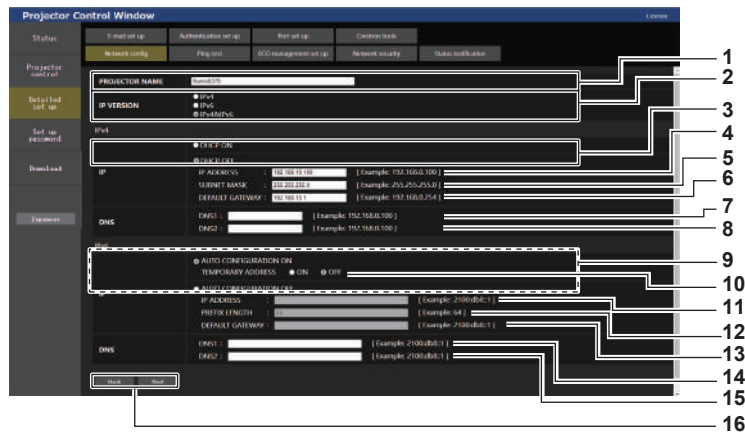

- | | |
|--|---|
| <p>1 [PROJECTOR NAME]
Enter the name of the projector. Enter the host name if it is required when using a DHCP server etc.</p> <p>2 [IP VERSION]
[IPv4]: Use only the IPv4 protocol.
[IPv6]: Use only the IPv6 protocol.
[IPv4 & IPv6]: Both the “IPv4” and the “IPv6” protocols can be used.</p> <p>3 [DHCP ON], [DHCP OFF]
To enable the DHCP client function, set to [DHCP ON].</p> <p>4 [IP ADDRESS]
Enter the IPv4 address if a DHCP server is not used.</p> <p>5 [SUBNET MASK]
Enter the subnet mask if a DHCP server is not used.</p> <p>6 [DEFAULT GATEWAY]
Enter the default gateway address for IPv4 if a DHCP server is not used.</p> <p>7 [DNS1]
Enter the DNS1 server address (primary) for IPv4.
Allowed characters:
Numbers (0 - 9), period (.)</p> <p>8 [DNS2]
Enter the DNS2 server address (secondary) for IPv4.
Allowed characters:
Numbers (0 - 9), period (.)</p> | <p>9 [AUTO CONFIGURATION ON], [AUTO CONFIGURATION OFF]
Select [AUTO CONFIGURATION ON] to automatically assign IPv6 address.</p> <p>10 [TEMPORARY ADDRESS]
Select [ON] to use the temporary IPv6 address.</p> <p>11 [IP ADDRESS]
Enter the IPv6 address when the IPv6 address is not automatically assigned.</p> <p>12 [PREFIX LENGTH]
Enter the prefix length when the IPv6 address is not automatically assigned.</p> <p>13 [DEFAULT GATEWAY]
Enter the default gateway address for IPv6 when the IPv6 address is not automatically assigned.</p> <p>14 [DNS1]
Enter the DNS1 server address (primary) for IPv6.
Allowed characters: hexadecimal numbers (0 - f), colon (:)</p> <p>15 [DNS2]
Enter the DNS2 server address (secondary) for IPv6.
Allowed characters: hexadecimal numbers (0 - f), colon (:)</p> <p>16 [Back], [Next]
Click [Back] to return to the original screen. Click [Next] to display the setting confirmation screen. Click [Submit] to update the setting.</p> |
|--|---|

Note

- When you use the “Forward” and “Back” functions of your browser, a warning message “Page has Expired” may appear. In that case, click [Network config] again since the following operation will not be guaranteed.
- Changing LAN settings while connected to the LAN may cause the connection to cut out.

For wireless LAN connection

(Only when the wireless module is attached)

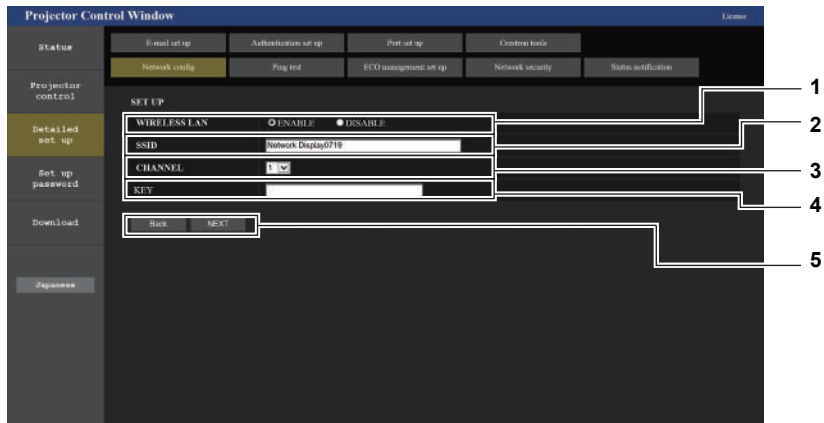

- 1 **[WIRELESS LAN]**
Selects [ENABLE] when you want to enable the wireless LAN function.
- 2 **[SSID]**
Sets the SSID for use.
- 3 **[CHANNEL]**
Selects the channel for use.

- 4 **[KEY]**
Sets the connection key.
Enter 8 to 15 characters of single-byte alphanumeric.
- 5 **[Back], [Next]**
Click the [Back] button to return to the original screen. The current settings are displayed by pressing the [Next] button.

Note

- Changing LAN settings while connected to the LAN may cause the connection to cut out.
- The setting values of the [Network config] page will return to the factory default when the [INITIALIZE] of the [NETWORK] menu is executed (➔ page 114).

[Ping test] page

Check whether the network is connected to the E-mail server, POP server, DNS server, etc.
Click [Detailed set up] → [Ping test].

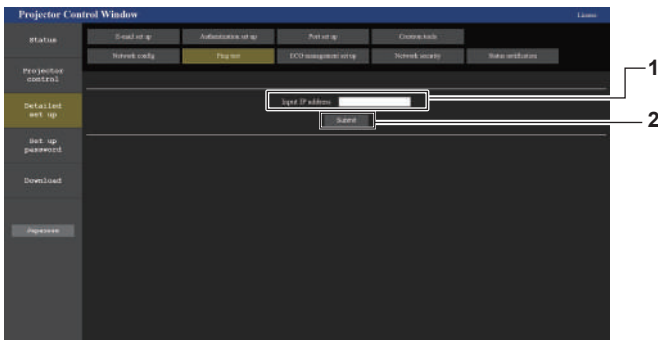

- 1 **[Input IP address]**
Enter the IP address of the server to be tested.
- 2 **[Submit]**
Execute the connection test.

```
PING 127.28.120.1 (127.28.120.1): 56 data bytes
64 bytes from 127.28.120.1: seq=0 ttl=64 time=0.970 ms
64 bytes from 127.28.120.1: seq=1 ttl=64 time=1.276 ms
64 bytes from 127.28.120.1: seq=2 ttl=64 time=0.724 ms
64 bytes from 127.28.120.1: seq=3 ttl=64 time=0.733 ms

--- 127.28.120.1 ping statistics ---
4 packets transmitted, 4 packets received, 0% packet loss
round-trip min/avg/max = 0.724/0.925/1.276 ms
```

```
PING 128.28.121.1 (128.28.121.1): 56 data bytes

--- 128.28.121.1 ping statistics ---
4 packets transmitted, 0 packets received, 100% packet loss
```

- 3 **Example of display when the connection has succeeded**
- 4 **Example of display when the connection has failed**

[ECO management set up] page

Settings related to the ECO management function of the projector can be made.
Click [Detailed set up] → [ECO management set up].



- | | |
|--|--|
| <p>1 [LIGHT POWER]
Displays the [LIGHT POWER] setting.</p> <p>2 [AUTO POWER SAVE]
Sets to [ON] when setting [AMBIENT LIGHT DETECTION] and [SIGNAL DETECTION].</p> <p>3 [AMBIENT LIGHT DETECTION]
Selects to enable ([ON])/disable ([OFF]) the environmental luminance interlock function.</p> <p>4 [SIGNAL DETECTION]
Selects to enable ([ON])/disable ([OFF]) the no signal interlock function.</p> | <p>5 [POWER MANAGEMENT]
Selects the power consumption mode.</p> <p>6 [TIMER]
Selects the time that the light source is turned off when the POWER MANAGEMENT function is using.</p> <p>7 [QUICK STARTUP]
Displays the [QUICK STARTUP] setting.</p> <p>8 [VALID PERIOD]
Select the valid period until the [QUICK STARTUP] function is disabled after going into the standby mode.</p> <p>9 [Submit]
Updates the settings.</p> |
|--|--|

Note

- For details of each setting item, refer to the [PROJECTOR SETUP] menu → [ECO MANAGEMENT] (➡ page 90) on the projector.

[Network security] page

Make settings to protect the projector from external attacks via LAN and unauthorized use.
Click [Detailed set up] → [Network security].

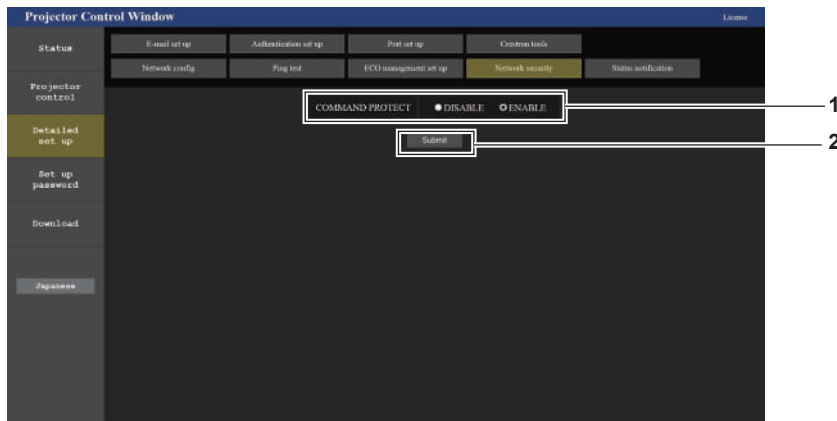

- | | |
|---|--|
| <p>1 [COMMAND PROTECT]
Make settings for the connection authentication when using the command control function.
[DISABLE]: Connect to the projector in non-protected mode. Connection authentication is not performed.
[ENABLE]: Connect to the projector in protected mode. The user name and password of the administrator account are required for the connection authentication.</p> | <p>2 [Submit]
Update the settings.
If you click [Submit] with [DISABLE] selected in [COMMAND PROTECT], a confirmation screen will be displayed. Click [OK] on the confirmation screen to update the settings.</p> |
|---|--|

Note

- When [COMMAND PROTECT] is set to [DISABLE], connection authentication is not performed, making it vulnerable to threats on the network. Be aware of the risks before making settings.
- For details on how to use the command control function, refer to “Control commands via LAN” (➡ page 157).

[Status notification] page

Set the push notification function. A push notification of updated information is sent to the application software linked to the projector, such as the “Multi Monitoring & Control Software”, when there is a change in status, such as occurrence of an error in the projector.

Click [Detailed set up] → [Status notification].

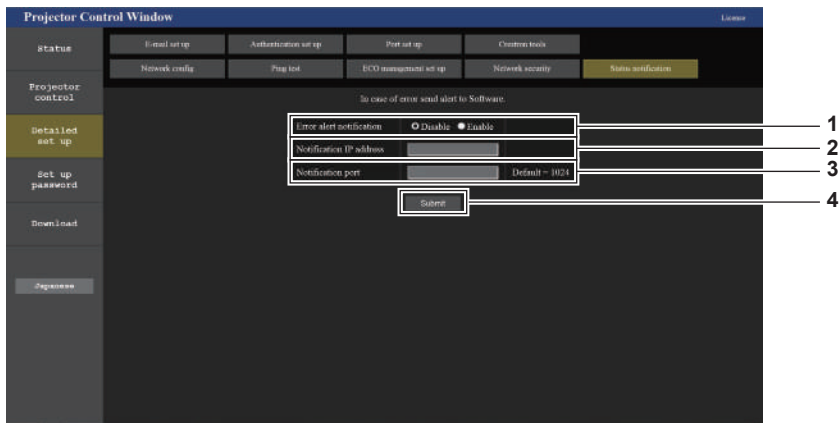

- 1 **[Error alert notification]**
Set to [ENABLE] to use the push notification function.
- 2 **[Notification IP address]**
Enter the IPv4 address of the notification destination.
- 3 **[Notification port]**
Enter the port number of the notification destination.
- 4 **[Submit]**
Update the settings.

[E-mail set up] page

When there is a problem or the runtime of a luminous lamp reaches a set value, an E-mail can be sent to preset E-mail addresses (up to two addresses).

Click [Detailed set up] → [E-mail set up].

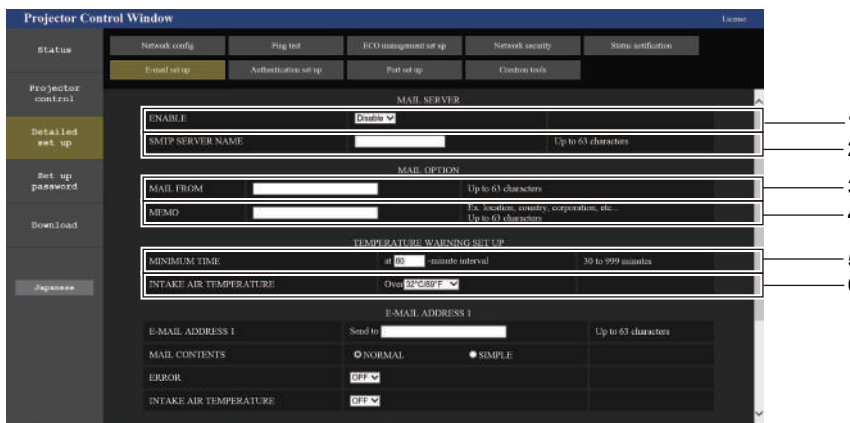

- 1 **[ENABLE]**
Select [Enable] to use the E-mail function.
- 2 **[SMTP SERVER NAME]**
Enter the IP address or the server name of the E-mail server (SMTP). To enter the server name, the DNS server needs to be set up.
- 3 **[MAIL FROM]**
Enter the E-mail address of the projector. (Up to 63 characters in single byte)
- 4 **[MEMO]**
Enter information such as the location of the projector that notifies the sender of the E-mail. (Up to 63 characters in single byte)
- 5 **[MINIMUM TIME]**
Change the minimum interval for the temperature warning E-mail. The default value is 60 minutes. In this case, another E-mail will not be sent for 60 minutes after sending the temperature warning E-mail even if it reaches the warning temperature.
- 6 **[INTAKE AIR TEMPERATURE]**
Change the temperature setting for the temperature warning mail. A temperature warning E-mail is sent when the temperature exceeds this value.

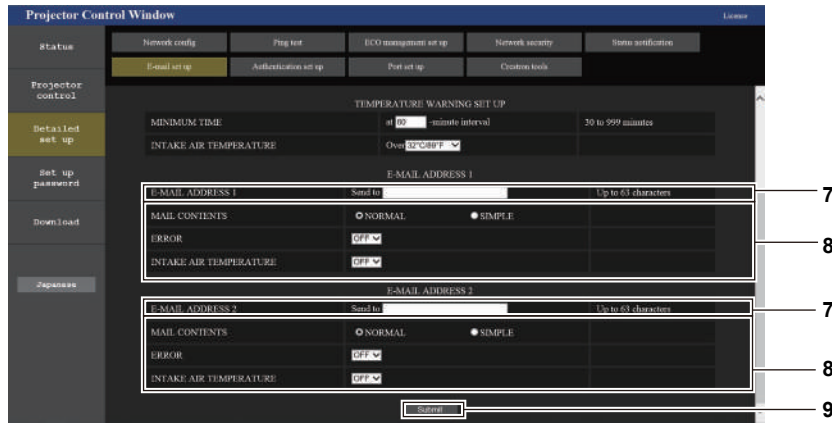

- 7 **[E-MAIL ADDRESS 1], [E-MAIL ADDRESS 2]**
Enter the E-mail address to be sent. Leave [E-MAIL ADDRESS 2] blank when two E-mail addresses are not to be used.
- 8 **Settings of the conditions to send E-mail**
Selects the conditions to send E-mail.
[MAIL CONTENTS]:
Selects either [NORMAL] or [SIMPLE].
[ERROR]:
Sends an E-mail when an error has occurred in the self-diagnosis.
- [INTAKE AIR TEMPERATURE]:**
Sends an E-mail when the air intake temperature has reached the value set at the above field.
- 9 **[Submit]**
Updates the settings.

[Authentication set up] page

Set the authentication items when POP authentication or SMTP authentication is necessary to send an E-mail. Click [Detailed set up] → [Authentication set up].

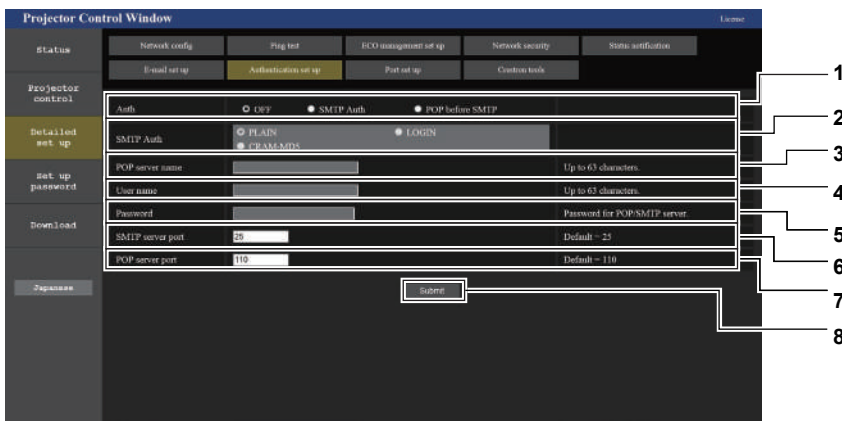

- 1 **[Auth]**
Selects the authentication method specified by your Internet service provider.
- 2 **[SMTP Auth]**
Set when the SMTP authentication is selected.
- 3 **[POP server name]**
Enter the POP server name.
Allowed characters:
Alphanumerics (A - Z, a - z, 0 - 9)
Minus sign (-) period (.) colon (:)
- 4 **[User name]**
Enter the user name for the POP server or the SMTP server.
- 5 **[Password]**
Enter the password for the POP server or the SMTP server.
- 6 **[SMTP server port]**
Enter the port number of the SMTP server. (Normally 25)
- 7 **[POP server port]**
Enter the port number of the POP server. (Normally 110)
- 8 **[Submit]**
Updates the settings.

Contents of E-mail sent

Example of E-mail sent when E-mail is set

The following E-mail is sent when the E-mail settings have been established.

```
=== Panasonic projector report(CONFIGURE) ===
Projector Type      : PT-VMZ71
Serial No          : 000000000

----- E-mail setup data -----
TEMPERATURE WARNING SETUP
MINIMUM TIME       at [ 30] minutes interval
INTAKE AIR TEMPERATURE Over [ 32 degC / 89 degF ]

ERROR              [ OFF ]
INTAKE AIR TEMPERATURE [ OFF ]

----- Error information -----

Error Code
 00 00 00 00 00 00 00 00 00 00 00 00 00 00 00 00

Intake air temperature      : 27 degC / 80 degF
Exhaust air temperature    : 30 degC / 86 degF
Light temperature1        : 64 degC / 147 degF
PROJECTOR RUNTIME          21 H
LIGHT RUNTIME              21 H

----- Current status -----
MAIN VERSION               1.00
SUB VERSION                1.00
LIGHT STATUS               LIGHT=ON
INPUT                      NETWORK

----- Wired network configuration (IPv4) -----
DHCP Client                OFF
IP address                  192.168.0.8
MAC address                 12:34:56:78:90:12

----- Wired network configuration (IPv6) -----
Auto Configuration        ON
Link Local Address        fe80::20b:97ff:fe41:e7e5
MAC address                00:0B:97:41:E7:E5

----- Memo -----
```

Example of the E-mail sent for an error

The following E-mail is sent when an error has occurred.

```

=== Panasonic projector report(ERROR) ===
Projector Type       : PT-VMZ71
Serial No           : 000000000

----- Error information -----
FE6 Power fan error

Error Code
 00 00 00 00 00 00 00 00 00 00 80 00 00 00 00 00

Intake air temperature      : 27 degC / 80 degF
Exhaust air temperature     : 30 degC / 86 degF
Light temperature          : 64 degC / 147 degF
PROJECTOR RUNTIME          : 21 H
LIGHT RUNTIME               : 21 H

----- Current status -----
MAIN VERSION                1.00
SUB VERSION                 1.00
LIGHT STATUS                 LIGHT=ON
INPUT                       NETWORK

----- Wired network configuration (IPv4) -----
DHCP Client                 OFF
IP address                  192.168.0.8
MAC address                 12:34:56:78:90:12

----- Wired network configuration (IPv6) -----
Auto Configuration         ON
Link Local Address         fe80::20b:97ff:fe41:e7e5
MAC address                 00:0B:97:41:E7:E5

----- Memo -----
    
```

Note

- Information of the wireless LAN is displayed when the optional Wireless Module (Model No.: AJ-WM50) is attached.

[Port set up] page

Set the port number used for command control.

Click [Detailed set up] → [Port set up].



1 [COMMAND PORT]
Set the port number used for command control.

2 [Set command port]
Update the settings.

[Crestron tools] page

Set the information required to connect the Crestron control system to the projector.
Click [Detailed set up] → [Crestron tools].

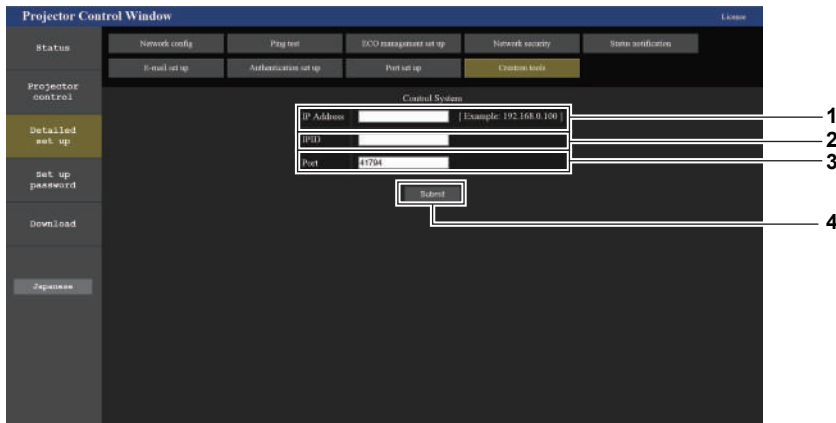

- | | |
|---|---|
| <p>1 [IP Address]
Set the IP address of the control system.</p> <p>2 [IPID]
Set the IPID of the control system.</p> | <p>3 [Port]
Set the port number of the control system.</p> <p>4 [Submit]
Update the settings.</p> |
|---|---|

Note

- Set the [NETWORK] menu → [NETWORK CONTROL] → [Crestron Connected(TM)] (→ page 110) to [ON] if information prompting users to confirm projector's settings is displayed on the [Crestron tools] page.

[Set up password] page (for administrator account)

Click [Set up password].

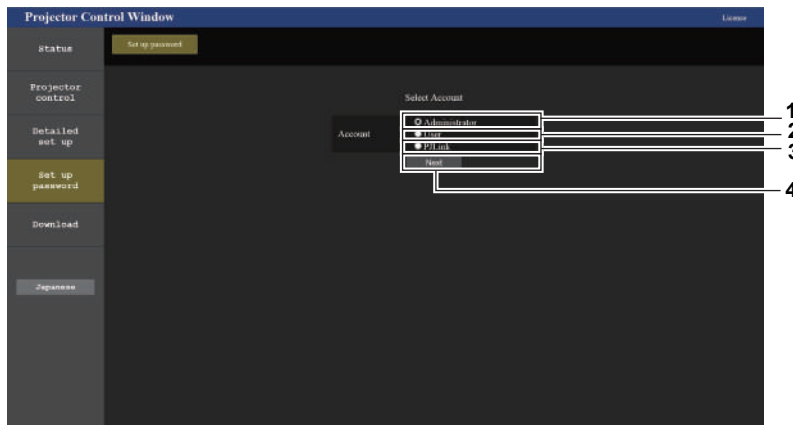

- | | |
|--|--|
| <p>1 [Administrator]
Used to change the setting of the administrator account.</p> <p>2 [User]
Used to change the setting of the standard user account.</p> | <p>3 [PJLink]
Used to change the setting of the PJLink account.</p> <p>4 [Next]
Displays the screen to change the setting of the password.</p> |
|--|--|

[Administrator]

The user name and password of the administrator account can be set.

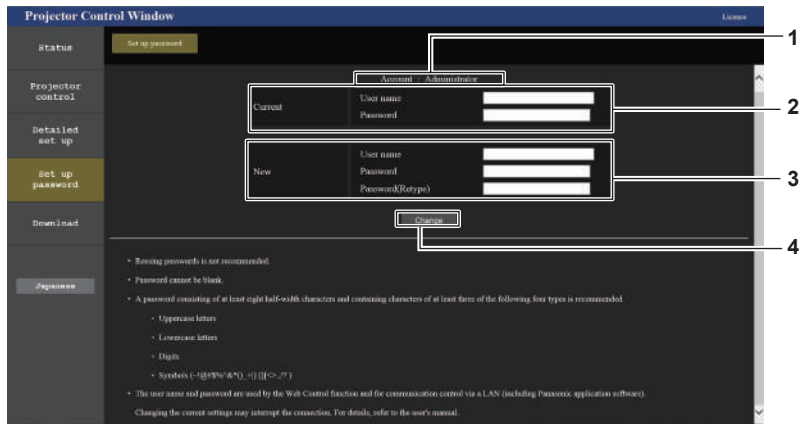

- 1 **[Account]**
Displays the account to change.
- 2 **[Current]**
[User name]:
Enter the current user name.
[Password]:
Enter the current password.

- 3 **[New]**
[User name]:
Enter the desired new user name. (Up to 16 characters in single byte)
[Password]:
Enter the desired new password. (Up to 16 characters in single byte)
[Password(Retyp)]:
Enter the desired new password again.
- 4 **[Change]**
Determines the change of password.

Note

- When the projector is already registered in application software (such as “Multi Monitoring & Control Software”) which uses the communication control via LAN, communication with the projector will become impossible if the user name or password for [Administrator] is changed. If the user name or password for [Administrator] is changed, update the registration information of the application software in use.

[User]

The user name and password of the standard user account can be set.

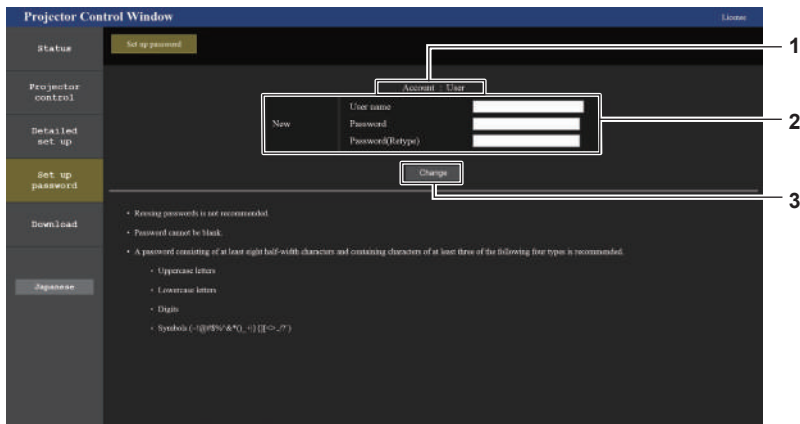

- 1 **[Account]**
Displays the account to change.
- 2 **[New]**
[User name]:
Enter the desired new user name. (Up to 16 characters in single byte)
[Password]:
Enter the desired new password. (Up to 16 characters in single byte)
[Password(Retyp)]:
Enter the desired new password again.

- 3 **[Change]**
Determines the change of password.

[PJLink]

The password of the PJLink account can be changed.



- 1 **[Account]**
Displays the account to change.
- 2 **[New Password]:**
Enter the desired new password. (Up to 32 characters in single byte)
- 3 **[Change]**
Determines the change of password.

[Set up password] (for standard user account)

The password of the standard user account can be changed.

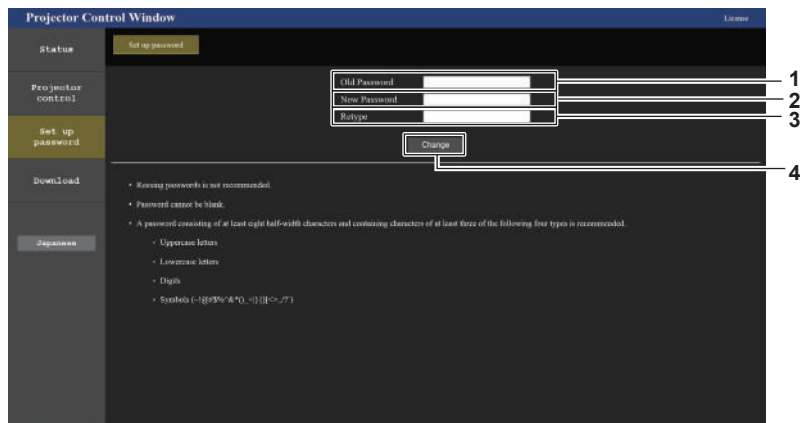

- 1 **[Old Password]**
Enter the current password.
- 2 **[New Password]**
Enter the desired new password. (Up to 16 characters in single byte)
- 3 **[Retype]**
Enter the desired new password again.
- 4 **[Change]**
Determines the change of password.

License download page

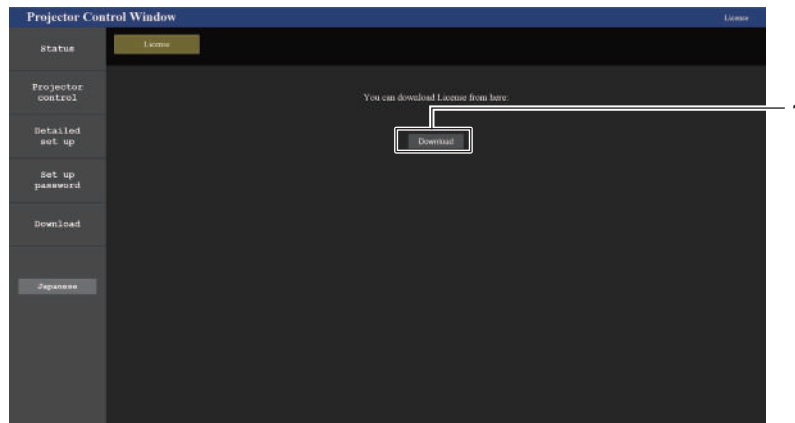

1 [Download]

The license for the open source software used in the projector is downloaded by clicking this item. Specify the destination to save and download the license.

Note

- Provided license is a text file, and it is saved in the firmware of the projector in zip format compressed file.
File name: License.zip

Using HDMI-CEC function

HDMI-CEC function allows the basic operation of CEC-compatible device with the projector remote control or the link control between the projector and CEC-compatible device.

Connecting a CEC-compatible device

Connect a CEC-compatible device to the <HDMI IN 1> terminal or <HDMI IN 2> terminal.

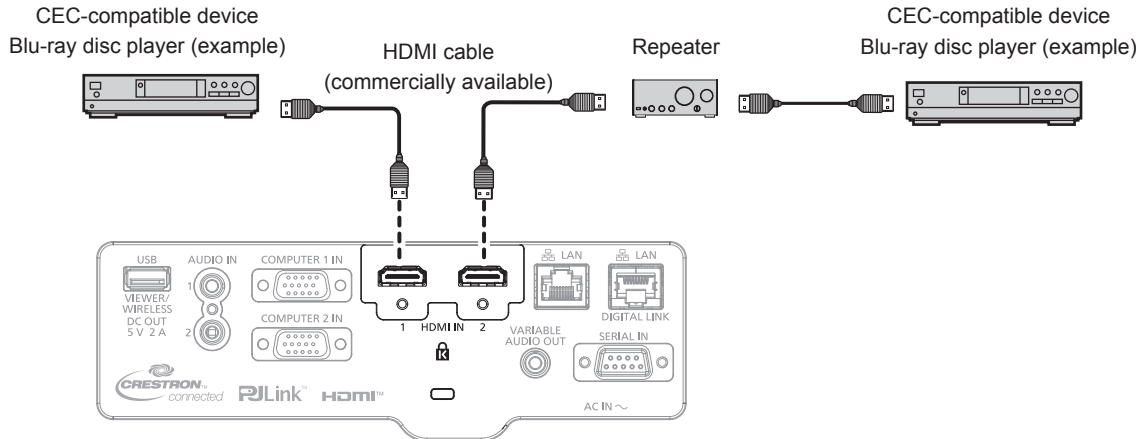

Connection example with CEC-compatible device

Setting the projector and CEC-compatible device

Before using the HDMI-CEC function, you need to configure the settings on the projector and the CEC-compatible device.

- CEC-compatible device: enable the HDMI-CEC function.
- Projector: Set the [PROJECTOR SETUP] menu → [HDMI CEC] to [ON]. (➡ page 97)

Note

- After switching on the CEC-compatible device, switch on the projector and select HDMI1 input or HDMI2 input, then check that the image from the CEC-compatible device is projected correctly.

Operating the CEC-compatible device with the projector remote control

You can operate the device using the projector remote control by calling up the operation menu of the CEC-compatible device from the HDMI-CEC operation screen. Use the number buttons (<2>, <5>, <8>) on the remote control to select the operation item on the HDMI-CEC operation screen.

About the HDMI-CEC operation screen, refer to “Operating a CEC-compatible device” (➡ page 97).

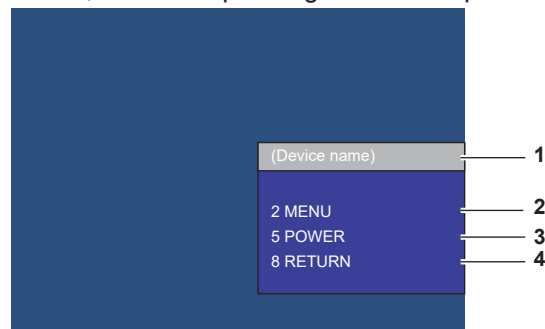

HDMI-CEC operation screen

- | | |
|--|--|
| <p>1 Displays the device name to be operated.</p> <p>2 [MENU]
Call up the operation menu of the CEC-compatible device.</p> | <p>3 [POWER]
Switch on/off the device.</p> <p>4 [RETURN]
Returns the operation menu of the CEC-compatible device to the previous screen.</p> |
|--|--|

Note

- If the operation menu of the CEC-compatible device cannot be called up from the HDMI-CEC operation screen, change the menu code setting. For the operation details, refer to “Changing the menu code” (➡ page 98).

- If you cannot operate the operation menu of a CEC-compatible device, try setting the [PROJECTOR SETUP] menu → [HDMI CEC] to [OFF] and [ON] again. It may be improved.
- While the HDMI-CEC operation screen is displayed, only the number buttons on the remote control can be used and other button operations are disabled.

Menu operation of CEC-compatible device

When the setting menu of the CEC-compatible device is displayed, you can use the ▲▼◀▶ buttons and <ENTER> button of the remote control to operate the menu.

About the link control

By setting the [PROJECTOR SETUP] menu → [HDMI CEC] → [PROJECTOR -> DEVICE] / [DEVICE -> PROJECTOR] to a setting other than [DISABLE], the following link operations can be achieved.

The link control setting of [PROJECTOR -> DEVICE]

■ When the setting is [POWER OFF] or [POWER ON / OFF]

- If the projector is switched off, all connected CEC-compatible devices are switched off.

■ When the setting is [POWER ON / OFF]

- If the input channel is HDMI1 or HDMI2 when the projector is switched on and starts projection, then the CEC-compatible devices connected to the <HDMI IN 1> terminal or <HDMI IN 2> terminal are switched on upon startup of the projector.

The link control setting of [DEVICE -> PROJECTOR]

■ When the setting is [POWER ON] or [POWER ON / OFF]

- While the projector is in standby, if the CEC-compatible device is turned on, the projector turns on and switches to the input that the CEC-compatible device is connected.
- While the projector is in standby, if the CEC-compatible device starts playing, the projector turns on and switches to the input that the CEC-compatible device is connected.
- While the projector is turned on, if the CEC-compatible device starts playing, the projector switches to the input that the CEC-compatible device is connected.

■ When the setting is [POWER ON / OFF]

- When the CEC-compatible device connected to the selected → input (HDMI1 or HDMI2) is switched off, the projector enters standby mode.

Note

- Depending on the status of the device, such as when the projector or the CEC-compatible device is starting up, the link control may not operate normally.
- If the CEC-compatible device does not support CEC 1.4, it may not support the link control described in the manual.
- Depending on the connected CEC-compatible device, the link control may not operate normally.

Chapter 6 Maintenance

This chapter describes methods of inspection when there are problems, maintenance and replacement of the units.

Light source and temperature indicators

When an indicator lights up

If a problem should occur inside the projector, the light source indicator <LIGHT> and the temperature indicator <TEMP> will inform you by lighting or blinking. Check the status of the indicators and remedy the indicated problems as follows.

Attention

- Before you take a remedial measure, follow the procedure of switching the power off indicated in “Switching off the projector” (➔ page 52).

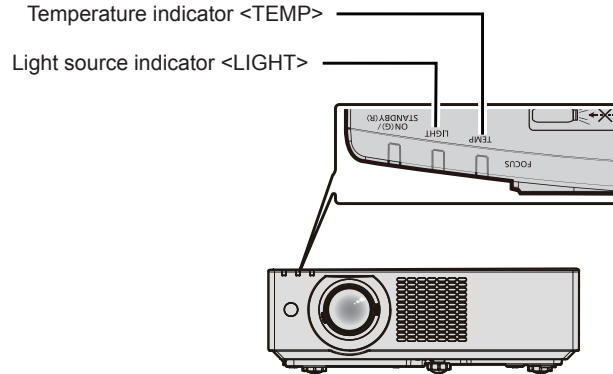

Light source indicator <LIGHT>

Indicator status	Blinking red (1 time)	Blinking red (2 times)	Blinking red (3 times)
Status	Some of the elements of the light source are defective and the light output has decreased.	The light source turns off or does not light up since the phosphor wheel is abnormal.	The light source does not light up, or the light source turns off while the projector is in use.
Solution	Disconnect the power cord plug from the outlet, and switch the power on again. The light source indicator <LIGHT> may not light up or blink.		

Note

- If the light source indicator <LIGHT> continues to light or blink even after the measure is taken, switch off the projector and remove the power cord plug from the outlet, then ask your dealer for repair.

Temperature indicator <TEMP>

Indicator status	Blinking red (3 times)		Blinking red (2 times)	
Status	The air filter is clogged, internal temperature is high (warning).	The air filter is clogged, internal temperature is high (standby status).	Fan rotation is abnormal and internal temperature is high (warning).	The projector detects an abnormal condition and cannot be turned on.
Check	<ul style="list-style-type: none"> • Is the intake/exhaust vent blocked? • Is the room temperature high? • Is the air filter unit dirty? 		-	
Remedy	<ul style="list-style-type: none"> • Remove any objects that are blocking the intake/exhaust vent. • Use the projector in an appropriate operating environment temperature*1. • Do not use the projector at high altitudes of 2 700 m (8 858') or higher above sea level. • Clean or replace the air filter unit. (➔ page 147) 		<ul style="list-style-type: none"> • Unplug the AC power cord and contact the dealer or the service center for service and checkup. 	

*1 For details of operating environment temperature of the projector, refer to “Operating temperature” (➔ page 165).

Note

- If the temperature indicator <TEMP> is still lighting or blinking after taking the preceding measures, ask your dealer for repair.

Maintenance/replacement

Before performing maintenance/replacement

- Make sure to turn off the power before maintaining the projector or replacing the unit.
- When switching off the projector, make sure to follow the procedures in “Switching off the projector” (➔ page 52).

Maintenance

Outer case

Wipe off dirt and dust with a soft, dry cloth.

- If the dirt is persistent, soak the cloth with water and wring it thoroughly before wiping. Dry off the projector with a dry cloth.
- Do not use benzene, thinner, or rubbing alcohol, other solvents, or household cleaners. Doing so may deteriorate the outer case.
- When using chemically treated dust cloths, follow the instructions written on its packaging.

Lens front surface

Wipe off dirt and dust from the front surface of the lens with a soft clean cloth.

- Do not use a cloth that is fluffy, dusty, or soaked with oil/water.
- Since the lens is fragile, do not use excessive force when wiping the lens.

Attention

- The lens may be damaged if you hit with a hard object or wipe with excessive force. Handle with care.



DO NOT WIPE THE LENS DURING OPERATION

Cleaning the lens during operation may cause foreign objects adhering to the lens or bring damage to the lens surface.

Air filter unit

This section describes the maintenance of the air filter unit that is installed as standard on the projector.

The air filter unit is the same as the optional Replacement Filter Unit (Model No.: ET-RFV500).

In the following cases, remove the air filter unit and check the clogging condition of the air filter. If the air filter is clogged, clean the air filter unit.

- The message of “CLEAN THE AIR FILTER” is displayed on the projection screen.
- The temperature indicator <TEMP> blinks red (3 times) (➔ page 146).
- The message of “FILTER COUNTER has reached the set time.” that prompts to perform maintenance of the air filter unit is displayed on the projection screen.

Attention

- Make sure to turn off the power before performing maintenance of the air filter. (➔ pages 47, 52)
- Make sure that the projector is stable, and perform the maintenance in a safe place even if the air filter unit falls accidentally.
- Take care not to remove the sponge (Fig. 1) on the side of the air filter unit when removing or attaching the air filter unit.

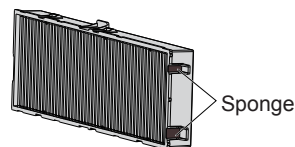

Fig. 1

Note

- Check the usage time of the air filter in the [PROJECTOR SETUP] menu → [FILTER COUNTER].(➔ page 96)
- Air filter replacement is recommended after washing the air filter two times for recycling.
- The air filter performance after washing may be reduced compared with its initial performance.
- The time until the air filter is clogged varies greatly depending on the usage environment.

Removing the air filter unit

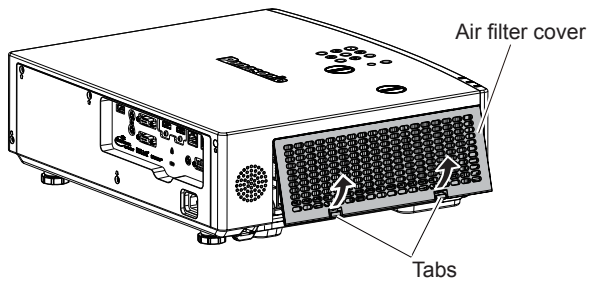

Fig. 1

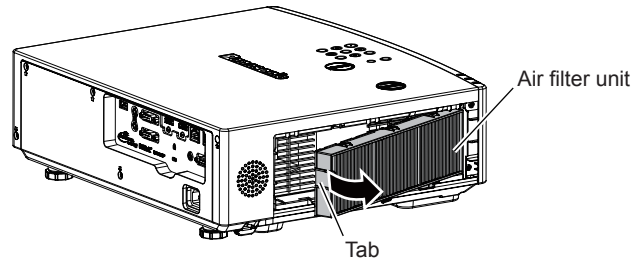

Fig. 2

1) Turn off the projector.

- When switching off the projector, make sure to follow the procedures in “Switching off the projector” (➔ page 52).

2) Remove the air filter cover. (Fig. 1)

- Push the tabs of the air filter cover upward as shown in the figure, remove them from the hooks of the projector and open it in the direction of the arrow in the figure.

3) Remove the air filter unit. (Fig. 2)

- Put your finger on the tab on the left side of the air filter unit, open it in the direction of the arrow shown in the figure and remove it.
- After removing the air filter unit, remove the foreign objects and dust in the air filter unit compartment if there are any.
- After removing the air filter unit, proceed to “Performing maintenance of the air filter unit” (➔ page 148).

Note

- When using the projector, be sure to attach the air filter unit. If it is not attached, the projector will suck in dirt and dust causing a malfunction.

Performing maintenance of the air filter unit

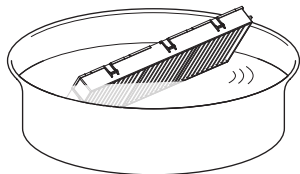

Fig. 1

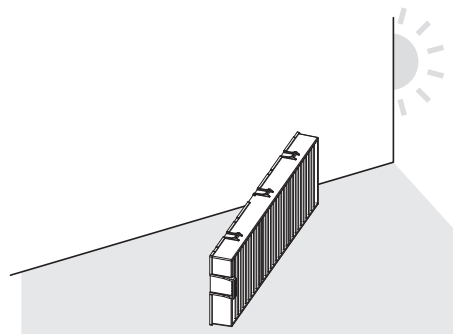

Fig. 2

1) Wash the air filter unit. (Fig. 1)

- Soak the air filter unit in cold or warm water and then lightly rinse it.
 - Do not use cleaning tools such as brushes.
 - When rinsing, hold the frame of the air filter unit without putting strong pressure on the filter.
- Rinse the air filter unit two or three times with fresh water.
 - Insufficient rinsing may result in odors.

2) Dry the air filter unit. (Fig. 2)

- Let the air filter unit naturally dry off in a well-ventilated place where there is little dust and is not exposed to direct sunlight.
- Do not dry using drying devices such as dryers.
- After the air filter unit is dried, proceed to “Attaching the air filter unit” (➔ page 149).

Attention

- After washing the air filter unit, dry it thoroughly before attaching it back to the projector. Attaching a wet unit will cause an electric shock or malfunction.
- Do not disassemble the air filter unit.

Note

- Replace the air filter unit with a new optional Replacement Filter Unit (Model No.: ET-RFV500) if it is damaged or if the dirt does not come off even after washing

Attaching the air filter unit

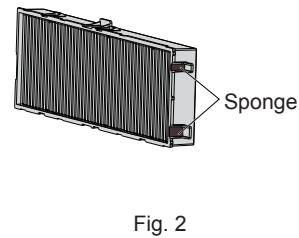
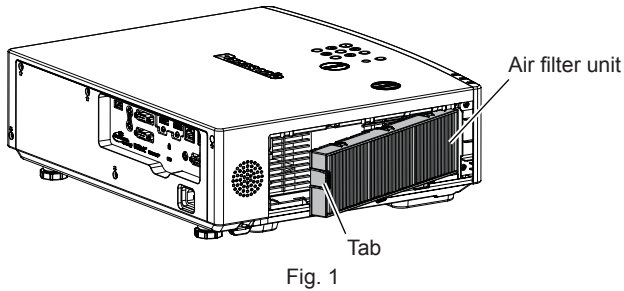

1) Attach the air filter unit to the projector. (Fig. 1)

- Hold the air filter unit with the tab on the left side as shown in the figure, attach it from the right side, and push the tab until it clicks.
- Take care not to remove the sponge (Fig. 2) on the side of the air filter unit when attaching the air filter unit.
- Do not press on the crease part of the air filter when pressing into place.

2) Attach the air filter cover to the projector.

- Perform in the reverse order of the Step 2) of “Removing the air filter unit” (➔ page 148) to close the air filter cover. Make sure to press the air filter cover firmly until it clicks into place.
- When the air filter unit is attached to the projector, proceed to the “Resetting the air filter counter” (➔ page 149).

Note

- When using the projector, be sure to attach the air filter unit. If it is not attached, the projector will suck in dirt and dust causing a malfunction.

Resetting the air filter counter

- 1) Turn on the projector.
- 2) Press the <MENU> button on the remote control or the control panel.
 - The main menu screen is displayed.
- 3) Press ▲▼ to select [PROJECTOR SETUP].
- 4) Press the <ENTER> button.
 - The [PROJECTOR SETUP] screen is displayed.
- 5) Press ▲▼ to select [FILTER COUNTER].
- 6) Press the <ENTER> button.
 - The [FILTER COUNTER] screen is displayed.
- 7) Press ▲▼ to select [FILTER COUNTER RESET] and press the <ENTER> button.
- 8) When the confirmation screen is displayed, press ◀▶ to select [OK], then press the <ENTER> button.
 - The [PROJECTOR SETUP] menu → [FILTER COUNTER] → [FILTER COUNTER] is displayed as “0H”.

Note

- When the projector is used without resetting the filter counter, the actual filter usage time (counter numeric value) will not be able to be confirmed.

Replacement

Air filter unit

If dirt does not come off even after the air filter unit is cleaned, it is time for the unit to be replaced. The Replacement Filter Unit (Model No.: ET-RFV500) is an optional accessory. To purchase the product, consult your dealer.

Attention

- Make sure to turn off the power before replacing the filter. (➔ page 52)
- Make sure that the projector is stable, and perform the maintenance in a safe place even if the air filter unit falls accidentally.

Note

- The replacement cycle of the air filter unit varies greatly depending on the usage environment.

How to replace the air filter unit

1) Remove the air filter unit.

- Refer to “Removing the air filter unit” (➔ page 148).

2) Install the optional Replacement Filter Unit (Model No.: ET-RFV500) to the projector.

- Refer to “Attaching the air filter unit” (➔ page 149).

3) Reset the air filter counter.

- Refer to “Resetting the air filter counter” (➔ page 149).

Attention

- When switching on the projector, make sure that the air filter unit is attached. If it is not attached, the projector will suck in dirt and dust causing a malfunction.
- If the projector is used without resetting the filter counter, the actual filter usage time (counter numeric value) will not be able to be confirmed.

Troubleshooting

Please check following points. For details, refer to the corresponding pages.

Problem	Points to be checked	Reference page
Power does not turn on.	<ul style="list-style-type: none"> Is the power plug firmly connected to the outlet? Is the wall outlet supplying electricity? Have the circuit breakers tripped? Is the light source indicator <LIGHT> or temperature indicator <TEMP> lit or blinking? 	— — — 146
No image appears.	<ul style="list-style-type: none"> Are connections to external devices correctly performed? Is the input selection setting correct? Is the [BRIGHTNESS] adjustment setting at a minimum? Is the external device that is connected to the projector working properly? Is the shutter function activated? 	40 53 69 — 57, 84
Image is fuzzy.	<ul style="list-style-type: none"> Is the lens cap still attached? Is the lens focus set correctly? Is the projection distance appropriate? Is the lens dirty? Is the projector installed perpendicular to the screen? 	33 55 36 23 —
Color is pale or grayish.	<ul style="list-style-type: none"> Is [COLOR] or [TINT] adjusted correctly? Is the external device connected to the projector adjusted correctly? Is the RGB signal cable damaged? 	70, 70 — —
No audio.	<ul style="list-style-type: none"> Is the external device connected correctly to the audio input terminal? Is the volume set to the minimum level? Is the shutter function activated? Is the mute function activated? Is the audio input selection in [AUDIO SETTING] set correctly? Is the cable connected to the <VARIABLE AUDIO OUT> terminal? If connected, the built-in speaker will not output audio. 	40 57, 94 57, 84 57, 94 95 40
Remote control does not work.	<ul style="list-style-type: none"> Are the batteries depleted? Is the polarity of the batteries set correctly? Are there any obstructions between the remote control and the remote control signal receiver of the projector? Is the remote control used beyond its effective operation range? Is the remote control subject to influences from fluorescent light, etc. Is the [REMOTE CONTROLLER] setting in [CONTROL DEVICE SETUP] set to [DISABLE]? Is the ID number setting operation correct? 	— 32 28, 29 28, 29 28, 29 102 63
Buttons on the control panel do not work.	<ul style="list-style-type: none"> Is the [CONTROL PANEL] setting in [CONTROL DEVICE SETUP] set to [DISABLE]? 	102
Image does not display correctly.	<ul style="list-style-type: none"> Is there a problem with the external device to output images? Is the signal input incompatible with the projector? 	— 168
Image from a computer does not appear.	<ul style="list-style-type: none"> Is the cable too long? (For D-Sub cables, the cable length should be 10 m (32'10") or shorter.) Is the external video output on the laptop computer set correctly? (Ex.: The external output settings may be switched by pressing the "Fn" + "F3" or "Fn" + "F10" simultaneously. Since the method varies depending on the computer type, refer to the user manual provided with your computer.) 	— 54
Video from HDMI compatible device does not appear or it appears jumbled.	<ul style="list-style-type: none"> Is the HDMI cable securely connected? Turn the power of the projector and the external device off and on. Is the signal input incompatible with the projector? 	40 — 168
Audio from HDMI compatible device is not output.	<ul style="list-style-type: none"> Set to the linear PCM audio for the connected devices. 	—
The DIGITAL LINK input image or sound is not output.	<ul style="list-style-type: none"> Is the cable compatible to the condition of the projector used? Are the connections between the twisted-pair-cable transmitter and the projector or an external device correctly done? Is [DIGITAL LINK MODE] set to [AUTO], [DIGITAL LINK] or [LONG REACH]? Is it set to [ETHERNET]? Is the signal input incompatible with the twisted-pair-cable transmitter? 	42 — 103 —

Chapter 6 Maintenance - Troubleshooting

Problem	Points to be checked	Reference page
No power supplied from <USB (VIEWER/WIRELESS/DC OUT)> terminal	<ul style="list-style-type: none"> • Is the [PROJECTOR SETUP] menu → [ECO MANAGEMENT] → [STANDBY MODE] set to [ECO] ? 	92
	<ul style="list-style-type: none"> • Has the external device connected to the <USB (VIEWER/WIRELESS/DC OUT)> terminal exceeded the rating (5 VDC, maximum 2 A)? 	31
Operation noise became loud.	If the temperature inside the projector becomes high, the speed of the internal cooling fan increases automatically and the operation noise becomes loud. If the internal temperature reaches the abnormal value, the indicators will light up or blink.	146
	<ul style="list-style-type: none"> • Is the ambient temperature high? 	20
	<ul style="list-style-type: none"> • Is the air filter unit dirty? 	147
	<ul style="list-style-type: none"> • Is the intake/exhaust vent blocked? 	20

Attention

- If the problem persists, after confirming the contents of the table, consult your dealer.

[SELF TEST] display

[SELF TEST] can be checked in the WEB control screen [Status] → [Projector status].

The following list shows the alphanumeric symbol that is displayed when an error or a warning has occurred and its details. Confirm “Action number”, and follow the measure in “Measure for error and warning” (➔ page 153).

Error/warning display	Details	Action number
U11	Intake air temp. warning	1
U13	Exhaust air temp. warning	1
U21	Intake air temp. error	1
U23	Exhaust air temp. error	1
FL5	Light Bank 1 warning	2
FL6	Light Bank 2 warning	2
FL7	Light Bank 3 warning ^{*1}	2
FL8	Light Bank 4 warning ^{*1}	2
FH0	PW error(SUB)	2
H11	Intake air temp. sensor error	2
H13	Exhaust air temp. sensor error	2
U04	Air filter clogged	4
FL1	Light unit error	3
FE1	Lcd R fan error	2
FE2	Lcd G fan error	2
FE3	Pbs fan error	2
FE4	Pw fan error ^{*2}	2
FE5	Light fan error	2
FE6	Power fan error	2
FE7	Motor fan error	2
U25	Light temperature 1 error	1
U27	Light temperature 2 error ^{*3}	1
F16	Angle sensor error	2
H14	Light temperature sensor 1 error	2
H16	Light temperature sensor 2 error ^{*3}	2
U16	Light temperature 1 warning	1
U18	Light temperature 2 warning ^{*3}	1
F18	Air pressure sensor error	2
F61	Light driver communication error	2
U78	Air filter clogged	4

*1 Only for PT-VMZ71, PT-VMZ61 and PT-VMW61.

*2 Only for PT-VMZ71.

*3 Only for PT-VMZ51, PT-VMZ51S, PT-VMZ41 and PT-VMW51.

Note

- The self-diagnosis display and the details of the malfunction may be different.
- For errors and warnings that are not described in the table, consult your dealer.

■ Measure for error and warning

Action number	Measure
1	The operating environment temperature is too high. Use the projector in an appropriate operating environment temperature ^{*1} .
2	If the error/warning display does not go off even after unplugging the power plug from the outlet and turning on the power again, consult your dealer.
3	The light source has failed to turn on. If the light source does not light up after turning the power off and on, consult your dealer.
4	Perform maintenance or replacement of the filter. (➔ page 147)

*1 For the operating environment temperature of the projector, refer to “Operating temperature” (➔ page 165).

Chapter 7 Appendix

This chapter describes specifications for the projector.

Technical information

Using the PJLink function

The network function of this projector supports the PJLink class 1 and class 2, and setting of the projector or querying of the projector status can be performed from the computer using the PJLink protocol.

Note

- Setting the password of the administrator account (➔ page 107) is required for using the PJLink function of the projector.

PJLink commands

The following table lists the PJLink commands supported by the projector.

- x characters in tables are non-specific characters.

Class	Command	Control details	Parameter/ response string	Remark													
1	POWR	Power supply control	0 1	Standby Power on													
1	POWR?	Power supply status query	0 1 2	Standby Power on Preparing for switching off the projector													
1, 2	INPT	Input selection	11 12	COMPUTER1 COMPUTER2													
	INPT?	Input selection query	31 32 33 41 51	HDMI1 HDMI2 DIGITAL LINK ¹ MEMORY VIEWER NETWORK													
1	AVMT	Shutter control/audio output control	20 21 30 31	Mute function disabled Mute function enabled (muted) Shutter function disabled (shutter: open), mute function disabled Shutter function enabled (shutter: closed), mute function enabled (muted)													
	AVMT?	Shutter status query/ audio output status query	21 30 31	Shutter function disabled (shutter: open), mute function enabled (muted) Shutter function disabled (shutter: open), mute function disabled Shutter function enabled (shutter: closed), mute function enabled (muted)													
1	ERST?	Error status query	xxxxxx	<table border="1"> <tr> <td>1st byte</td> <td>Indicates fan errors, and returns 0 or 2.</td> <td rowspan="6"> <ul style="list-style-type: none"> • 0 = No error is detected • 1 = Warning • 2 = Error </td> </tr> <tr> <td>2nd byte</td> <td>Indicates light source errors, and returns 0 - 2.</td> </tr> <tr> <td>3rd byte</td> <td>Indicates temperature errors, and returns 0 - 2.</td> </tr> <tr> <td>4th byte</td> <td>Returns 0.</td> </tr> <tr> <td>5th byte</td> <td>Indicates filter errors, and returns 0 - 2</td> </tr> <tr> <td>6th byte</td> <td>Indicates other errors, and returns 0 - 2.</td> </tr> </table>	1st byte	Indicates fan errors, and returns 0 or 2.	<ul style="list-style-type: none"> • 0 = No error is detected • 1 = Warning • 2 = Error 	2nd byte	Indicates light source errors, and returns 0 - 2.	3rd byte	Indicates temperature errors, and returns 0 - 2.	4th byte	Returns 0.	5th byte	Indicates filter errors, and returns 0 - 2	6th byte	Indicates other errors, and returns 0 - 2.
1st byte	Indicates fan errors, and returns 0 or 2.	<ul style="list-style-type: none"> • 0 = No error is detected • 1 = Warning • 2 = Error 															
2nd byte	Indicates light source errors, and returns 0 - 2.																
3rd byte	Indicates temperature errors, and returns 0 - 2.																
4th byte	Returns 0.																
5th byte	Indicates filter errors, and returns 0 - 2																
6th byte	Indicates other errors, and returns 0 - 2.																
1	LAMP?	Light source status query	AAAAA X	AAAAA: Light source runtime X: 0 = Light source off, 1 = Light source on													
1, 2	INST?	Input selection list query	11 12 31 32 33 41 51	—													
1	NAME?	Projector name query	xxxxx	Returns the name set in the [NETWORK] menu → [PROJECTOR NAME].													
1	INF1?	Manufacturer name query	Panasonic	Returns manufacturer name.													

Class	Command	Control details	Parameter/ response string	Remark
1	INF2?	Model name query	PT-VMZ71 PT-VMZ61 PT-VMZ51 PT-VMZ51S PT-VMZ41 PT-VMW61 PT-VMW51	Returns model name.
1	INF0?	Other information queries	xxxxx	Returns information such as version number.
1	CLSS?	Class information query	2	Returns class for PJLink.
2	SNUM ?	Serial number query	xxxxxxxxx	Returns serial number.
2	SVER ?	Software version query	xxxxxxxxx	Returns version number.
2	INNM ?	Input name query	COMPUTER1 COMPUTER2 HDMI1 HDMI2 DIGITAL LINK *1 MEMORY VIEWER NETWORK	Returns input name.
2	IRES ?	Input signal resolution query	AAAAxBBBB	AAAA: Horizontal resolution BBBB: Vertical resolution
2	RRES ?	Recommended resolution query	1920 x 1200	Only for PT-VMZ71, PT-VMZ61, PT-VMZ51, PT-VMZ51S and PT-VMZ41
			1280 x 800	Only for PT-VMW61 and PT-VMW51
2	FILT ?	Filter runtime inquiry	xxxxx	Returns the runtime of the filter.
2	RFIL ?	Filter replacement model number inquiry	ET-RFV500	Returns the Replacement Filter Unit model number.
2	SVOL	Speaker volume	0	Decreases the volume.
			1	Increases the volume.
2	FREZ	Freeze control	0	Freeze function disabled
	FREZ ?	Freeze status query	1	Freeze function enabled (freeze)
2	LKUP	Link up notification	xx:xx:xx:xx:xx:xx	Notifies the MAC address when the PJLink communication becomes possible.
2	SRCH	Projector search	ACKN= xx:xx:xx:xx:xx:xx	The projector connected to the same network that can communicate with PJLink will respond with its MAC address.

*1 Not available for PT-VMZ51S and PT-VMZ41.

PJLink security authentication

A PJLink password for security authentication is required for PJLink command communication.

The PJLink password can be set from the [NETWORK] menu → [PJLink] → [PJLink PASSWORD] (➡ page 111) or from the [Set up password] page (➡ page 139) of the web control screen.

When using the PJLink commands without security authentication, set the PJLink password to blank. The factory default setting of PJLink password is blank.

- For specifications related to PJLink, visit the website of Japan Business Machine and Information System Industries Association.

URL <http://pjlink.jbmia.or.jp/english/>

Control commands via LAN

You can also control via the <DIGITAL LINK/LAN> terminal or <LAN> terminal by using the control command format via the <SERIAL IN> terminal.

For examples of the available commands, refer to “Control command” (➔ page 162).

Note

- Setting the password of the administrator account is required (➔ page 107) for sending and receiving the commands via LAN.

When connecting in protected mode

Connection method

This is the connection method when [NETWORK] menu → [NETWORK SECURITY] → [COMMAND PROTECT] is set to [ENABLE].

1) Obtain the IP address and port number (Initial set value = 1 024) of the projector and make a request for connection to the projector.

- You can obtain both the IP address and the port number from the menu screen of the projector.

IP address	Obtain from the [NETWORK] menu → [NETWORK STATUS].
Port No.	Obtain from the [NETWORK] menu → [NETWORK CONTROL] → [COMMAND PORT].

2) Check the response from the projector.

	Data section	Blank	Mode	Blank	Random number section	Termination symbol
Command example	“NTCONTROL” (ASCII string)	‘ ’ 0x20	‘1’ 0x31	‘ ’ 0x20	“ZZZZZZZ” (ASCII code hexadecimal number)	(CR) 0x0d
Data length	9 bytes	1 byte	1 byte	1 byte	8 bytes	1 byte

- Mode : 1 = Protect mode
- Example: Response during protect mode (random number section is undefined value)
“NTCONTROL 1 23181e1e” (CR)

3) Generate a 32-byte hash value from the following data using MD5 algorithm.

- “xxxxxx:yyyyy:zzzzzzz”

xxxxxx	User name of the administrator account
yyyyy	Password of the administrator account
zzzzzzz	8-byte random number obtained in Step 2)

Command data format

It is the data format used for sending and receiving commands.

■ Transmitted data

	Header			Data section	Termination symbol
Command example	Hash value “Connection method” (➔ page 157)	‘0’ 0x30	‘0’ 0x30	Control command (ASCII string)	(CR) 0x0d
Data length	32 bytes	1 byte	1 byte	Undefined length	1 byte

- Example: Transmission of power supply status acquisition command (hash value is calculated from the user name and password of the administrator account, and acquired random number)
“dbdd2dabd3d4d68c5dd970ec0c29fa6400QPW” (CR)

■ Received data

	Header		Data section	Termination symbol
Command example	'0' 0x30	'0' 0x30	Control command (ASCII string)	(CR) 0x0d
Data length	1 byte	1 byte	Undefined length	1 byte

- Example: The projector is powered on "00001" (CR)

■ Error response

	String	Details	Termination symbol
Message	"ERR1"	Undefined control command	(CR) 0x0d
	"ERR2"	Out of parameter range	
	"ERR3"	Busy state or no-acceptable period	
	"ERR4"	Timeout or no-acceptable period	
	"ERR5"	Wrong data length	
	"ERRA"	Password mismatch	
Data length	4 bytes	—	1 byte

Note

- The projector automatically disconnects from the network immediately after sending the command. Such specifications are made from the viewpoint of security, such as prevention of illegal operation of the projector by a malicious third party. To send commands continuously, make a request for network connection every time and send it. For details, see "Communication flow between the server and the client" (➔ page 159).

When connecting in non-protected mode

Connection method

This is the connection method when [NETWORK] menu → [NETWORK SECURITY] → [COMMAND PROTECT] is set to [DISABLE].

1) Obtain the IP address and port number (Initial set value = 1 024) of the projector and make a request for connection to the projector.

- You can obtain both the IP address and the port number from the menu screen of the projector.

IP address	Obtain from the [NETWORK] menu → [NETWORK STATUS].
Port No.	Obtain from the [NETWORK] menu → [NETWORK CONTROL] → [COMMAND PORT].

2) Check the response from the projector.

	Data section	Blank	Mode	Termination symbol
Command example	"NTCONTROL" (ASCII string)	' ' 0x20	'0' 0x30	(CR) 0x0d
Data length	9 bytes	1 byte	1 byte	1 byte

- Mode : 0 = Non-protect mode
- Example: Response during non-protect mode "NTCONTROL 0" (CR)

Command data format

It is the data format used for sending and receiving commands.

■ Transmitted data

	Header		Data section	Termination symbol
Command example	'0' 0x30	'0' 0x30	Control command (ASCII string)	(CR) 0x0d
Data length	1 byte	1 byte	Undefined length	1 byte

- Example: Transmission of power supply status acquisition command
"00QPW" (CR)

■ Received data

	Header		Data section	Termination symbol
Command example	'0' 0x30	'0' 0x30	Control command (ASCII string)	(CR) 0x0d
Data length	1 byte	1 byte	Undefined length	1 byte

- Example: The projector is in standby status
"00000" (CR)

■ Error response

	String	Details	Termination symbol
Message	"ERR1"	Undefined control command	(CR) 0x0d
	"ERR2"	Out of parameter range	
	"ERR3"	Busy state or no-acceptable period	
	"ERR4"	Timeout or no-acceptable period	
	"ERR5"	Wrong data length	
Data length	4 bytes	—	1 byte

Note

- The projector automatically disconnects from the network immediately after sending the command. Such specifications are made from the viewpoint of security, such as prevention of illegal operation of the projector by a malicious third party. To send commands continuously, make a request for network connection every time and send it. For details, see "Communication flow between the server and the client" (➔ page 159).

Communication flow between the server and the client

When sending / receiving commands via LAN, refer to the communication flow shown below.

Server: the projector

Client: the control device such as a computer

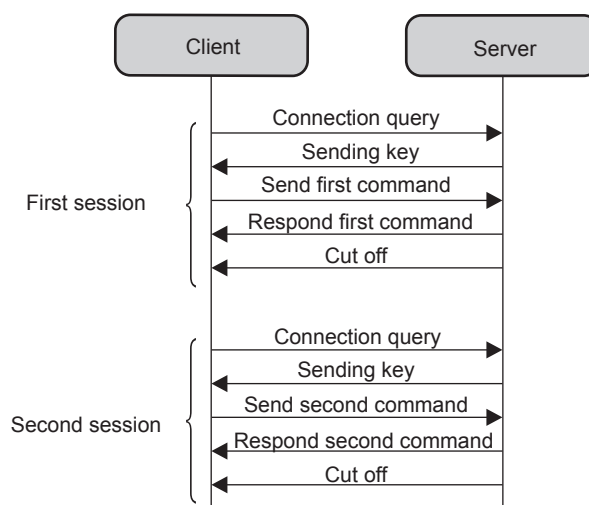

<SERIAL IN> terminal

The <SERIAL IN> terminal of the projector conforms with RS-232C so that the projector can be connected to and controlled from a computer.

Connection

● When connecting directly

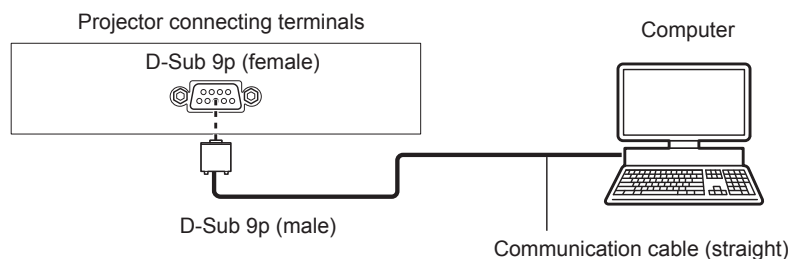

● When connecting with DIGITAL LINK compatible devices

(Not available for PT-VMZ51S and PT-VMZ41)

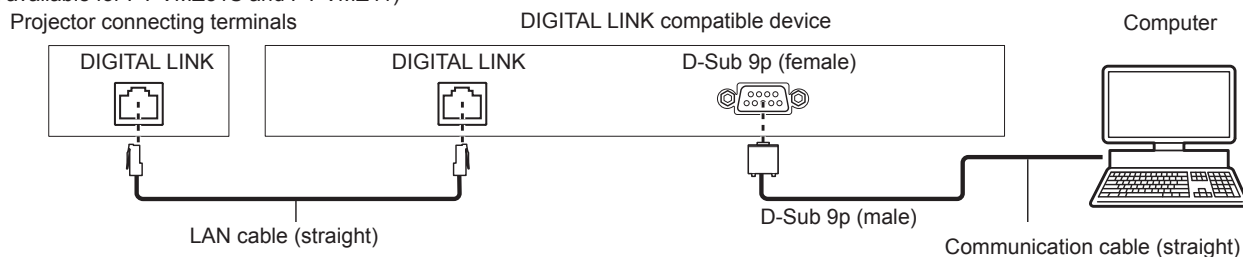

Note

- The destination of [RS-232C] (➔ page 93) must be set according to the connection method.
- When connecting by a DIGITAL LINK compatible device, set the [PROJECTOR SETUP] menu → [ECO MANAGEMENT] → [STANDBY MODE] (➔ page 92) to [NORMAL] to control the projector in standby mode.
When [STANDBY MODE] is set to [ECO], the projector cannot be controlled during standby.

Pin assignments and signal names

Outside view	Pin No.	Signal name	Details
	(1)	—	NC
	(2)	TXD	Transmitted data
	(3)	RXD	Received data
	(4)	—	NC
	(5)	GND	Earth
	(6)	—	NC
	(7)	CTS	Connected internally
	(8)	RTS	
	(9)	—	NC

Communication conditions (Factory default)

Signal level	RS-232C-compliant
Sync. method	Asynchronous
Baud rate	9 600 bps
Parity	None
Character length	8 bits
Stop bit	1 bit
X parameter	None
S parameter	None

Basic format

Transmission from the computer starts with STX, then the ID, command, parameter, and ETX are sent in this order. Add parameters according to the details of control.

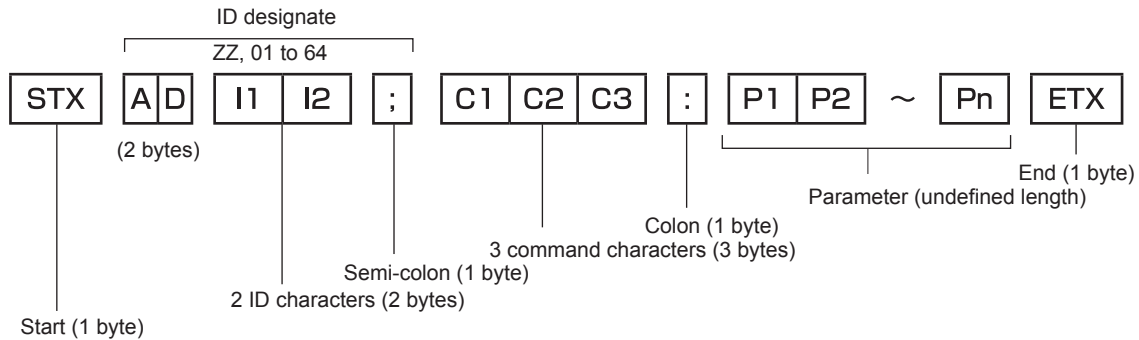

Basic format (has subcommands)

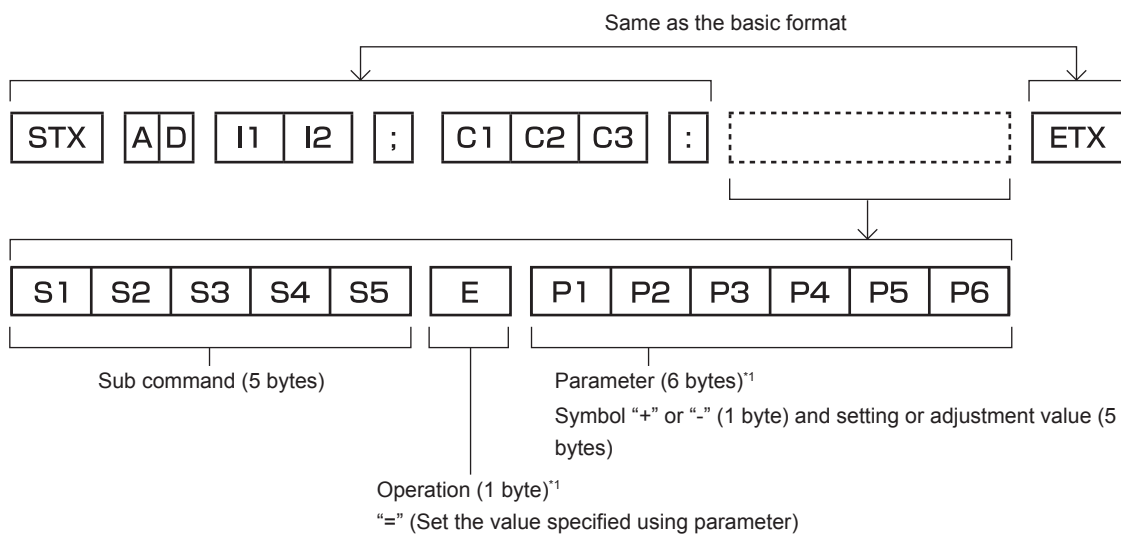

*1 When transmitting a command which does not need a parameter, an operation (E) and parameter are not necessary.

Attention

- If a command is transmitted after the light source starts illuminating, there may be a delay in response or the command may not be executed. Try sending or receiving any command after 60 seconds.
- When transmitting multiple commands, be sure to wait until 0.5 seconds has elapsed after receiving the response from the projector before sending the next command. When transmitting a command which does not need a parameter, a colon (:) is not necessary.

Note

- If a command cannot be executed, the "ER401" response is sent from the projector to the computer.
- If an invalid parameter is sent, the "ER402" response is sent from the projector to the computer.
- ID transmission in RS-232C supports ZZ (ALL) and 01 to 64.
- If a command is sent with a specified ID, a response will be sent to the computer only in the following cases.
 - It matches the projector ID
 - When [PROJECTOR ID] (➔ page 89) on the projector is [ALL]
- STX and ETX are character codes. STX shown in hexadecimal is 02, and ETX shown in hexadecimal is 03.

Cable specification

When connected to a computer

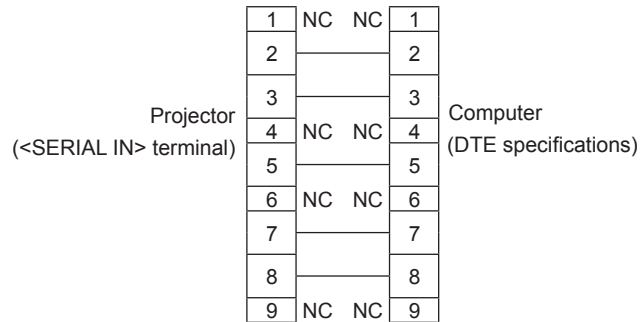

Control command

The following table lists the commands that can be used to control the projector using a computer.

■ **Projector control command**

Command	Details	Parameter/response string	Remark (parameter)
PON	Power on	—	To check if the power is on, use the “Power query” command.
POF	Power standby		
QPW	Power query	000 001	STANDBY Power on
IIS	Switching the input signal	RG1 RG2 HD1 HD2 DL1 MV1 NWP	COMPUTER1 COMPUTER2 HDMI1 HDMI2 DIGITAL LINK*1 MEMORY VIEWER NETWORK
Q\$L	Light source cumulative runtime query	—	Returned with 0 to 99999
OSH	Shutter control	0	Shutter function off (shutter open)
QSH	Shutter status query	1	Shutter function on (shutter closed)
Q\$\$	Light source condition query	0 1 2 3	Stand-by Light source ON control active Light source ON Light source OFF control active
VSE	Aspect ratio switch	1 2 5 6	NORMAL WIDE NATIVE FULL
QS1	Aspect ratio settings query	9 10	H FIT V FIT

*1 Not available for PT-VMZ51S and PT-VMZ41.

<COMPUTER 1 IN> terminal / <COMPUTER 2 IN> terminal pin assignments and signal names

Outside view	Pin No.	Signal names	Pin No.	Signal names
	①	R/P _R	⑨	+5 V
	②	G/Y	⑩	GND
	③	B/P _B	⑪	GND
	④	—	⑫	DDC data
	⑤	GND	⑬	HD/SYNC
	⑥	GND	⑭	VD
	⑦	GND	⑮	DDC clock
	⑧	GND		

Specifications

The specifications of this projector are as follows.

Display system		Translucent screen LCD panel x 3, 3 primary colors system	
Display device	Size of effective display area	1.63 cm (0.64") x 3 (aspect ratio 16 : 10)	
	Number of pixels	PT-VMZ71, PT-VMZ61, PT-VMZ51, PT-VMZ51S, PT-VMZ41	2 304 000 pixels (1 920 x 1 200 dots)
		PT-VMW61, PT-VMW51	1 024 000 pixels (1 280 x 800 dots)
Projection lens	Supplied projection lens	Zoom ratio: 1.6 x F = 1.6 to 2.12 f = 15.30 mm to 24.64 mm	
	Zoom	Manual	
	Focus	Manual	
	Lens shift	Manual (Horizontal/Vertical)	
	Changeable lens	No	
Light source		Laser diode	
Screen size		0.76 m (30") to 7.62 m (300")	
Light output^{*1}	PT-VMZ71	7 000 lm	When [PICTURE MODE] is set to [DYNAMIC], [LIGHT POWER] is set to [NORMAL], [DAYLIGHT VIEW] is set to [OFF], and [AUTO POWER SAVE] is set to [OFF]
	PT-VMZ61, PT-VMW61	6 200 lm	
	PT-VMZ51, PT-VMZ51S, PT-VMW51	5 200 lm	
	PT-VMZ41	4 500 lm	
Contrast ratio^{*1}		3 000 000:1	When [PICTURE MODE] is set to [DYNAMIC], [DYNAMIC CONTRAST] is set to [1]
Center to corner zone ratio^{*1}		85%	
Speaker		4.0 cm, round, x 1 10 W (monaural)	
Displayable scanning frequency	Horizontal	15.6 kHz to 91.1 kHz	
	Vertical	24 Hz to 100 Hz	
Input compatibility	HDMI signal input	Video signal resolution: 480i ² /576i ² to 4 096 x 2 160/30p Computer signal resolution: 640 x 400 to 1 920 x 1 200 (non-interlace) Dot clock frequency: 25 MHz to 297 MHz	
	DIGITAL LINK signal input	Video signal resolution: 480i ² /576i ² to 4 096 x 2 160/30p Computer signal resolution: 640 x 400 to 1 920 x 1 200 (non-interlace) Dot clock frequency: 25 MHz to 297 MHz	
	COMPUTER signal input	Video signal resolution: 480i/576i to 1 920 x 1 080 Computer signal resolution: 640 x 400 to 1 920 x 1 200 (non-interlace) Dot clock frequency: 13.5 MHz to 162 MHz	

*1 Measurement, measuring conditions, and method of notation all comply with ISO/IEC 21118:2020 international standards.

*2 Only for Pixel-Repetition signal (Dot clock frequency is 27.0 MHz)

Chapter 7 Appendix - Specifications

Connecting terminals	<HDMI IN 1> terminal <HDMI IN 2> terminal	HDMI x 2, HDCP compatible, Deep Color compatible Audio signal Linear PCM (sampling frequency: 48 kHz/44.1 kHz/32 kHz)	
	<DIGITAL LINK/LAN>*1 terminal	RJ-45 x 1, for network and DIGITAL LINK connections (HDBaseT™ compliant), PLink (class 2) compatible, 100Base-TX, HDCP compatible, Deep Color compatible	
	<LAN> terminal	RJ-45 x 1, for network connection, PLink (class 2) compatible, 10Base-T/100Base-TX	
	<COMPUTER 1 IN> terminal	High-density D-Sub 15 p (female) x 1 0.7 V [p-p] 75 Ω (SYNC ON GREEN: 1.0 V [p-p] 75 Ω) RGB signal SYNC/HD TTL high impedance, automatic positive/negative polarity compatible VD TTL high impedance, automatic positive/negative polarity compatible Y_BP_R signal Y: 1.0 V [p-p] including synchronization signal, P _B P _R : 0.7 V [p-p] 75 Ω	
	<COMPUTER 2 IN> terminal	High-density D-Sub 15 p (female) x 1 0.7 V [p-p] 75 Ω (SYNC ON GREEN: 1.0 V [p-p] 75 Ω) RGB signal SYNC/HD TTL high impedance, automatic positive/negative polarity compatible VD TTL high impedance, automatic positive/negative polarity compatible Y_BP_R signal Y: 1.0 V [p-p] including synchronization signal, P _B P _R : 0.7 V [p-p] 75 Ω	
	<AUDIO IN 1> terminal <AUDIO IN 2> terminal	M3 stereo mini jack x 2, 0.5 V [rms], input impedance 22 kΩ or more	
	<VARIABLE AUDIO OUT> terminal	M3 stereo mini jack x 1, monitor output and stereo compatible, 0 V [rms] to 2.0 V [rms] (variable), output impedance 2.2 kΩ or lower	
	<USB (VIEWER/WIRELESS/DC OUT)> terminal <SERIAL IN> terminal	USB connector (type A) x 1, for Memory Viewer function/ Wireless module (Model No.: AJ-WM50) connection/power supply (DC 5 V, maximum 2 A) D-Sub 9 p x 1, RS-232C compliant, for computer control	
Acoustic noise ²	PT-VMZ71	38 dB	When [LIGHT POWER] in [ECO MANAGEMENT] is set to [NORMAL] or [ECO].
	PT-VMZ61, PT-VMZ51, PT-VMZ51S, PT-VMZ41, PT-VMW61, PT-VMW51	36 dB	
	PT-VMZ71	28 dB	When [LIGHT POWER] in [ECO MANAGEMENT] is set to [QUIET]
	PT-VMZ61, PT-VMZ51, PT-VMZ51S, PT-VMZ41, PT-VMW61, PT-VMW51	26 dB	
Operating environment	Operating temperature	0 °C (32 °F) to 45 °C (113 °F) ^{3,4}	
	Operating humidity	20 % to 80 % (no condensation)	
Operation position		[FRONT/CEILING], [FRONT/DESK], [REAR/CEILING], [REAR/DESK]	
Power requirements		110 V ~ (110 V alternating current), 60 Hz (for Taiwan)	
		100 V - 240 V ~ (100 V - 240 V alternating current), 50 Hz/60 Hz (for other countries and regions)	
Rated current	PT-VMZ71	4.0 A (for Taiwan)	
		4.5 A - 1.9 A (for other countries and regions)	
	PT-VMZ61, PT-VMW61	3.5 A (for Taiwan)	
		3.9 A - 1.7 A (for other countries and regions)	
PT-VMZ51, PT-VMZ51S, PT-VMZ41, PT-VMW51	2.8 A (for Taiwan)		
	3.1 A - 1.3 A (for other countries and regions)		
Maximum power consumption	PT-VMZ71	420 W (The power consumption is 410 W at 200 V - 240 V.)	
	PT-VMZ61, PT-VMW61	370 W (The power consumption is 360 W at 200 V - 240 V.)	
	PT-VMZ51, PT-VMW51	305 W (The power consumption is 295 W at 200 V - 240 V.)	
	PT-VMZ51S, PT-VMZ41	300 W (The power consumption is 290 W at 200 V - 240 V.)	

*1 Not available for PT-VMZ51S and PT-VMZ41.

*2 Measurement, measuring conditions, and method of notation all comply with ISO/IEC 21118:2020 international standards.

*3 The projector cannot be used at an altitude of 2 700 m (8 858') or higher above sea level.

If the operating environment temperature exceeds the following value, the light output may be reduced to protect the projector.

- When using the projector at an altitude lower than 700 m (2 297') above sea level: 36 °C (97 °F)
- When using the projector at an altitude between 700 m (2 297') and 1 400 m (4 593') above sea level: 34 °C (93 °F)
- When using the projector at an altitude between 1 400 m (4 593') and 2 100 m (6 890') above sea level: 32 °C (90 °F)
- When using the projector at an altitude between 2 100 m (6 890') and 2 700 m (8 858') above sea level: 30 °C (86 °F)

*4 The projector's operating environment temperature should be within 0 °C (32 °F) to 40 °C (104 °F) when the optional wireless module (Model No.: AJ-WM50) is attached.

Chapter 7 Appendix - Specifications

Standby mode power consumption		Approx. 0.5 W		When [STANDBY MODE] is set to [ECO]	
		Approx. 15 W		When [STANDBY MODE] is set to [NORMAL] and [IN STANDBY MODE] of [AUDIO SETTING] is set to [OFF], DIGITAL LINK ^{*1} connection is not established, <USB (VIEWER/WIRELESS/DC OUT)> terminal is not in use, and [QUICK STARTUP] of [ECO MANAGEMENT] is set to [OFF]	
		PT-VMZ71, PT-VMZ61, PT-VMZ51, PT-VMW61, PT-VMW51	Approx. 50 W	When [STANDBY MODE] is set to [NORMAL], [IN STANDBY MODE] of [AUDIO SETTING] is set to [ON], DIGITAL LINK ^{*1} connection is established, <USB (VIEWER/WIRELESS/DC OUT)> terminal supplies power (2 A), and [QUICK STARTUP] of [ECO MANAGEMENT] is set to [OFF]	
		PT-VMZ51S, PT-VMZ41	Approx. 45 W		
		PT-VMZ71, PT-VMZ61	Approx. 95 W	When [STANDBY MODE] is set to [NORMAL], [IN STANDBY MODE] of [AUDIO SETTING] is set to [ON], DIGITAL LINK ^{*1} connection is established, <USB (VIEWER/WIRELESS/DC OUT)> terminal supplies power (2 A), and [QUICK STARTUP] of [ECO MANAGEMENT] is set to [ON]	
		PT-VMZ51	Approx. 90 W		
		PT-VMZ51S, PT-VMZ41, PT-VMW61	Approx. 85 W		
		PT-VMW51	Approx. 80 W		
Standard outside dimensions	Width	399 mm (15-23/32")			
	Height	133 mm (5-1/4") (with legs at shortest position)			
	Depth	348 mm (13-11/16")			
Weight^{*2}	PT-VMZ71		Approx. 7.0 kg (15.4 lbs.)		
	PT-VMZ61, PT-VMW61		Approx. 6.9 kg (15.2 lbs.)		
	PT-VMZ51, PT-VMZ51S, PT-VMZ41, PT-VMW51		Approx. 6.5 kg (14.3 lbs.)		
Outer case	Materials	Molded plastic			
	Color	White / Black			
Power cord length		India and North/Middle/South America: 3.0 m (118-1/8") Other countries or regions: 2.0 m (78-3/4")			
Laser Classification	Laser Class	Class 1 (IEC/EN 60825-1:2014)			
	Risk Group	Risk group 2 (IEC 62471-5:2015)			
Wireless LAN^{*3}	Compliance standards	IEEE802.11b/g/n			
	Transmission method	DSSS, OFDM			
	Frequency range (Channel)	2 412 MHz to 2 462 MHz (1 to 11ch)			
	Data transfer speed (Standard value)	IEEE802.11n	Maximum 144 Mbps		
		IEEE802.11g	Maximum 54 Mbps		
IEEE802.11b		Maximum 11 Mbps			
Encryption method	WPA2-PSK (AES)				
Remote control	Power requirements	DC 3 V (AAA/R03/LR03 battery x 2)			
	Operating range	PT-VMZ71, PT-VMZ61, PT-VMZ51, PT-VMW61, PT-VMW51	Within approx. 30 m (98'5") (when operated directly in front of signal receiver)		
		PT-VMZ51S, PT-VMZ41	Within approx. 20 m (65'7") (when operated directly in front of signal receiver)		
	Weight	PT-VMZ71, PT-VMZ61, PT-VMZ51, PT-VMW61, PT-VMW51	102 g (3.6 ozs.) (including batteries)		
		PT-VMZ51S, PT-VMZ41	63 g (2.22 ozs.) (including batteries)		
	Outside dimensions	PT-VMZ71, PT-VMZ61, PT-VMZ51, PT-VMW61, PT-VMW51	Width: 48 mm (1-7/8"), Height: 145 mm (5-23/32"), Depth: 27 mm (1-1/16")		
		PT-VMZ51S, PT-VMZ41	Width: 44 mm (1-23/32"), Height: 105 mm (4-1/8"), Depth: 20.5 mm (13/16")		

*1 Not available for PT-VMZ51S and PT-VMZ41.

*2 Average value. Weight varies for each product.

*3 To use the wireless LAN function with the projector, it is necessary to attach the optional Wireless Module (Model No.: AJ-WM50).

Note

- The model numbers of accessories and optional accessories are subject to change without prior notice.

Dimensions

Unit : mm (inch)

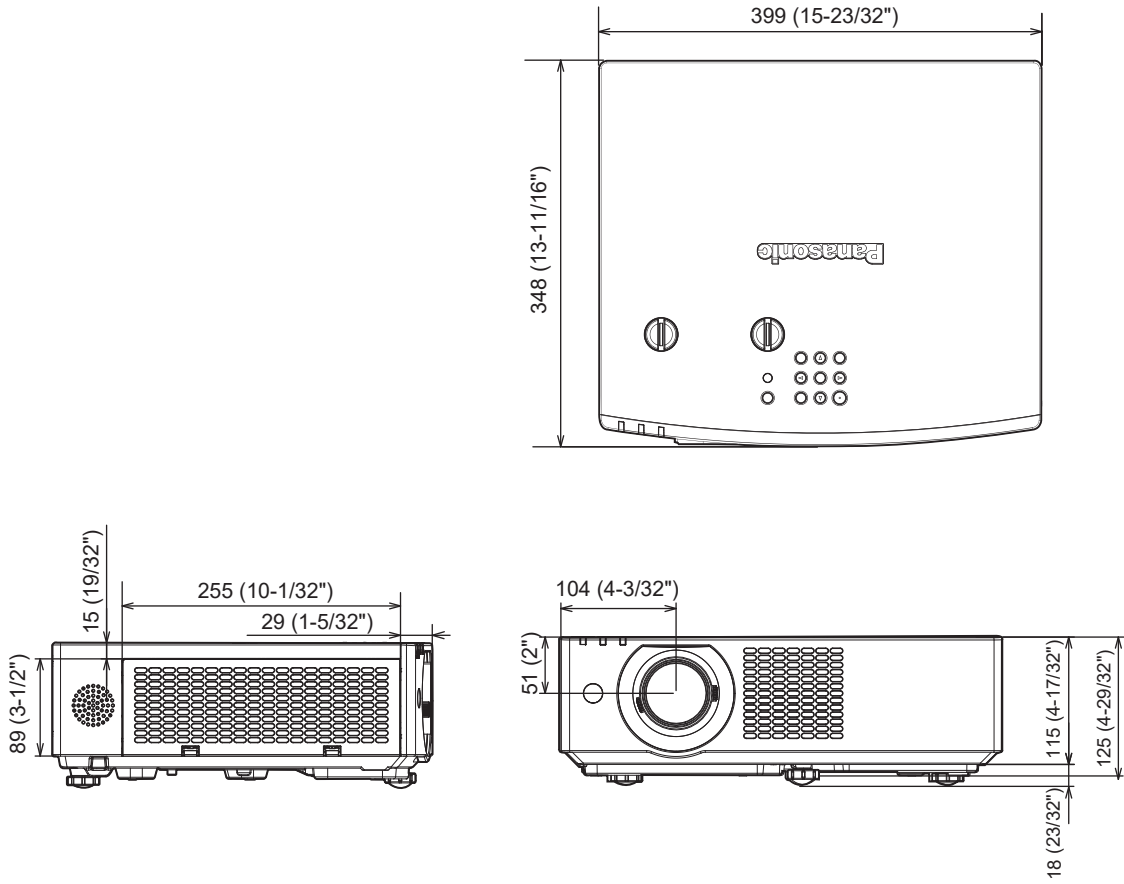

* Actual dimension may differ by product.

List of compatible signals

The following table specifies the type of signals compatible with the projectors.

- Symbols that indicate formats are as follows.
 - R : RGB
 - Y : YC_BC_R/YP_BP_R
 - H : HDMI, DIGITAL LINK
- Input corresponding to each item in the plug and play column is as follows.
 - COMPUTER: COMPUTER1 / COMPUTER2 input
 - HDMI: HDMI1 / HDMI2 input
 - DIGITAL LINK: DIGITAL LINK input

Signal type	Signal name	Display resolution (dots)	Scanning frequency		Dot clock frequency (MHz)	Format	Plug and play*1	
			H (kHz)	V (Hz)			COMPUTER	HDMI/DIGITAL LINK
Video signals	480/60i	720 x 480i	15.7	59.9	13.5	R/Y	—	—
	576/50i	720 x 576i	15.6	50.0	13.5	R/Y	—	—
	480/60i	720 (1 440) x 480i ²	15.7	59.9	27.0	H	—	—
	576/50i	720 (1 440) x 576i ²	15.6	50.0	27.0	H	—	—
	480/60p	720 x 480	31.5	59.9	27.0	R/Y/H	—	✓
	576/50p	720 x 576	31.3	50.0	27.0	R/Y/H	—	✓
	720/60p	1 280 x 720	45.0	60.0 ⁷	74.3	R/Y/H	—	✓
	720/50p	1 280 x 720	37.5	50.0	74.3	R/Y/H	—	✓
	1080/60i	1 920 x 1 080i	33.8	60.0 ⁷	74.3	R/Y/H	—	✓
	1080/50i	1 920 x 1 080i	28.1	50.0	74.3	R/Y/H	—	✓
	1080/24p	1 920 x 1 080	27.0	24.0 ⁷	74.3	R/Y/H	—	✓
	1080/24sF	1 920 x 1 080i	27.0	48.0 ⁷	74.3	R/Y/H	—	—
	1080/25p	1 920 x 1 080	28.1	25.0	74.3	R/Y/H	—	—
	1080/30p	1 920 x 1 080	33.8	30.0 ⁷	74.3	R/Y/H	—	—
	1080/60p	1 920 x 1 080	67.5	60.0 ⁷	148.5	R/Y/H	—	✓
	1080/50p	1 920 x 1 080	56.3	50.0	148.5	R/Y/H	—	✓
	3840 x 2160/24p	3 840 x 2 160	54.0	24.0 ⁷	297.0	H	—	✓
	3840 x 2160/25p	3 840 x 2 160	56.3	25.0	297.0	H	—	✓
	3840 x 2160/30p	3 840 x 2 160	67.5	30.0 ⁷	297.0	H	—	✓
	4096 x 2160/24p	4 096 x 2 160	54.0	24.0 ⁷	297.0	H	—	✓
4096 x 2160/25p	4 096 x 2 160	56.3	25.0	297.0	H	—	✓	
4096 x 2160/30p	4 096 x 2 160	67.5	30.0 ⁷	297.0	H	—	✓	
Computer signals	640 x 400/70	640 x 400	31.5	70.1	25.2	R/H	—	—
	640 x 400/85	640 x 400	37.9	85.1	31.5	R/H	—	—
	640 x 480/60	640 x 480	31.5	59.9	25.2	R/H	✓	✓
	640 x 480/67	640 x 480	35.0	66.7	30.2	R/H	—	—
	640 x 480/73	640 x 480	37.9	72.8	31.5	R/H	✓	✓
	640 x 480/75	640 x 480	37.5	75.0	31.5	R/H	✓	✓
	640 x 480/85	640 x 480	43.3	85.0	36.0	R/H	—	—
	800 x 600/56	800 x 600	35.2	56.3	36.0	R/H	✓	✓
	800 x 600/60	800 x 600	37.9	60.3	40.0	R/H	✓	✓
	800 x 600/72	800 x 600	48.1	72.2	50.0	R/H	✓	✓
	800 x 600/75	800 x 600	46.9	75.0	49.5	R/H	✓	✓
	800 x 600/85	800 x 600	53.7	85.1	56.3	R/H	—	—
	832 x 624/75	832 x 624	49.7	74.6	57.3	R/H	✓	✓
	1024x768/50 ⁶	1 024 x 768	39.6	50.0	51.9	R/H	—	—
	1024x768/60	1 024 x 768	48.4	60.0	65.0	R/H	✓	✓
	1024x768/70	1 024 x 768	56.5	70.1	75.0	R/H	✓	✓
	1024x768/75	1 024 x 768	60.0	75.0	78.8	R/H	✓	✓
	1024x768/82	1 024 x 768	65.5	81.6	86.0	R/H	—	—
	1024x768/85	1 024 x 768	68.7	85.0	94.5	R/H	—	—
	1024x768/100	1 024 x 768	81.4	100.0	113.3	R/H	—	—
1152 x 864/60	1 152 x 864	53.7	60.0	81.6	R/H	—	—	

Chapter 7 Appendix - Specifications

Signal type	Signal name	Display resolution (dots)	Scanning frequency		Dot clock frequency (MHz)	Format	Plug and play*1	
			H (kHz)	V (Hz)			COMPUTER	HDMI/DIGITAL LINK
Computer signals	1152 x 864/75	1 152 x 864	67.5	75.0	108.0	R/H	—	—
	1152 x 864/85	1 152 x 864	77.1	85.0	119.7	R/H	—	—
	1152 x 870/75	1 152 x 870	68.7	75.1	100.0	R/H	✓	✓
	1280 x 720/50	1 280 x 720	37.1	49.8	60.5	R/H	—	—
	1280 x 720/60	1 280 x 720	44.8	59.9	74.5	R/H	—	—
	1280 x 768/60 ⁶	1 280 x 768	47.7	60.0	80.1	R/H	—	—
	1280 x 768/60	1 280 x 768	47.8	59.9	79.5	R/H	—	—
	1280 x 768/75	1 280 x 768	60.3	74.9	102.3	R/H	—	—
	1280 x 768/85	1 280 x 768	68.6	84.8	117.5	R/H	—	—
	1280 x 800/50	1 280 x 800	41.3	50.0	68.0	R/H	—	—
	1280 x 800/60	1 280 x 800	49.7	59.8	83.5	R/H	✓*4	✓*4
	1280 x 800/75	1 280 x 800	62.8	74.9	106.5	R/H	—	—
	1280 x 800/85	1 280 x 800	71.6	84.9	122.5	R/H	—	—
	1280 x 960/60	1 280 x 960	60.0	60.0	108.0	R/H	—	—
	1280 x 1024/60 ⁶	1 280 x 1 024	64.0	60.0	108.0	R/H	—	—
	1280 x 1024/75	1 280 x 1 024	80.0	75.0	135.0	R/H	✓	✓
	1280 x 1024/85	1 280 x 1 024	91.1	85.0	157.5	R/H	—	—
	1366 x 768/50	1 366 x 768	39.6	49.9	69.0	R/H	—	—
	1366 x 768/60	1 366 x 768	47.7	59.8	85.5	R/H	—	—
	1366 x 768/60 ⁶	1 366 x 768	47.7	60.0	84.7	R/H	—	—
	1400 x 1050/60	1 400 x 1 050	65.3	60.0	121.8	R/H	—	—
	1400 x 1050/60 ⁶	1 400 x 1 050	65.2	60.0	122.6	R/H	—	—
	1400 x 1050/75	1 400 x 1 050	82.2	75.0	155.9	R/H	—	—
	1440 x 900/50 ⁶	1 440 x 900	46.3	50.0	87.4	R/H	—	—
	1440 x 900/60 ⁶	1 440 x 900	55.9	60.0	106.5	R/H	—	—
	1440 x 900/60	1 440 x 900	55.9	59.9	106.5	R/H	—	—
	1600 x 900/50 ⁶	1 600 x 900	46.3	50.0	97.0	R/H	—	—
	1600 x 900/60 ⁶	1 600 x 900	55.9	60.0	119.0	R/H	—	—
	1600 x 1200/60	1 600 x 1 200	75.0	60.0	162.0	R/H	✓	✓
	1680 x 1050/50	1 680 x 1 050	54.1	50.0	119.5	R/H	—	—
	1680 x 1050/60	1 680 x 1 050	65.3	60.0	146.3	R/H	—	—
	1680 x 1050/60 ⁶	1 680 x 1 050	65.2	60.0	147.1	R/H	—	—
1920 x 1080/50	1 920 x 1 080	55.6	49.9	141.5	R/H	—	—	
1920 x 1080/60 ³	1 920 x 1 080	66.6	59.9	138.5	R/H	—	—	
1920 x 1200/50	1 920 x 1 200	61.8	49.9	158.3	R/H	—	—	
1920 x 1200/60 ³	1 920 x 1 200	74.0	60.0	154.0	R/H	✓*5	✓*5	

*1 Signal with ✓ in the plug and play column is a signal described in the EDID (extended display identification data) of the projector. The signal that does not have ✓ in the plug and play column can also be input if it is described in the format column. The resolution may not be selected in the computer even if the projector is compatible with the signal that does not have ✓ in the plug and play column.

*2 Pixel-Repetition signal (dot clock frequency 27.0 MHz) only.

*3 VESA CVT-RB (Reduced Blanking)-compliant.

*4 Only for PT-VMW61 and PT-VMW51.

*5 Only for PT-VMZ71, PT-VMZ61, PT-VMZ51, PT-VMZ51S and PT-VMZ41.

*6 When inputting appropriate analog signal, it can be displayed by making the setting suitable for the signal from the [PICTURE] menu → [RGB-SYSTEM]. For digital signal, the [RGB-SYSTEM] setting is unnecessary.

*7 The signal with 1/1.001x vertical scanning frequency is also supported.

Note

- A signal with a different resolution is converted to the number of display dots. The number of display dots is as follows.
 - PT-VMZ71, PT-VMZ61, PT-VMZ51, PT-VMZ51S and PT-VMZ41: 1 920 x 1 200
 - PT-VMW61 and PT-VMW51: 1 280 x 800
- The “i” at the end of the resolution indicates an interlaced signal.
- When interlaced signals are connected, flickering may occur on the projected image.
- When the communication method of the DIGITAL LINK is set to [LONG REACH], the signals that the projector can receive are up to 1080/60p(148.5MHz).
- Even the above signals exist, some image signals recorded in special method may not be displayed.

Precautions for attaching the Ceiling Mount Bracket

- When installing the projector to a ceiling, be sure to use the specified optional Ceiling Mount Bracket.
Model No.: ET-PKL100H (for high ceilings), ET-PKL100S (for low ceilings), ET-PKV400B (Projector mount bracket)
- When installing the projector, attach the drop-prevention kit included with the Ceiling Mount Bracket.
- Ask a qualified technician to do the installation work such as mounting the projector on the ceiling.
- Panasonic Connect Co., Ltd. takes no responsibility for any damage to the projector resulting from use of a ceiling mount bracket not manufactured by Panasonic Connect Co., Ltd. or the inappropriate choice of location for installation, even if the warranty period of the projector has not expired.
- Unused products must be removed promptly by a qualified technician.
- Use a torque screwdriver or Allen torque wrench to tighten bolts to their specified tightening torques. Do not use electric screwdrivers or impact screwdrivers.
(Screw tightening torque: 1.25 ± 0.2 N·m)
- Read the Installation Instructions for the Ceiling Mount Bracket for details.
- The model numbers of accessories and optional accessories are subject to change without prior notice.

■ Screw hole specifications for ceiling mount (Bottom view)

Unit : mm (inch)

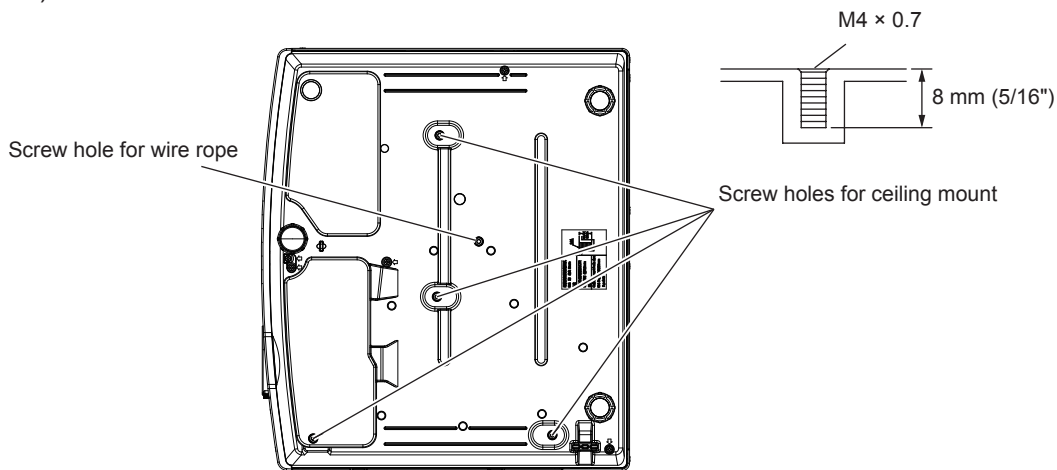

■ Screw hole dimensions for ceiling mount (Bottom view)

Unit : mm (inch)

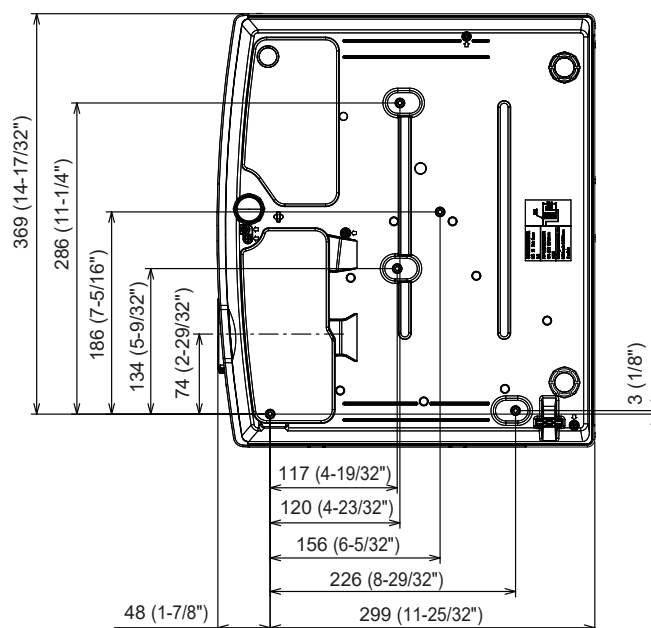

Index

- A**
- About Presenter Light 125
 - Accessing from the web browser 126
 - Accessories 25
 - <AC IN> terminal 30
 - [ADMINISTRATOR ACCOUNT] 107
 - [ADVANCED MENU] 71
 - Air filter unit 147
 - Application software 23
 - [ASPECT] 79
 - <ASPECT> button
 - Remote control 27, 29, 61
 - Attaching the lens cap 33
 - [AUDIO SETTING] 94
 - <AUTO SETUP> button
 - Projector body 31
 - Remote control 27, 28
 - [AUTO SETUP SETTING] 85
- B**
- [BACK COLOR] 85
 - Basic operations by using the remote control 57
 - [BRIGHTNESS] 69
- C**
- Cautions on use 23
 - <CEC> button 27, 29
 - [CLAMP POSITION] 80
 - [CLOCK PHASE] 78
 - [COLOR] 70
 - [COLOR TEMPERATURE] 70
 - <COMPUTER1/2> button
 - Remote control 27, 28
 - Connecting 40
 - Connecting the power cord 45
 - Connecting with wireless LAN 121
 - [CONTRAST] 69
 - [CONTROL DEVICE SETUP] 102
- D**
- [DIGITAL LINK MODE] 103
 - [DAYLIGHT VIEW] 71
 - <DEFAULT> button
 - Remote control 27, 29, 66
 - [DIGITAL CINEMA REALITY] 72
 - [DIGITAL LINK] 103
 - DIGITAL LINK 22
 - <DIGITAL LINK> button
 - Remote control 27
 - [DIGITAL LINK MENU] 104
 - [DIGITAL LINK SIGNAL LEVEL] 83
 - [DIGITAL LINK STATUS] 104
 - Dimensions 167
 - [DISPLAY OPTION] 82
 - Disposal 23
 - [DOT CLOCK] 78
 - [DYNAMIC CONTRAST] 72
 - <D.ZOOM> button
 - Remote control 27, 28, 59
- E**
- <ECO> button
 - Remote control 27, 62
 - [ECO MANAGEMENT] 90
 - <ENTER> button
 - Projector body 30
 - Remote control 27, 28
 - [ETHERNET TYPE] 103
- F**
- [FILTER COUNTER] 96
 - [FRAME LOCK] 79
 - <FREEZE> button
 - Remote control 27, 28, 58
 - <FUNCTION> button
 - Remote control 27, 29, 61
 - [FUNCTION BUTTON] 94
- G**
- [GAMMA] 70
- H**
- <HDMI1> button
 - Remote control 27, 28
 - <HDMI2> button
 - Remote control 27, 28
 - [HDMI CEC] 97
 - [HDMI SIGNAL LEVEL] 83
- I**
- <ID ALL> button
 - Remote control 27, 29, 63
 - <ID SET> button
 - Remote control 27, 29, 63
 - [INITIALIZE] 114
 - [INITIALIZE ALL] 99
 - [INITIAL START UP] 89
 - <INPUT SELECT> button
 - Projector body 30
 - Installation mode 35
- L**
- [LANGUAGE] 81
 - [LIGHT POWER] 91
 - Light source indicator <LIGHT> 146
 - List of compatible signals 168
- M**
- Main menu 66
 - Maintenance/replacement 147
 - [MEMORY VIEWER] 112
 - MEMORY VIEWER input 116
 - <MENU> button
 - Projector body 30
 - Remote control 27, 28
 - [MENU LOCK] 101
 - [MENU LOCK PASSWORD] 101
 - Menu Navigation 65
 - <MUTE> button
 - Remote control 27, 29, 57
- N**
- [NETWORK] 103
 - Network connection 119
 - [NETWORK CONTROL] 110
 - NETWORK input 118
 - [NETWORK SECURITY] 110
 - [NETWORK STATUS] 106
 - <NETWORK/USB> button
 - Remote control 27, 28
- O**
- <ON SCREEN> button
 - Remote control 27, 58
 - [ON-SCREEN DISPLAY] 82
 - Optional accessories 26
 - [OTHER FUNCTIONS] 87
 - [OVER SCAN] 79
- P**
- [PASSWORD] 100
 - [PASSWORD CHANGE] 100
 - [PICTURE] 69
 - [PICTURE MODE] 69
 - [PJLink] 111
 - PJLink protocol 155
 - [POSITION] 74
 - Power button
 - Projector body 30
 - Remote control 27, 28
 - Precautions for attaching the Ceiling Mount
 - Bracket 170
 - Precautions for use 19
 - Projecting 53
 - [PROJECTION METHOD] 90
 - Projector body 29
- [PROJECTOR ID] 89
- [PROJECTOR NAME] 106
- [PROJECTOR SETUP] 89
- [P-TIMER] 85
- <P-TIMER> button
 - Remote control 27, 28, 61
- Q**
- [QUICK STARTUP] 92
- R**
- Read this first! 4
 - [REALTIME KEYSTONE] 74
 - Remote control 27
 - [RGB-SYSTEM] 73
 - [RGB/Y_BP_R] / [RGB/Y_CB_R] 73
 - [RS-232C] 93
- S**
- <SCREEN ADJ> button
 - Remote control 27, 28, 59
 - [SCREEN ADJUSTMENT] 74
 - [SCREEN SETTING] 84
 - Security 21
 - [SECURITY] 100
 - [SELF TEST] display 153
 - <SERIAL IN> terminal 160
 - Setting up 35
 - [SHARPNESS] 70
 - [SHIFT] 77
 - <SHUTTER> button
 - Projector body 31
 - Remote control 27, 29
 - [SHUTTER SETTING] 84
 - [SIGNAL SEARCH] 85
 - Specifications 164
 - [STANDBY MODE] 92
 - [STARTUP LOGO] 84
 - [STATUS] 89
 - <STATUS> button
 - Remote control 27, 29, 62
 - Storage 23
 - Sub menu 67
 - Switching off the projector 52
 - Switching on the projector 47
- T**
- Temperature indicator <TEMP> 146
 - [TEST PATTERN] 96
 - <TEST PATTERN> button
 - Remote control 27, 62
 - [TEXT CHANGE] 101
 - [TEXT DISPLAY] 101
 - [TINT] 70
 - Troubleshooting 151
- U**
- [UNIFORMITY] 86
- V**
- <VOL-> button
 - Projector body 30
 - Remote control 27, 28
 - <VOL+> button
 - Projector body 30
 - Remote control 27, 28
- W**
- Web control 126
 - [WIRED LAN] 105

Disposal of Old Equipment and Batteries

Only for European Union and countries with recycling systems



These symbols on the products, packaging, and/or accompanying documents mean that used electrical and electronic products and batteries must not be mixed with general household waste. For proper treatment, recovery and recycling of old products and used batteries, please take them to applicable collection points in accordance with your national legislation.



By disposing of them correctly, you will help to save valuable resources and prevent any potential negative effects on human health and the environment.

For more information about collection and recycling, please contact your local authority.

Penalties may be applicable for incorrect disposal of this waste, in accordance with national legislation.



Note for the battery symbol (bottom symbol)

This symbol might be used in combination with a chemical symbol. In this case it complies with the requirement set by the Directive for the chemical involved.

Product Information (for Turkey only)

AEEE Yönetmeliğine Uygundur

Panasonic Connect Co., Ltd.

Web Site : <https://panasonic.net/cns/projector/>

© Panasonic Connect Co., Ltd. 2022

Panasonic Connect North America

Two Riverfront Plaza, Newark, NJ 07102

TEL: (877) 803 - 8492

Panasonic Canada Inc.

5770 Ambler Drive, Mississauga, Ontario L4W 2T3

TEL: (905) 624 - 5010

W0222JZ2033 -PT