

metabo®

PROFESSIONAL POWER TOOL SOLUTIONS

KHE 2245
KHE 2445
KHE 2645
KHE 2645 Q
KHE 2845
KHE 2845 Q



de Originalbetriebsanleitung 4
en Original instructions 8
fr Notice originale 12
nl Oorspronkelijke gebruiksaanwijzing 16
it Istruzioni originali 20
es Manual original 24
pt Manual original 28
sv Bruksanvisning i original 32
fi Alkuperäiset ohjeet 36
no Original bruksanvisning 40
da Original brugsanvisning 44
pl Instrukcja oryginalna 48
hu Eredeti használati utasítás 52

ru Оригинальное руководство по эксплуатации 56
hy Օրինակաբանի սկզբնական ուղեցույց 61
kk Пайдалану нұсқаулығының түпнұсқасы 65
ky Пайдалану боюнча нускаманың нукурасы 70
uk Оригінальна інструкція з експлуатації 75
cs Původní návod k používání 80
et Algupärane kasutusjuhend 84
lt Originali instrukcija 88
lv Instrukcijas oriģinālvalodā 92
ar 96 تعليمات التشغيل الأصلية

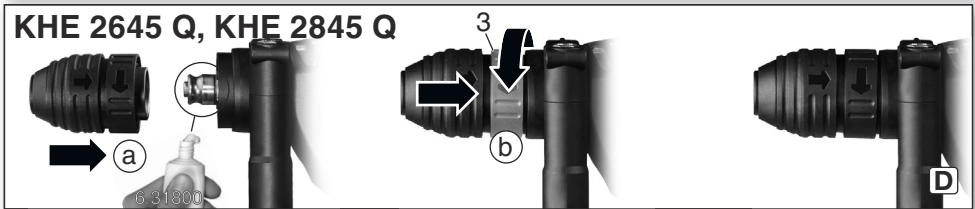
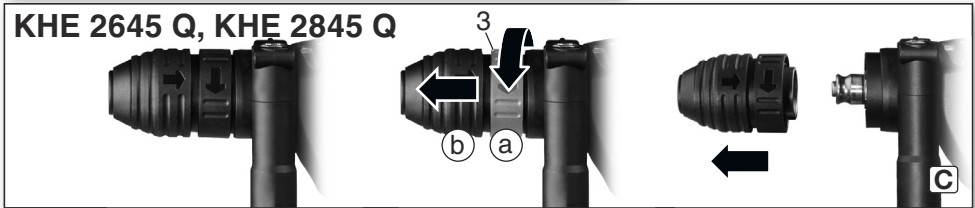
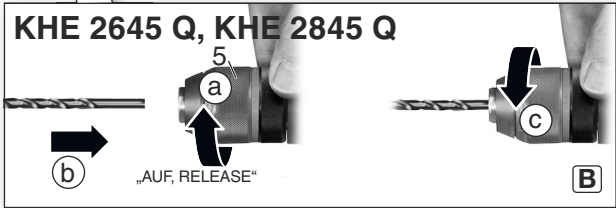
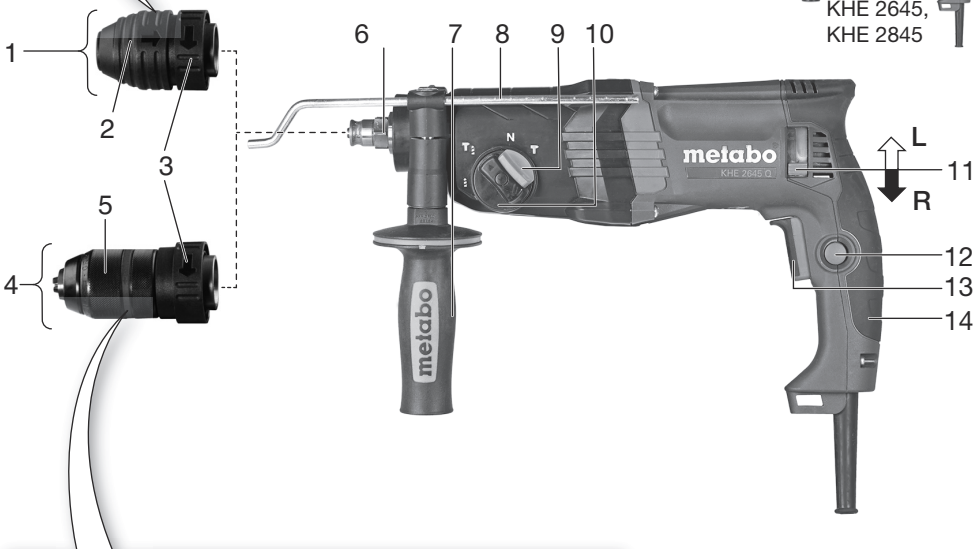
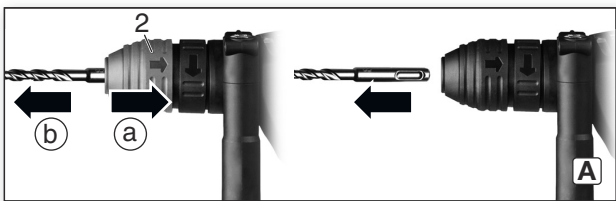

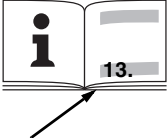
		KHE 2245 *1) Serial Number: 01708..	KHE 2445 *1) Serial Number: 01709..	KHE 2645 *1) Serial Number: 01710..	KHE 2645 Q *1) Serial Number: 01711..	KHE 2845 *1) Serial Number: 01739..	KHE 2845 Q *1) Serial Number: 01740..
		SDS-plus	SDS-plus	SDS-plus	SDS-plus	SDS-plus	SDS-plus
P₁	W	750	800 (110 V: 700)	850	850	880	880
P₂	W	354	378 (110V: 330)	385	385	400	400
n₁	/min	0-1500	0-1500	0-1150	0-1150	0-1200	0-1200
n₂	/min	1050	1050	850	830	850	830
s_{max}	/min bpm	4800	4800	4260	4260	4400	4400
W (EPTA 05/2009)	J	2,2	2,4	2,9	2,9	3,0	3,0
D₁	mm (in)	22 (7/8)	24 (1)	26 (1)	26 (1)	28 (1 3/32)	28 (1 3/32)
D₂	mm (in)	68 (2 11/16)	82 (3 7/32)	82 (3 7/32)	82 (3 7/32)	82 (3 7/32)	82 (3 7/32)
D₃	mm (in)	68 (2 11/16)	68 (2 11/16)	68 (2 11/16)	68 (2 11/16)	68 (2 11/16)	68 (2 11/16)
D₄	mm (in)	13 (1/2)	13 (1/2)	13 (1/2)	13 (1/2)	13 (1/2)	13 (1/2)
D₅	mm (in)	30 (1 3/16)	30 (1 3/16)	30 (1 3/16)	30 (1 3/16)	30 (1 3/16)	30 (1 3/16)
m	kg (lbs)	2,7 (5,95)	2,8 (6,17)	2,9 (6,39)	3,1 (6,83)	2,9 (6,39)	3,1 (6,83)
D	mm (in)	43 (1 11/16)	43 (1 11/16)	50 (2 1/16)	50 (2 1/16)	50 (2 1/16)	50 (2 1/16)
a_{h,HD}/K_{h,HD}	m/s²	12,8 / 1,5	12,8 / 1,5	16 / 1,5	16,5 / 1,5	16 / 1,5	16,5 / 1,5
a_{h,Cheq}/K_{h,Cheq}	m/s²	11,1 / 1,5	11,1 / 1,5	12,7 / 1,5	10,9 / 1,5	12,7 / 1,5	10,9 / 1,5
L_{pA}/K_{pA}	dB (A)	90 / 3	90 / 3	86 / 3	88 / 3	86 / 3	88 / 3
L_{WA}/K_{WA}	dB (A)	101 / 3	101 / 3	97 / 3	98 / 3	97 / 3	98 / 3

 *2) 2011/65/EU, 2006/42/EC, 2014/30/EU
 *3) EN 62841:2015, EN IEC 62841-2-6:2020+A11:2020, EN IEC 63000:2018

2022-03-02, Bernd Fleischmann
 Direktor Produktentstehung & Qualität (Vice President Product Engineering & Quality)
 *4) Metabowerke GmbH - Metabo-Allee 1 - 72622 Nuertingen, Germany

Original instructions

1. Declaration of Conformity

On our own responsibility, we hereby declare that this drilling and chisel hammer, identified by type and serial number *1), meets all relevant requirements of directives *2) and standards *3). Technical documents for *4) - see page 3.

For UK only:

UK We as manufacturer and authorized person to
CA compile the technical file, see *4) on page 3, hereby declare under sole responsibility that these drilling and chisel hammer, identified by type and serial number *1) on page 3, fulfill all relevant provisions of following UK Regulations S.I. 2016/1091, S.I. 2008/1597, S.I. 2012/3032 and Designated Standards EN 62841:2015, EN IEC 62841-2-6:2020+A11:2020, EN IEC 63000:2018.

2. Specified Conditions of Use



For your own protection and for the protection of your power tool, pay attention to all parts of the text that are marked with this symbol!



WARNING – Read the operating instructions to reduce the risk of injury.



WARNING – Read all safety warnings, instructions, illustrations and specifications provided with this power tool. Failure to follow all instructions listed below may result in electric shock, fire and/or serious injury.

Save all warnings and instructions for future reference. Always include these documents when passing on your power tool.

3. Special Safety Instructions

3.1 Safety instructions for all operations

- Wear ear protectors.** Exposure to noise can cause hearing loss.
- Use auxiliary handle(s), if supplied with the tool.** Loss of control can cause personal injury.
- Hold the power tool by insulated gripping surfaces, when performing an operation where the cutting accessory or fasteners may contact hidden wiring or its own cord.** Cutting accessory contacting a "live" wire may make exposed metal parts of the power tool "live" and could give the operator an electric shock.

3.2 Safety instructions when using long drill bits with rotary hammers

- Always start drilling at low speed and with the bit tip in contact with the workpiece.** At higher speeds, the bit is likely to bend if allowed to rotate freely without contacting the workpiece, resulting in personal injury.

b) Apply pressure only in direct line with the bit and do not apply excessive pressure. Bits can bend, causing breakage or loss of control, resulting in personal injury.

3.3 Further Safety instructions

Always work with the additional handle correctly installed.

Always hold the machine with both hands at the intended handles, take a secure stance and concentrate on the work.

Wear personal protective equipment and always wear safety glasses. Protective equipment such as dust mask, non-skid safety shoes, protective gloves, hard hat, or hearing protection used for appropriate conditions will reduce personal injuries.

Ensure that the spot where you wish to work is free of **power cables, gas lines or water pipes** (e.g. using a metal detector).

If the safety coupling responds, switch off the machine immediately.

Do not touch the rotating tool!

Secure the workpiece to prevent slipping or rotation (e.g. by securing with screw clamps).

Remove chips and similar material only with the machine at a standstill.

Caution must be exercised when driving screws into hard materials (driving screws with metric or imperial threads into steel)! The screw head may break or a high reverse torque may build up on the handle.

Pull the plug out of the socket before making any adjustments, changing tools, carrying out maintenance or cleaning.

Avoid inadvertent starts by always unlocking the switch when the plug is removed from the mains socket or whenever the power fails.

A damaged or cracked additional handle must be replaced. Never operate a machine with a defective additional handle.

Metabo S-automatic safety clutch.

When the safety clutch responds, switch off the machine immediately! If the tool jams or catches, the power supply to the motor is restricted. Due to the strong force which can arise, always hold the machine with both hands using the handles provided, stand securely and concentrate.

Reducing dust exposure:



WARNING - Some dust created by power sanding, sawing, grinding, drilling, and other construction activities contains chemicals known to cause cancer, birth defects or other reproductive harm. Some examples of these chemicals are:

- Lead from lead-based paints,
- crystalline silica from bricks and cement and other masonry products, and
- arsenic and chromium from chemically treated lumber.

Your risk from these exposures varies, depending on how often you do this type of work. To reduce your exposure to these chemicals: work in a well-ventilated area, and work with approved safety equipment, such as those dust masks that are specially designed to filter out microscopic particles.

This also applies to dust from other materials, such as some timber types (like oak or beech dust), metals, asbestos. Other known diseases are e.g. allergic reactions, respiratory diseases. Do not let dust enter the body.

Observe the relevant guidelines and national regulations for your material, staff, application and place of application (e.g. occupational health and safety regulations, disposal).

Collect the particles generated at the source, avoid deposits in the surrounding area.

Use suitable accessories for special work. In this way, fewer particles enter the environment in an uncontrolled manner.

Use a suitable extraction unit.

Reduce dust exposure with the following measures:

- do not direct the escaping particles and the exhaust air stream towards yourself or nearby persons or towards dust deposits,
- use an extraction unit and/or an air purifier,
- ensure good ventilation of the workplace and keep it clean using a vacuum cleaner. Sweeping or blowing stirs up dust.
- Vacuum or wash protective clothing. Do not blow, beat or brush protective gear.

4. Overview

See page 2.

- 1 SDS chuck
- 2 Tool lock
- 3 Chuck lock
- 4 Keyless chuck *
- 5 Sleeve keyless chuck *
- 6 Spindle *
- 7 Additional handle
- 8 Depth stop
- 9 Lock
- 10 Switch button (for changing the operating mode)
- 11 Rotation selector switch
- 12 Lock button
- 13 Trigger switch
- 14 Handle

* depending on equipment/not in scope of delivery

5. Initial Operation

 Before commissioning, check that the rated mains voltage and mains frequency stated on the type plate match your power supply.

 Always install an RCD with a maximum trip current of 30 mA upstream.

5.1 Assembly of the additional handle

 For safety reasons, always use the additional handle supplied.

Open the clamping ring by turning the side handle (7) anti-clockwise. Push the additional handle onto the collar of the machine. Insert the depth stop (8). Securely tighten the additional handle at the angle required for the application.

6. Use

6.1 Depth Stop Setting

Loosen the additional handle (7). Set the depth stop (8) to the desired drilling depth and retighten additional handle (7).

6.2 Switching On and Off

Press the trigger switch (13) to switch on the machine.

The speed can be changed using the trigger switch.

For continuous operation, the trigger button can be locked using the lock button (12). Press the trigger switch again to stop the machine.

 In continuous operation, the machine continues running if it is forced out of your hands. Therefore, always hold the machine with both hands using the handles provided, stand securely and concentrate.

6.3 Operating mode selection

Press the lock (9) and turn the thumbwheel (10).



Hammer drilling
(Set only when using the hammer chuck (1))





Chiselling
(Set only when using the hammer chuck (1))



Setting chisel position
Turn the chisel in the desired position. Then select "Chiselling" to secure the chisel and prevent it from twisting.



Drilling

 When a chisel is fitted, only operate the machine in the chiselling operating mode .

 Avoid levering with the machine when a chisel is fitted.

6.4 Selection of direction of rotation

 Only activate the rotation selector switch (11) when the motor has completely stopped.

Select direction of rotation:

R = clockwise rotation (for drilling, hammer drilling, chiselling, drive in screws)

L = anti-clockwise rotation (for the removal of screws)

6.5 Changing the chuck (KHE Q)

 Ensure a clean spindle (6) when changing the chuck. Apply a light coating of grease to the spindle. (Special grease: Order No.: 6.31800)

 Only attach the Metabo chuck provided.

Removing the chuck:

See page 2, fig. C.

- Turn the chuck lock (3) in the direction of the arrow until the stop (a) and remove chuck (b).

Replacing the chuck:

See page 2, fig. D.

- Put the chuck onto the spindle (6) (a).
- Turn the chuck lock (3) in the direction of the arrow (b) until the chuck can be pushed completely onto the spindle and release the chuck lock.
- Check to see that the chuck is properly seated.

Note: To prevent the spindle from rotating when the chuck is being changed, put the switch button (10) to chiselling .

6.6 Tool change with SDS chuck

 Before fitting, clean tool shank and apply special grease (accessories order no. 6.31800)! Use only SDS-Plus tools.

Inserting tools:

- Turn tool and insert until it engages. The tool is automatically locked.

Remove the tool:

See page 2, fig. A.

- Pull tool lock (2) backwards in direction indicated by arrow (a) and remove tool (b).

6.7 Tool change keyless chuck (KHE Q)

Use the keyless chuck when drilling without impact into metal, wood etc. and for driving in screws.

Clamp tool (see p.2, fig. B):

Turn sleeve (5) in direction "OPEN, RELEASE" (a). Insert tool as deeply as possible (b) and turn sleeve in the opposite direction, until any perceptible mechanical resistance is overcome (c). **Caution! The tool is not yet clamped!**

Continue to turn vigorously (**you must hear a "click"**), until you cannot turn any further - **only now** is the tool **safely** clamped.

Notes: The rattling that might be heard after opening the chuck (depending on the function) can be eliminated by turning the sleeve into the other direction.

With a soft tool shank, retightening may be required after a short drilling period.

7. Maintenance and Cleaning

Always keep the **spindle (6)** clean and grease it a bit. (Special grease: Order No.: 6.31800)

Cleaning the keyless chuck (4):

After prolonged use, hold the chuck vertically with the opening facing downwards and fully open and close it several times. The dust collected falls from

the opening. Regular use of cleaning spray on the jaws and jaw openings is recommended.

Vent slots:

The vent slots of the machine should be cleaned periodically.

8. Troubleshooting

If the trigger button (13) cannot be pressed, check, if the rotation selector switch (11) is completely in position R or L.

9. Accessories

Use only genuine Metabo accessories.

Use only accessories that fulfil the requirements and specifications listed in these operating instructions.

Fit accessories securely. If the machine is operated in a holder: secure the machine well. Loss of control can cause personal injury.

For a complete range of accessories, see www.metabo.com or the catalogue.

10. Repairs

 Repairs to electrical tools must **ONLY** be carried out by qualified electricians!

A defective mains cable must only be replaced with a special, original mains cable from metabo, which is available only from the Metabo service.

Contact your local Metabo representative if you have Metabo power tools requiring repairs. For addresses see www.metabo.com.

You can download a list of spare parts from www.metabo.com.

11. Environmental Protection

Observe national regulations on environmentally compatible disposal and on the recycling of disused machines, packaging and accessories.

 Only for EU countries: Never dispose of power tools in your household waste!
According to European Directive 2012/19/EU on Waste from Electric and Electronic Equipment and implementation in national law, used power tools must be collected separately and recycled in an environmentally-friendly manner.

12. Technical Data

Explanatory notes on the specifications on page 3. Changes due to technological progress reserved.

- P₁ = Rated input
- P₂ = Power output
- n₁ = no-load speed
- n₂ = on-load speed
- s_{max} = max. impact rate
- W = max. single impact force
- D₁ = drill-Ø concrete with hammer drill bits
- D₂ = drill-Ø masonry with core bits

- D_3 = drill-Ø concrete with core bits
 D_4 = drill-Ø steel
 D_5 = drill-Ø soft wood
 m = Weight without mains cable
 D = Collar diameter

Measured values determined in conformity with EN 62841.

Machine in protection class II

~ AC power

The technical specifications quoted are subject to tolerances (in compliance with relevant valid standards).



Emission values

These values make it possible to assess the emissions from the power tool and to compare different power tools. The actual load may be higher or lower depending on operating conditions, the condition of the power tool or the accessories used. Please allow for breaks and periods when the load is lower for assessment purposes. Arrange protective measures for the user, such as organisational measures based on the adjusted estimates.

Total vibration value (vector sum of three directions) determined in accordance with EN 62841:

$a_{h, HD}$ = Vibration emission value (hammer drilling into concrete)

$a_{h, Cheq}$ = Vibration emission value (chiselling)

$a_{h, D}$ = Vibration emission value (drilling into metal)

$K_{h, HD/Cheq/D}$ = Uncertainty (vibration)

Typical A-effective perceived sound levels:

L_{pA} = sound-pressure level

L_{WA} = Acoustic power level

K_{pA}, K_{WA} = Uncertainty

During operation the noise level can exceed 80 dB(A).



Wear ear protectors!