

kela

kela<sup>+</sup>

# KÜCHENWELT

Kitchen Concepts · Le Monde de la Cuisine

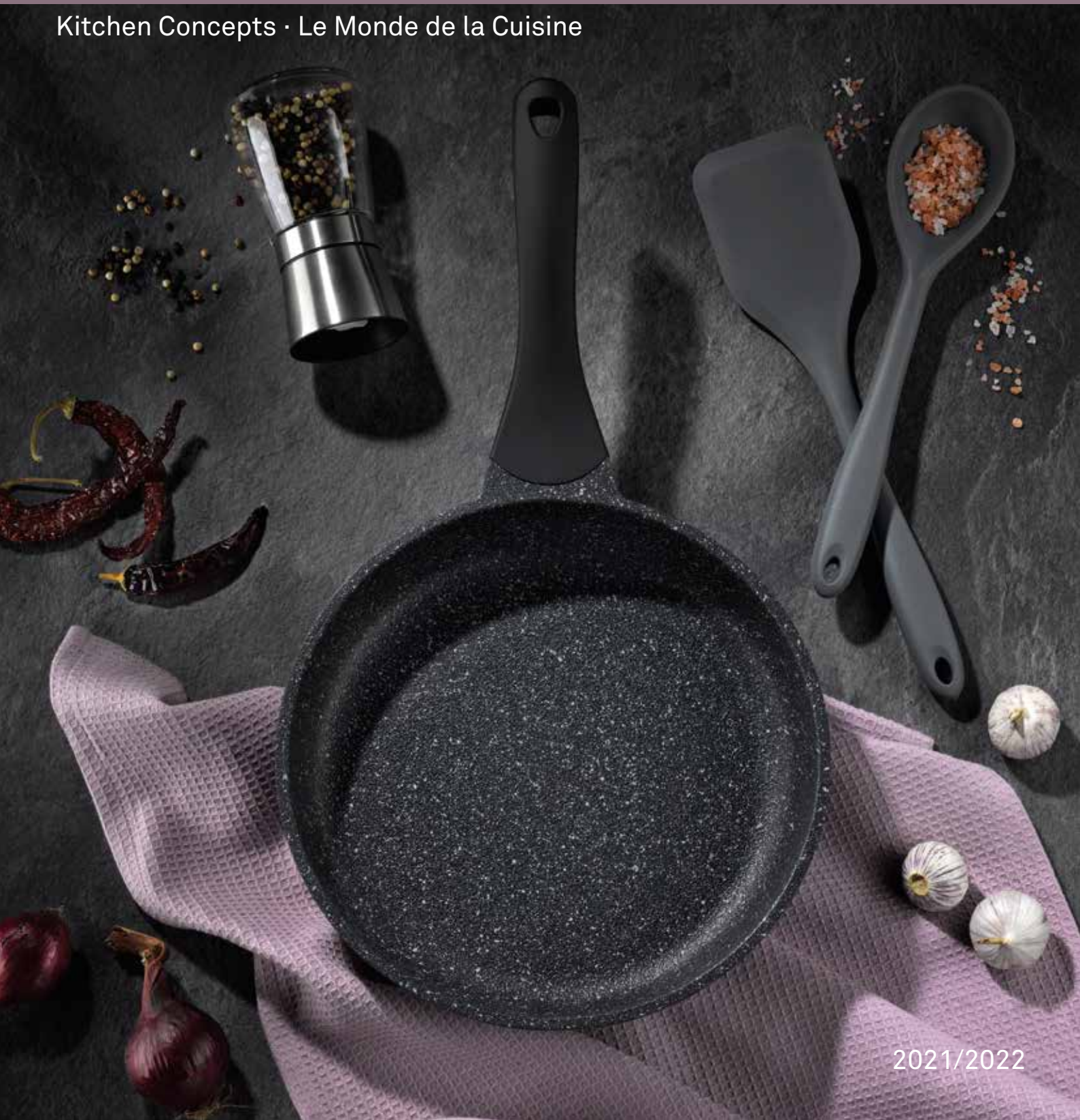

2021/2022

kela

# KÜCHENWELT

**Willkommen in der Themenwelt Küche** - kela präsentiert ein abgerundetes und innovatives Markensortiment rund um die Küche. Hochwertiges Kochgeschirr, nützliche Küchenhelfer, attraktive Küchentextilien, ein abverkaufsstarkes Produktangebot zum Thema Kochen am Tisch und trendige Ideen zur Tischkultur. Sichern Sie sich mit uns einen Vorsprung am Markt. Mit mehr als 1.800 Markenprodukten und erfolgreichen Verkaufskonzepten punktet kela weltweit beim Handel und beim Endverbraucher. Wir wünschen Ihnen viel Freude beim Stöbern in unserem neuen Küchen-Katalog.

Welcome to the world of kitchens - kela presents a rounded and innovative range of brand-name products for the kitchen. High-quality cookware, useful cooking utensils, attractive kitchen linens, a best-selling product range for cooking at the table and fashionable tableware ideas. Gain a competitive edge on the market with kela. With over 1800 brand-name products and successful sales concepts, kela hits the mark with retailers and consumers worldwide. We hope you enjoy browsing through our new catalogue.

Bienvenue dans le Monde Culinaire - La marque kela propose une gamme innovante et complète autour de la cuisine. Des accessoires de cuisson haut de gamme, des accessoires d'aide à la cuisson, du textile de cuisine, ainsi qu'une très large gamme dans le domaine de la cuisine conviviale « Cuisiner à Table ». Avec plus de 1800 produits ainsi que de nombreux concepts adaptés à chaque surface de vente, kela vous permet d'avoir un temps d'avance et se distingue dans le monde entier, chez les détaillants, ainsi qu'auprès du consommateur final. Nous vous souhaitons beaucoup de plaisir en feuilletant notre nouveau catalogue.



# Inhaltsverzeichnis · Contents · Contenu



## 97 Ordnen und Aufbewahren

Küchenrollenhalter  
Vorratsdosen  
Brotkästen  
Ordnungssysteme

## 107 Küchentextilien

Geschirr- und Reinigungstücher  
Topflappen  
Topfhandschuhe  
Schürzen  
Spülzubehör  
Abtropfmatten  
Tischsets  
Untersetzer



Seite **de**

### 04 Kochen & Braten

Pfannen  
Kochgeschirr  
Bräter  
Auflaufformen  
Wok  
Wasserkessel  
Zubehör

### 43 Vor- und Zubereiten

Küchenhelfer  
Reiben **NEW**  
Backutensilien  
Messer und Schneidegeräte  
Mühlen und Streuer  
Schüsseln und Siebe  
Schneidebretter

### 73 Servieren / Trinken

Espresso  
Kaffee  
Zubehör  
Tee  
Tassen  
Serviertablett  
Körbe, Schalen und Schüsseln

### 121 Kochen am Tisch

Raclettes  
Heiße Steine  
Fondues  
Käsefondues  
Schokofondues  
Rechauds  
Zubehör

### 135 Hygiene

### 139 Müll und Entsorgung

Treteimer

### 150 Schirmständer

### 151 Point of Sale

### 158 Index

### 160 AGB's



Page **en**

<b>04</b> <b>Cooking &amp; frying</b>	<b>107</b> <b>Kitchen textiles</b>
Frying pans	Dish towels and cleaning cloths
Cookware	Pot holders
Roasting pans	Oven gloves
Baking dishes	Aprons
Woks	Washing up
Kettles	Draining mats
Accessories	Place mats
	Mats
<b>43</b> <b>Preparation</b>	<b>121</b> <b>Cooking at the table</b>
Kitchen utensils	Raclette
Graters <b>NEW</b>	Hot stone
Baking utensils	Fondues
Knives and cutting implements	Cheese fondues
Grinders and dredgers	Chocolate fondues
Bowls and sieves	Rechauds
Cutting boards	Accessories
<b>73</b> <b>Serving / Drinking</b>	<b>135</b> <b>Hygiene</b>
Espresso	
Coffee	<b>139</b> <b>Waste and disposal</b>
Accessories	Pedal bins
Tea	
Cups	<b>150</b> <b>Umbrella stands</b>
Serving trays	
Baskets, bowls and dishes	<b>151</b> <b>Point of Sale</b>
<b>97</b> <b>Tidiness and storage</b>	<b>158</b> <b>Index</b>
Kitchen towel holders	
Storage jars	<b>160</b> <b>T&amp;Cs</b>
Bread bins	
Tidy systems	

Page **fr**

<b>04</b> <b>Cuire et griller</b>	<b>107</b> <b>Textiles de cuisine</b>
Poêles	Torchons de cuisine
Articles de cuisson	Maniques
Daubières et cocottes	Gants de cuisine
Plats à four	Tabliers
Wok	Accessoires d'évier
Bouilloires	Tapis d'évier
Accessoires	Sets de table
	Dessous de plat
<b>43</b> <b>Préparer</b>	<b>121</b> <b>Cuisine conviviale</b>
Outils de préparation	Raclettes
Râpes <b>NEW</b>	Pierre chaude
Ustensiles de pâtisserie	Fondues
Couteaux et ustensiles de découpe	Fondues à fromage
Moulins et saupoudreuses	Fondues à chocolat
Bols et passoirs	Réchauds
Planches à découper	Accessoires
<b>73</b> <b>Servir</b>	<b>135</b> <b>Hygiène</b>
Espresso	
Café	<b>139</b> <b>Poubelles</b>
Accessoires	Poubelles à pédale
Thé	
Tasses	<b>150</b> <b>Porte-parapluies</b>
Plateaux de service	
Corbeilles et coupes	<b>151</b> <b>Point de vente</b>
<b>97</b> <b>Ranger</b>	<b>158</b> <b>Index</b>
Porte essuie-tout	
Boîtes de conservation	<b>160</b> <b>CGV</b>
Boîtes à pain	
Systèmes de rangement	



# Materialkunde · Material science · Présentation des matériaux utilisés

**Edelstahl**  
Stainless steel · Inox

## Scharfes Anbraten und Kochen

Äußerst robust und nahezu unverwundlich. Extreme Hitze oder Temperaturschock beim Ablöschen macht diesem Material nichts aus. Pflegeleicht und brillant.

## Searing

Extremely tough and virtually indestructible to use. Stresses, like extreme heat or thermal shocks during quenching, are not a problem for this material. Easy-care and shiny.

## Saisir à feu vif

Extrêmement robuste et presque indestructible à l'usage. Les sollicitations extrêmes telles que de très hautes températures et même les chocs thermiques n'ont aucune action sur cette matière. D'entretien facile et brillant.

**Gusseisen**  
Cast iron · Fonte

## Schmoren und scharfes Anbraten

Einzigartige Wärmekapazität. Gleichmäßige Wärmeverteilung und Wärmespeicherung aufgrund der Dicke des Materials. Für hohe Temperaturen geeignet.

## Braising and searing

Extremely robust, tremendously good heat retention and heat distribution, withstands very high levels of heat. Saves time and energy.

## Mijoter et saisir à feu vif

Très robuste, excellente accumulation et répartition de la chaleur permettant des températures très élevées. Gain de temps et d'énergie.

**Eisen**  
Iron · Fer

## Scharfes Anbraten

Sehr robust. Natürliche Antihafteffekt durch Einbrennen vor Gebrauch. Ideal für schnelles Anbraten und Bräunen bei hohen Temperaturen. Das Bratgut wird außen kross und innen saftig und zart. Gute Wärmekapazität. Verträgt extrem hohe Hitze.

## Searing

Extremely robust, scratch-resistant, heats up quickly, withstands extremely high levels of heat and has excellent heat transfer. The patina, which forms gradually, is your guarantee for a unique frying and taste experience and provides a natural protective layer.

## Saisir à feu vif

Très robuste, résistant aux rayures, chauffe très rapidement, supporte des températures très élevées et assure une excellente répartition de la chaleur. La patine qui se forme peu à peu, garantit un plaisir exceptionnel aux amateurs de viande saisie et une couche de protection naturelle.

**Aluguss**  
Cast aluminium  
Fonte d'aluminium

## Schonendes und fettarmes Braten

Gute Wärmeaufnahme und optimale Wärmeverteilung. Sehr energieeffizient. Gesundes und fettfreies Braten möglich.

## For healthy and low-fat frying

Good heat absorption and optimum heat distribution, therefore extremely energy-efficient. The high-quality coating provides for healthy and fat-free frying.

## Une cuisson saine et pauvre en matière grasse

Très bonne absorption et répartition optimale de la chaleur, d'où une excellente efficacité énergétique.

**Aluminium**  
Aluminium forged  
Aluminium forgé

## Schonendes und fettarmes Braten

Gute Wärmeaufnahme und optimale Wärmeverteilung. Sehr energieeffizient. Gesundes und fettfreies Braten möglich.

## For healthy and low-fat frying

Good heat absorption and optimum heat distribution, therefore extremely energy-efficient. The high-quality coating provides for healthy and fat-free frying.

## Une cuisson saine et pauvre en matière grasse

Très bonne absorption et répartition optimale de la chaleur, d'où une excellente efficacité énergétique.



Kochen und Braten · Cookware · Accessoires de cuisson

# KOCHFREUDE



**Mit fundiertem Know-how und der Begeisterung für schöne Produkte setzt kela Maßstäbe in Sachen Qualität, Funktion und Design.** Die Qualität beginnt mit der Auswahl der richtigen Materialien, geht über verschiedene Prüfverfahren zur Qualitätssicherung und endet bei der sorgfältigen Verarbeitung. Die Kochgeschirre von kela sind für alle Herdarten geeignet, auch für Induktion.

**You can never go wrong with kela when it comes to cooking, frying and enjoying your food.**

kela sets the standard in quality, functionality and design with its in-depth knowledge and expertise and an enthusiasm for beautiful products. Quality starts with the selection of the materials used, through different testing processes and ends with careful workmanship. for all types of cooker, including induction hobs.

**Cuisiner, braiser et déguster.** Par son savoir et son enthousiasme pour de beaux produits, kela est très exigeant sur la qualité, la fonction et le design de ses collections. Le processus de fabrication commence par le choix du matériau adapté, suivi de tests très exigeants et se termine par une grande qualité de fabrication. Les accessoires de cuisson kela sont compatibles tous feux y compris induction.

# Stella Nova

Aluguss · Cast aluminium · Fonte d'aluminium



## Super krosse und geschmacksintensive Bratergebnisse

Eine speziell entwickelte, neuartige Oberflächenstruktur mit kleinen Vertiefungen in der Oberfläche garantiert krosse und geschmacksintensive Bratergebnisse.

## Ultra-crispy and full-flavoured frying results

A specially developed innovative surface structure with small indentations in the surface guarantees crispy and full-flavoured fried food.

## Pour un résultat savoureux, croustillant et fondant à la fois.

Une structure de surface en relief 3D innovante spécialement développée pour garantir une cuisson parfaite et maîtrisée.



### Oil-Control-System + hochwertige Antihafbeschichtung

Durch die Vertiefungen in der Oberfläche nimmt die Oberflächengröße zu – dies ermöglicht ein geschmacksintensives und krosses Bratergebnis. Eine moderne, hochwertige Antihafbeschichtung sorgt für Komfort beim Kochen und Reinigen.

### Oil Control System + high-grade non-stick coating

The indentations in the surface increase the surface area, resulting in even more full-flavoured and crispy fried food. A high-grade, modern non-stick coating ensures that the cookware can be conveniently cleaned.

### Oil Control System + revêtement anti-adhérent de haute qualité

La structure en relief de la surface permet d'obtenir une cuisson maîtrisée, plus croustillante et plus savoureuse des aliments. Le revêtement titane anti-adhérent de dernière technologie extrêmement résistant aux rayures et à l'usure offre un grand confort de cuisson et de nettoyage.





Stella Nova

Krosse & softe Bratergebnisse  
mit nur einer Pfanne



GERMAN  
DESIGN  
AWARD  
WINNER  
2020



# Stella Nova



10,5 cm

**Kochtopf 20 cm Ø 2,2 L**  
Covered saucepot · Faitout

1 - 4 

**12218** 4025457122187



11 cm

**Kochtopf 24 cm Ø 3,5 L**  
Covered saucepot · Faitout

1 - 4 

**12219** 4025457122194



8 cm

**Stielkasserolle 16 cm Ø, 1 L**  
Casserole with handle

Casserole à manche

1 - 6 

**12225** 4025457122255



9 cm

**Servierpfanne 32 cm Ø, 5,0 L**  
Serving pan · Sauteuse

1 - 4 

**12226** 4025457122262



4,5 cm

**Grill- und Paellapfanne 36 cm Ø**  
Grilling and paella pan

Poêle à griller et à paella

1 - 4 

**12221** 4025457122217



0-260°

3 cm

**Grillplatte 29 x 23 cm**

Flat griddle pan · Planche à griller

1 - 4 

**12220** 4025457122200





**Bratpfanne 20 cm Ø**  
Frying pan · Poêle

1	-	6	📦
<b>12215</b>	4025457122156		



**Bratpfanne 24 cm Ø**  
Frying pan · Poêle

1	-	6	📦
<b>12216</b>	4025457122163		



**Bratpfanne 28 cm Ø**  
Frying pan · Poêle

1	-	6	📦
<b>12217</b>	4025457122170		



**Bratpfanne 32 cm Ø**  
Frying pan · Poêle

1	-	6	📦
<b>12224</b>	4025457122248		



**Crêpe-Pfanne 32 cm Ø**  
Crêpe pan · Crêpière

1	-	6	📦
<b>12223</b>	4025457122231		



# Kerros

Aluguss · Cast aluminium · Fonte d'aluminium



## Fettarmes Kochen und Braten

Die mit Keramik verstärkte 3-schichtige Antihftbeschichtung ermöglicht besonders fettreduziertes Kochen und Braten. Außergewöhnliches Preis-/ Leistungsverhältnis.

## Low-fat cooking and frying

The ceramic-reinforced 3-layer non-stick coating guarantees exceptionally low-fat cooking and frying. Outstanding value for money.

## Cuisson à faible teneur en matières grasses.

Le revêtement anti-adhérent à trois couches, renforcé en particules de céramique est idéal pour une cuisson pauvre ou sans matières grasses. Un rapport qualité/prix exceptionnel.



### Greblon® Antihftbeschichtung deutsche Technologie

Die keramisch verstärkte 3-schichtige Antihftbeschichtung weist perfekte Antihfteigenschaften und beste Abriebbeständigkeit auf. Greblon® Antihftbeschichtungen aus dem Hause Weilburger.

### Greblon® non-stick coating – German technology

The ceramic-reinforced 3-layer non-stick coating boasts perfect non-stick properties and outstanding abrasion resistance. Greblon® non-stick coatings from Weilburger.

### Revêtement anti-adhérent Greblon®

Technologie allemande. Le revêtement anti-adhérent à 3 couches renforcé par de la céramique présente des propriétés anti-adhérentes parfaites et une meilleure résistance à l'abrasion. Les revêtements anti-adhérents Greblon® de Weilburger.



Für ein ernährungsbewusstes,  
fettarmes Kochen



# Kerros



**Fleischtopf 16 cm Ø 1,0 L**  
Covered saucepot · Faitout

1	-	6	📦
<b>11549</b>	4025457115493		



**Fleischtopf 20 cm Ø 1,7 L**  
Covered saucepot · Faitout

1	-	6	📦
<b>11550</b>	4025457115509		



**Fleischtopf 24 cm Ø 3,2 L**  
Covered saucepot · Faitout

1	-	6	📦
<b>11552</b>	4025457115523		



**Servierpfanne 32 cm Ø 5,0 L**  
Serving pan · Sauteuse

1	-	4	📦
<b>11554</b>	4025457115547		



**Servierpfanne 36 cm Ø 7,0 L**  
Serving pan · Sauteuse

1	-	4	📦
<b>11555</b>	4025457115554		



**Wok 32 cm Ø 4,0 L**  
Wok · Wok

1	-	6	📦
<b>15157</b>	4025457151576		



**Aromaknopf –**  
zum Verfeinern des Bratgutes  
Lid with aroma knob  
Couvercle avec bouton arôme



**Feuerfester Deckel –**  
auch als Auflaufform verwendbar  
Fire-proof lid –  
Can also used as a baking dish  
Couvercle résistant au feu –  
Utilisable comme plat à four



**Bräter 8,0 L**  
Roasting tray · Cocotte à braiser

1	-	4	📦
<b>15153</b>	4025457151538		
Aromaknopf · Aroma knob · Bouton arôme			



**Servierpfanne 28 x 28 cm 6,0 L**  
Serving pan · Sauteuse

1	-	4	📦
<b>11553</b>	4025457115530		
Aromaknopf · Aroma knob · Bouton arôme			

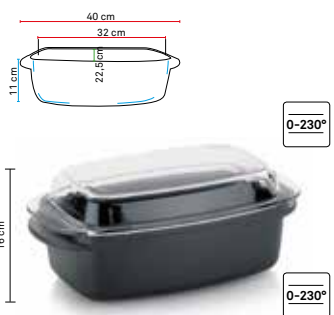

**Rechteck-Bräter 4,5 L**  
Rectangular roasting tray  
Cocotte à braiser rectangulaire

1	-	2	📦
<b>15152</b>	4025457151521		

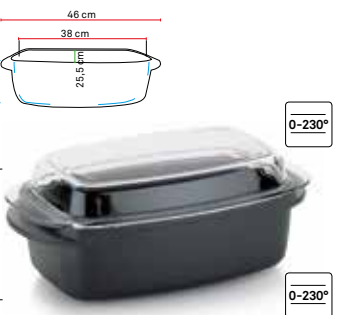

**Rechteck-Bräter 6,5 L**  
Rectangular roasting tray  
Cocotte à braiser rectangulaire

1	-	2	📦
<b>11563</b>	4025457115639		





**Bakelitgriff mit Aufhängeöse**  
 Bakelite handle  
 Manche Bakélite avec accroche de suspension



**Bratpfanne 18 cm Ø**  
 Frying pan · Poêle

1 - 6   
**11560** 4025457115608



**Bratpfanne 20 cm Ø**  
 Frying pan · Poêle

1 - 6   
**11561** 4025457115615



**Bratpfanne 24 cm Ø**  
 Frying pan · Poêle

1 - 6   
**15150** 4025457151507



**Bratpfanne 28 cm Ø**  
 Frying pan · Poêle

1 - 6   
**15151** 4025457151514



**Bratpfanne 32 cm Ø**  
 Frying pan · Poêle

1 - 6   
**15154** 4025457151545



**Schmorpfanne 24 cm Ø 1,9 L**  
 Stewing pan · Sauteuse

1 - 6   
**11567** 4025457115677



**Schmorpfanne 28 cm Ø 2,3 L**  
 Stewing pan · Sauteuse

1 - 6   
**11568** 4025457115684



**Crêpe-Pfanne 28 cm Ø**  
 Crêpe pan · Crêpière

1 - 6   
**15155** 4025457151552



**Grill-Eckpfanne 28 x 28 cm**  
 Square griddle pan · Poêle à griller

1 - 6   
**15156** 4025457151569

2 Ausgüsse · 2 Spouts · 2 Becs verseur



**Grillplatte 30 x 24 cm**  
 Flat griddle pan · Planche à griller

1 - 6   
**11564** 4025457115646



## Schonendes und fettarmes Braten

Das Original, mit echten Steinpartikeln. Braten wie auf Naturstein.  
3-schichtige Antihafbeschichtung.

## For healthy and low-fat frying

The original material, with real particles of stone.  
Like frying on natural stone. 3-layer non-stick coating.

## Une Cuisson saine et pauvre en matière grasse

L'Originale, avec particules de pierre. Cuire comme sur de la pierre naturelle. Revêtement anti adhésif . 3 couches.



**STONELINE**

**Antihafbeschichtung**

Non-stick coating  
Revêtement anti-adhésif

**Allherdboden**

Universal base  
Fond tous feux



0-180°



**Bratpfanne 16 cm Ø**  
Frying pan · Poêle

1 - 12 **16370** 4025457163708



**Bratpfanne 20 cm Ø**  
Frying pan · Poêle

1 - 6 **15474** 4025457154744



**Bratpfanne 24 cm Ø**  
Frying pan · Poêle

1 - 6 **15475** 4025457154751



**Bratpfanne 28 cm Ø**  
Frying pan · Poêle

1 - 6 **15476** 4025457154768

### Stoneline® Pflegetipp

Vor dem ersten Gebrauch empfehlen wir das Kochgeschirr mit etwas Wasser und einem milden Spülmittel gründlich auszuwaschen. Nach dem Trocknen mit einem Papierküchentuch einige Tropfen Speiseöl auf der Beschichtung verteilen. Bei der weiteren Nutzung können Sie auf den Einsatz von Fett oder Öl verzichten.

### Stoneline® Care hints

We recommend thoroughly washing the cookware with a little water and a mild detergent before using for the first time. Then use a paper towel to rub a few drops of edible oil onto the coating. There is then no need to use fat or oil when using the cookware in future.

### Conseil d'entretien Stoneline®

Avant d'utiliser la batterie de cuisine pour la première fois, nous vous recommandons de la laver soigneusement avec un peu d'eau et un détergent doux. Ensuite, étalez quelques gouttes d'huile de cuisson sur le revêtement avec un essuie-tout en papier. Pour une utilisation ultérieure, vous pouvez renoncer à l'utilisation de graisse ou d'huile!

Stoneline®

Braten wie auf  
Naturstein



# Calido glatt

Gusseisen · Cast iron · Fonte



## Perfekt für langsames Schmoren

Gusseisenbräter sind exzellente Wärmespeicher. Durch die gute Hitzeverteilung und -speicherung ist langsames Schmoren möglich. Die Gerichte werden dadurch besonders zart und hervorragend im Geschmack. Einfache Reinigung dank der glatten Emaille-Beschichtung. Induktionsgeeignet.

## Perfect for slow braising

Slow braising is possible, thanks to the good heat distribution and retention. Food remains tender and with exceptional flavour. Simple to clean, thanks to the smooth enamel coating. Suitable for induction hobs.

## Parfait pour le mijotage

Grâce à la bonne diffusion et la répartition parfaite de la chaleur, il est possible d'effectuer un mijotage lent. Cela rend les plats particulièrement tendres et excellents en goût. Convient parfaitement à l'induction.



### Handliche Griffe

Practical handles  
Poignées ergonomiques

### Innen: helle, glatte Emaille-Beschichtung

Bright, smooth enamel coating on the inside  
Intérieur: clair, revêtement émaillé lisse

### Außen: glatte Emaille-Beschichtung Rotverlauf

Smooth enamel coating on the outside  
Enamel coating  
Revêtement émaillé

### Allherdboden

Universal base  
Fond tous feux

### Größenangabe im Deckel

Dimensions inside the lid  
Indication de capacité

### Deckelknopf aus massivem Edelstahl

Stainless steel knob  
Bouton en acier inoxydable

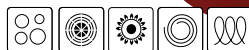

## Gusseisen mit glatter Emaille

Eine Emaille-Beschichtung garantiert einfaches Anbraten und Reinigen. Gusseisen verfügt über eine sehr gute Wärmeleitfähigkeit und -speicherung bis an den Topfrand. Dank der Wärmespeicherung ist das Kochgeschirr perfekt zum Servieren geeignet.

## Cast iron with smooth enamel

An enamel coating guarantees simple searing and cleaning. Cast iron has excellent heat conductivity and retention right to the very edge of the pot. The cookware is perfect for serving, thanks to its excellent heat retention.

## Fonte avec émail lisse

La fonte a une très bonne conductivité thermique et une bonne rétention de la chaleur jusqu'au bord de la cocotte. Grâce à la rétention de chaleur, les ustensiles de cuisine sont parfaits pour le service et conservent les aliments à bonne température. Un revêtement émaillé garantit également un nettoyage et un entretien facile.





**Bräter rund 21 cm Ø, 2,5 L**  
Roasting tray round · Cocotte ronde

1	-	2	📦
<b>11940</b>	4025457119408		
Rot/Beige · Red/Beige · Rouge/Beige			



**Bräter rund 24 cm Ø, 4,0 L**  
Roasting tray round · Cocotte ronde

1	-	2	📦
<b>11941</b>	4025457119415		
Rot/Beige · Red/Beige · Rouge/Beige			



**Bräter rund 26 cm Ø, 5,0 L**  
Roasting tray round · Cocotte ronde

1	-	2	📦
<b>11948</b>	4025457119484		
Rot/Beige · Red/Beige · Rouge/Beige			

Es muss nicht immer Braten sein. Auch Bolognesesoße, Lasagne oder Eintöpfe werden hier zum Geschmackserlebnis.

It doesn't always have to be a roast. Bolognese sauce, lasagne, stews and casseroles are transformed into veritable taste sensations.

Parfaite pour toutes les préparations. Retrouvez la saveur d'un rôti fondant ou d'une sauce bolognaise maison.



**Bräter oval 33 x 26 cm, 6,5 L**  
Roasting tray oval · Cocotte ovale

-	-	1	📦
<b>11942</b>	4025457119422		
Rot/Beige · Red/Beige · Rouge/Beige			



**Bräter oval 36 x 29 cm, 9,5 L**  
Roasting tray oval · Cocotte ovale

-	-	1	📦
<b>11943</b>	4025457119439		
Rot/Beige · Red/Beige · Rouge/Beige			



**Wok 36 cm Ø, 4 L**  
Wok · Wok

1	-	2	📦
<b>11947</b>	4025457119477		
Rot/Schwarz · Red/Black · Rouge/Noir			
Glasdeckel Glass lid · Couverture en verre			

**Innen raue Emaille-Beschichtung**

Enamel coating on the inside  
Revêtement extérieur émaillé

# Calido rau

Gusseisen · Cast iron · Fonte

## Zum Backen, Schmoren & scharfen Anbraten

Die raue Oberfläche fördert die volle Entfaltung der Brataromen. Gerichte aus einem Gusseisenbräter erhalten durch das langsame und gleichmäßige Schmoren einen fantastischen Geschmack. Die raue Emaille-Beschichtung innen verleiht den Gerichten durch die größere Oberfläche einen noch intensiveren Geschmack. Induktionsgeeignet.

## Perfect for baking, braising and searing

The rough surface encourages the roasting flavours to fully develop. Slow braising guarantees fantastic flavour. Suitable for induction hobs.

## Pour cuire, braiser et frire

La surface légèrement rugueuse accentue le développement des arômes. Une cuisson lente apporte une saveur remarquable. Convient pour l'induction.



## Gusseisen mit rauer Emaille

Die spezielle Oberfläche fördert die Entfaltung der Brataromen und verleiht den Speisen einen intensiven Geschmack. Durch den Gebrauch bildet sich durch Öl und Fett eine natürliche Patina. Die Hitze verteilt sich bei Gusseisen gleichmäßig bis an den Topfrand. Dank hervorragender Wärmespeicherung eignet sich die Serie perfekt zum Servieren und hält die Speisen lange warm.

## Cast iron with rough enamel

The special surface encourages the roasting flavours to develop, lending dishes an intense flavour. A natural patina is formed by oil and fat through using the cookware. With cast iron, the heat is distributed evenly right to the very edge of the pot. Thanks to its exceptional heat retention, the range is perfect for serving and keeping food warm.

## Fonte avec émail brut

La surface spéciale favorise le développement des arômes et donne aux aliments, un goût intense. A l'usage, une patine naturelle est formée par l'huile et la graisse. Avec la fonte, la chaleur est répartie uniformément jusqu'au bord de la cocotte. Grâce à une excellente rétention de la chaleur, la série est parfaite pour servir et garder au chaud.



Besondere Entfaltung der Brataromen durch die raue Oberfläche



**Bräter rund 21 cm Ø, 2,5 L**  
Roasting tray round · Cocotte ronde  
1 - 2

---

**12470** 4025457124709  
Schwarz · Black · Noir



**Bräter rund 24 cm Ø, 4,0 L**  
Roasting tray round · Cocotte ronde  
1 - 2

---

**12471** 4025457124716  
Schwarz · Black · Noir



**Bräter rund 26 cm Ø, 5,0 L**  
Roasting tray round · Cocotte ronde  
1 - 2

---

**12472** 4025457124723  
Schwarz · Black · Noir



**Bräter oval 33 x 26 cm, 6,5 L**  
Roasting tray oval · Cocotte ovale  
- - 1

---

**12473** 4025457124730  
Schwarz · Black · Noir



**Bräter oval 36 x 29 cm, 9,5 L**  
Roasting tray oval · Cocotte ovale  
- - 1

---

**12474** 4025457124747  
Schwarz · Black · Noir



**Wok 36 cm Ø, 4 L**  
Wok · Wok  
1 - 2

---

**12475** 4025457124754  
Schwarz · Black · Noir

**NEW**



Glasdeckel  
Glass lid · Couvreclre en verre



# Angus

Gusseisen · Cast iron · Fonte

## Für scharfes Anbraten und einen intensiveren Geschmack

Gusseisen mit einer rauen Emaille-Beschichtung eignet sich hervorragend zum krossen Anbraten bei hohen Temperaturen. Induktionsgeeignet.

## Perfect for searing and a more intensive flavour

Cast iron with rough enamel coating. For crispy searing at high temperatures. Suitable for induction hobs.

## Pour une friture intense et un goût plus prononcé.

La fonte avec un revêtement d'émail brut est excellente pour les fritures croustillantes à haute température. Convient pour l'induction.



NEW



### Pfanne aus einem Guss

One-piece pan  
Poêle en une seule fonte

0-300°

### Wandstärke

Wall thickness  
Épaisseur de paroi

3,4 mm

### Allherdboden

Universal base  
Fond tous feux



Bratpfanne 24 cm Ø  
Frying pan · Poêle

1 - 2   
11133 4025457111334

Bratpfanne 28 cm Ø  
Frying pan · Poêle

1 - 2   
11134 4025457111341

### Gusseisen mit rauer Emaille

Die spezielle Oberfläche fördert die Entfaltung der Brataromen und verleiht den Speisen einen intensiven Geschmack. Durch das Einbrennen von Ölen und Fetten beim Gebrauch bildet sich eine natürliche Patina. Die Hitze verteilt sich bei Gusseisen gleichmäßig bis an den Rand.

### Cast iron with rough enamel

The special surface encourages the roasting flavours to develop, lending dishes an intense flavour. A natural patina is formed by "seasoning" by oils and fats through use. With cast iron, the heat is distributed evenly right to the very edge.

### Fonte avec émail brut

La surface spéciale favorise le développement des arômes de friture et apporte aux aliments une saveur intense. A l'usage, il se forme une patine naturelle. Avec la fonte, la chaleur est répartie uniformément jusqu'au bord.



### Genietetes ergonomischer Griff

Riveted ergonomic handle  
Poignée ergonomique rivetée

Edelstahl  
Stainless steel · Inox

0-300°

### Wandstärke

Wall thickness  
Épaisseur de paroi

2 mm

### Allherdboden

Universal base  
Fond tous feux



Bratpfanne 24 cm Ø

Frying pan · Poêle

1 - 6

11616 4025457116162

Bratpfanne 28 cm Ø

Frying pan · Poêle

1 - 6

11617 4025457116179

Klassische Eisenpfanne für eine knusprige Oberfläche und ein saftiges Inneres  
kela Eisenpfannen aus Karbonstahl – lange Lebensdauer und hoch erheizbar.  
Induktionsgeeignet.

Traditional iron frying pan for crispy outsides and tender insides  
The patina that forms makes the frying pans even better with every use.  
Suitable for induction hobs.

Poêle naturelle en fer pour une cuisson croustillante et savoureuse  
A chaque utilisation, les poêles se patinent et permettent une saisie  
optimale des aliments. Convient pour l'induction.



### Eisenpfanne

Eisenpfannen von kela sind aus Karbonstahl hergestellt und bestehen zu 99 % aus Eisen. Der hohe Eisenanteil ist lebensmittel- und umweltfreundlich. Aufgrund des Materials weisen die Pfannen eine lange Lebensdauer auf. Durch die sich bildende Patina werden die Pfannen mit jedem Gebrauch besser.

### Iron frying pans

kela iron frying pans are produced from carbon steel consisting of 99 % iron. This makes our frying pans naturally beautiful, food-safe and environmentally friendly, at the same time giving them a long service life.

### Les poêles en fer

kela sont fabriquées à partir d'acier carbone et sont composées à 99 % de fer. Très adapté à l'usage alimentaire, il est naturel et permet une longue durée de vie.

# Rhino voreingebrannt

Eisen · Iron · Fer

**Geschmacksintensive Bratergebnisse und unverwüstlich**  
Die gleichmäßige Fettverteilung unter dem Bratgut sorgt für perfekte Entfaltung der Röstaromen.

**Full-flavoured frying results and indestructible**  
The even distribution of fat under the fried food encourages the roasting flavours to fully develop.

**Une poêle à frire indestructible et qui révèle un goût intense à chaque cuisson.** La répartition uniforme de la graisse sous les aliments assure un développement parfait des arômes.



**Eisenpfanne voreingebrannt**  
Die durchdachte Berg- und Talstruktur ermöglicht dem Öl durch die Grate zu fließen und dort zu verbleiben. Für ein Kochen und Braten mit weniger Fett. Die Farbe der Pfanne entsteht durch die Vorbehandlung – einem speziellen Einbrennverfahren. Ein Einbrennen vor dem ersten Gebrauch ist dadurch hinfällig.

**Pre-seasoned iron frying pan**  
The well thought-out corrugated structure of the base allows the oil to flow through the burrs and remain there, enabling you to cook and fry with less oil. The colour of the frying pan results from its pre-treatment – a special seasoning process. There is therefore no need to season the frying pan before using for the first time.

**Poêle en fer structurée et pré-traitée**  
Excellentes propriétés anti-adhérentes. Le fond non-lisse permet à l'huile de se répartir homogènement. Il n'est donc pas nécessaire de la culotter avant la première utilisation. Pour une cuisson saine avec peu de matière grasse.

**NEW**



**Genieteteter Griff aus Gusseisen**

Riveted handle  
Poignée rivetée

0-300°

**Wandstärke**

Wall thickness  
épaisseur de paroi



**Allherdboden**

Universal base  
Fond tous feux

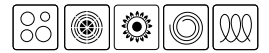

**Bratpfanne 20 cm Ø**  
Frying pan · Poêle

1 - 6

12600 4025457126000



**Bratpfanne 24 cm Ø**  
Frying pan · Poêle

1 - 6

12601 4025457126017



**Bratpfanne 28 cm Ø**  
Frying pan · Poêle

1 - 6

12602 4025457126024



## Fergus voreingebrannt

Eisen · Iron · Fer

Die Elegante mit einer besonders großen Bratfläche  
Genietet, ergonomischer Edelstahlgriff. Induktionsgeeignet.

The masculine pan, with a black, pre-treated surface  
Riveted, ergonomic stainless steel handle. Suitable for induction hobs.

La Masculine avec son fond noir prétraité  
Poignée en acier inoxydable ergonomique rivetée. Compatible induction.



5 cm		5,5 cm	
<b>Bratpfanne 28 cm Ø</b> Frying pan · Poêle		<b>Bratpfanne 30 cm Ø</b> Frying pan · Poêle	
1 - 6		1 - 6	
12305 4025457123054		12306 4025457123061	

### Eisenpfanne voreingebrannt

Die Farbe der Pfanne entsteht durch die Vorbehandlung – einem speziellen Einbrennverfahren. Ein Einbrennen vor dem ersten Gebrauch ist dadurch hinfällig.

### Pre-seasoned iron frying pan

The colour of the frying pan results from its pre-treatment – a special seasoning process. There is therefore no need to season the frying pan before using for the first time.

### Poêle en fer pré-traitée

Il n'est pas nécessaire de la culotter avant la première utilisation. Pour une cuisson saine avec peu de matière grasse.

# Flavoria

Edelstahl 18/10 · Stainless steel 18/10 · Inox 18/10



## Die Hochwertige, mit Raffinesse

Innen fein matt gebürstet, außen glänzend. Alle Töpfe sind mit einer Skala versehen. Energiesparboden durch IMPACT BONDING. Sehr hochwertig in der Verarbeitung. Induktionsgeeignet.

## High-quality with sophistication

A fine matt polished finish on the inside, with a glossy finish on the outside. All pots feature a scale. Energy-saving base, thanks to IMPACT BONDING. Extremely high-quality workmanship. Suitable for induction hobs.

## La Haut de Gamme raffinée

Une finition haut de gamme avec un intérieur mat poli et un extérieur brillant. Fond à économie d'énergie système Impact Bonding. Compatible induction.



## Kochgeschirrsreihe aus Edelstahl in Perfektion

Griffen aus Edelstahlguss und ein aufwendig gefalteter, gebördelter Rand verleihen diese Serie ein hochwertiges Auftreten. Der besondere Rand macht ein tropffreies Ausgießen möglich. Der Boden wurde mit der „Impact-Bonding“ Technologie verarbeitet. Diese sorgt für eine perfekte Bodenhaftung, einen maximalen Widerstand gegenüber Temperaturschocks und einer optimalen Wärmeverteilung. Besonders energiesparend, robust und pflegeleicht.

## Perfect stainless steel cookware range

Elaborately folded and crimped edge. The specially worked edge ensures drip-free pouring. The base has been treated with "Impact Bonding" technology for perfect adhesion of the base.

## Perfection de finition pour cette série d'ustensiles de cuisine

En acier inoxydable de haute qualité. Le bord spécial permet de verser avec facilité. La technologie "impact bonding" assure une fixation irréprochable du fond. Une vraie garantie de solidité.

NEW

Flavoria

Hochwertige Verarbeitung  
mit mancher Raffinesse







Ausgeklügeltes Ausgießsystem ohne Nachtropfen

12 cm

**Milchtopf 14 cm Ø, 1,6 L**  
Milk pot · Pot à lait

1	-	8	📦
<b>10184</b>		4025457101847	
1 Ausguss · 1 spout · 1 bec			

7 cm

**Stielkasserolle 12 cm Ø, 0,6 L**  
Casserole with handle  
Casserole à manche

1	-	8	📦
<b>10179</b>		4025457101793	
2 Ausgüsse · 2 spout · 2 becs			

Ausgeklügeltes Ausgießsystem.  
Kein Nachtropfen.

Sophisticated pouring system.  
No dripping.

Bec verseur intégré.  
Pas de débordement du liquide.

7 cm

**Stielkasserolle 14 cm Ø, 0,8 L**  
Casserole with handle  
Casserole à manche

1	-	8	📦
<b>10180</b>		4025457101809	
2 Ausgüsse · 2 spouts · 2 becs			

8 cm

**Stielkasserolle 16 cm Ø, 1,3 L**  
Casserole with handle  
Casserole à manche

1	-	6	📦
<b>10181</b>		4025457101816	
2 Ausgüsse · 2 spouts · 2 becs			

9 cm

**Stielkasserolle 18 cm Ø, 1,8 L**  
Casserole with handle  
Casserole à manche

1	-	6	📦
<b>10182</b>		4025457101823	
2 Ausgüsse · 2 spouts · 2 becs			

10 cm

**Stielkasserolle 20 cm Ø, 2,6 L**  
Casserole with handle  
Casserole à manche

1	-	4	📦
<b>10183</b>		4025457101830	
2 Ausgüsse · 2 spouts · 2 becs			



**Bratentopf 16 cm Ø, 1,2 L**  
Saucepot · Faitout

1 - 4

**10171** 4025457101717



**Bratentopf 20 cm Ø, 2,4 L**  
Saucepot · Faitout

1 - 4

**10172** 4025457101724



**Bratentopf 24 cm Ø, 4,6 L**  
Saucepot · Faitout

1 - 4

**10173** 4025457101731



**Fleischtopf 16 cm Ø, 1,6 L**  
Covered saucepot · Faitout

1 - 4

**10174** 4025457101748



**Fleischtopf 20 cm Ø, 3,2 L**  
Covered saucepot · Faitout

1 - 4

**10175** 4025457101755



**Fleischtopf 24 cm Ø, 5,5 L**  
Covered saucepot · Faitout

1 - 4

**10176** 4025457101762



**Gemüsetopf 24 cm Ø, 8 L**  
Stock pot · Marmite

1 - 4

**10177** 4025457101779



**Gemüsetopf 28 cm Ø, 12,2 L**  
Stock pot · Marmite

1 - 2

**10178** 4025457101786

# Flavoria

Für mehr Vitamine  
und Geschmack.  
Einsatz auch  
als Sieb verwendbar.

Der Dünster eignet sich bestens  
zum Dämpfen von Kartoffeln  
und Gemüse.

The steamer is ideal for stewing  
potatoes or vegetables.

Le cuisneur vapeur est particulièrement  
adapté pour la cuisson de  
légumes et pommes de terre.



**Dünsteinsatz 20 cm Ø**  
Bio-steamer · Cuit vapeur  
1 - 6   
**10192** 4025457101922



**Universal-Dünster 20 cm Ø, 2,4 L**  
Bio-steamer · Cuit vapeur  
1 - 4   
**10190** 4025457101908  
Mit Einsatz · With insert · Avec panier



**Universal-Dünster 20 cm Ø, 2,4 L**  
Bio-steamer · Cuit vapeur  
1 - 4   
**10191** 4025457101915  
Mit 2 Einsätzen  
With 2 insert · Avec 2 paniers



**Schmorpfanne 24 cm Ø**  
Stewing pan · Sauteuse  
1 - 6   
**10185** 4025457101854



**Servierpfanne 28 cm Ø**  
Serving pan · Sauteuse  
1 - 6   
**10186** 4025457101861



**Bratpfanne 20 cm Ø**  
Frying pan · Poêle  
1 - 6   
**10187** 4025457101878



**Bratpfanne 24 cm Ø**  
Frying pan · Poêle  
1 - 6   
**10188** 4025457101885



**Bratpfanne 28 cm Ø**  
Frying pan · Poêle  
1 - 6   
**10189** 4025457101892





**Stielkasserollen-Set 3-tlg.**

Casserole with long handle  
Série de 3 casseroles

1 - 2

**10200** 4025457102004

16 cm Ø, 18 cm Ø, 20 cm Ø

Alle mit 2 Ausgüssen  
2 spouts · 2 becs



**16 cm Ø, 24 cm Ø**

Fleischtopf · Covered saucepot · Faitout

**20 cm Ø**

Bratentopf · Saucepot · Faitout

**16 cm Ø**

Stielkasserolle mit 2 Ausgüssen  
Casserole with long handle 2 spout  
Casserole à manche 2 becs

**Kochtopf-Set Flavoria 4-tlg.**

Cooking pot set · Batterie de cuisine

1 - 2

**10201** 4025457102011



# Cailin

Edelstahl 18/10 · Stainless steel 18/10 · Inox 18/10

Unverwüstliche Kochtopfserie für die Grundausstattung  
Einstiegspreislagel. Induktionsgeeignet.

Indestructible saucepan range for your first basic equipment  
Entry-level price. Suitable for induction hobs.

Série d'ustensiles de cuisine de qualité tout  
en brillance et au design contemporain.  
Excellent rapport qualité prix. Compatible induction.



**Deckelknopf aus Edelstahl**

Stainless steel knob  
Anse en inox

**Schüttrand**

Pouring rim  
Rebord verseur

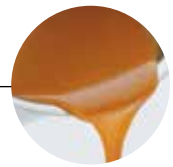

0-220°

**Glasdeckel**

Glass lid  
Couvercle en verre

0-180°

**Allherdboden**

Universal base  
Fond tous feux



**Edelstahl**

Edelstahltopfe sind die am meisten verkauften  
Töpfe in Deutschland. Sie sind extrem robust,  
langlebig und pflegeleicht.  
Durch den Kapselboden sind unsere Töpfe für  
alle Herdarten nutzbar.  
Zeitlos schlicht und preislich unschlagbar –  
das ist Cailin.

**Stainless steel**

Stainless steel saucepans are the best-selling  
saucepans in Germany. They are extremely ro-  
bust, durable and easy-care. Their capsule base  
makes our saucepans suitable for use on  
all kinds of cookers. Timelessly simple and  
value for money – that's Cailin.

**Une collection à succès**

Extrêmement robuste, durable et facile à  
nettoyer. Parfaitement adaptée à toutes les  
surfaces de cuisson. Une gamme intemporelle  
et un excellent rapport qualité/prix - c'est Cailin!

Cailin

Preis-Leistung  
unschlagbar





# Cailin



**10963 / 10964**  
**mit Innenskalierung**  
 with interior scaling  
 avec échelle de mesure intérieure



**Milchtopf 14 cm Ø, 1,8 L**  
 Milk pot · Pot à lait  
 1 - 12

**10963** 4025457109638



**Stielkasserolle 16 cm Ø, 1,5 L**  
 Casserole with handle  
 Casserole à manche  
 1 - 6

**10964** 4025457109645



**Bratentopf 16 cm Ø, 1,5 L**  
 Saucepot · Faitout  
 1 - 6

**10955** 4025457109553



**Bratentopf 20 cm Ø, 3,0 L**  
 Saucepot · Faitout  
 1 - 4

**10956** 4025457109560



**Bratentopf 24 cm Ø, 5,0 L**  
 Saucepot · Faitout  
 1 - 4

**10957** 4025457109577



**Gemüsetopf 24 cm Ø, 9,0 L**  
 Stock pot · Marmite  
 1 - 2

**10961** 4025457109614



**Fleischtopf 16 cm Ø, 1,7 L**  
 Covered saucepot · Faitout  
 1 - 6

**10958** 4025457109584



**Fleischtopf 20 cm Ø, 3,5 L**  
 Covered saucepot · Faitout  
 1 - 4

**10959** 4025457109591



**Fleischtopf 24 cm Ø, 6,0 L**  
 Covered saucepot · Faitout  
 1 - 4

**10960** 4025457109607



**Gemüsetopf 28 cm Ø, 13,5 L**  
 Stock pot · Marmite  
 1 - 2

**10962** 4025457109621



**Bratpfanne 24 cm Ø**  
 Frying pan · Poêle  
 1 - 6

**11674** 4025457116742



**Bratpfanne 28 cm Ø**  
 Frying pan · Poêle  
 1 - 6

**11675** 4025457116759



**Greblon® Antihafbeschichtung**  
 Greblon® non-stick coating  
 Revêtement anti adhérent Greblon®



**Bratpfanne 20 cm Ø**  
 Frying pan · Poêle  
 1 - 6

**11670** 4025457116704



**Bratpfanne 24 cm Ø**  
 Frying pan · Poêle  
 1 - 6

**10965** 4025457109652



**Bratpfanne 28 cm Ø**  
 Frying pan · Poêle  
 1 - 6

**10966** 4025457109669

Für mehr Vitamine  
und Geschmack  
Einsatz auch  
als Sieb verwendbar



Der Dünster eignet sich bestens zum Dämpfen von Kartoffeln und Gemüse.

The steamer is ideal for stewing potatoes or vegetables.  
Le cuiseur vapeur est particulièrement adapté pour la cuisson de légumes et pommes de terre.

Universal-Dünster 20 cm Ø, 2,4 L  
Bio-steamer · Cuit Vapeur

1 - 4

10994 4025457109942



Pastatopf, mit Pasta-Siebeinsatz, zur einfachen Handhabung.

With pasta strainer insert – for easy handling.  
Avec passoire à pâtes – pour une utilisation simple.

Pastatopf Cailin 24 cm Ø, 5,8 L  
Pasta pot · Cuit pâtes

1 - 4

10991 4025457109911



Fondue-Set  
Fondue-set · Service à fondue

1 - 4

10968 4025457109683

10-teilig · 10 pieces · 10 pièces

a 18/10 Edelstahl · Stainless steel · Inox  
b Edelstahl · Stainless steel · Inox



16 cm Ø, 24 cm Ø  
Fleischtopf · Covered saucepot · Faitout  
20 cm Ø Bratentopf · Saucepot · Faitout  
16 cm Ø Stielkasserolle · Casserole with long handle · Casserole à manche



Kochtopf-Set Cailin 4-tlg.  
Cooking pot set · Batterie de cuisine

1 - 2

10969 4025457109690

**Dampfgarer**

Hochwertiges Edelstahl. Handliche, große Griffe. Nach Herausnahme des Dämpfeinsatzes auch als Bräter verwendbar. Einfache Reinigung in der Spülmaschine.

**Steam cookers**

High-grade stainless steel. Practical large handles. Ideal as a roasting pan after removal of the steam insert. Simple to clean in the dishwasher.

**Cuiseur Vapeur multi-fonctions**

Acier inoxydable de haute qualité. Maniable, grandes poignées. Peut également être utilisé comme plat à four après avoir retiré l'élément vapeur. Facile à nettoyer au lave-vaisselle.



Schonende, geschmacksintensive Zubereitung

**Allherdboden**

Universal base  
Fond tous feux

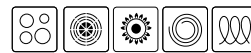

15,5 cm



0-180°



0-300°

**Dampfgarer 44 x 27 cm 5,8 L**

Steam cookers · Cuit vapeur

1 - 3 

12400 4025457124006

Mit Einsatz · With insert · Avec insert

Deckel: Glas · Lid: glass · Couvercle: verre



# Frutta



Edelstahl 18/10 · Stainless steel 18/10 · Inox 18/10

Geschmacks- und geruchsneutral, lebensmittelecht, säurefest und spülmaschinengeeignet (Ausnahme: Silikonschlauch). Der Kapselboden sorgt für eine gleichmäßige Wärmeverteilung und -speicherung.

No taste or odour, is food-safe, acid-resistant and dishwasher-safe (exception: silicone hose). The capsule floor ensures an even heat distribution and storage.

Parfaitement neutre aux goûts et aux odeurs, constitué d'un matériau adapté au contact alimentaire, résistant aux acides alimentaires et adapté au lave-vaisselle (à l'exception du tuyau en silicone). Le fond en capsulé garantit une répartition et un stockage homogène de la chaleur.

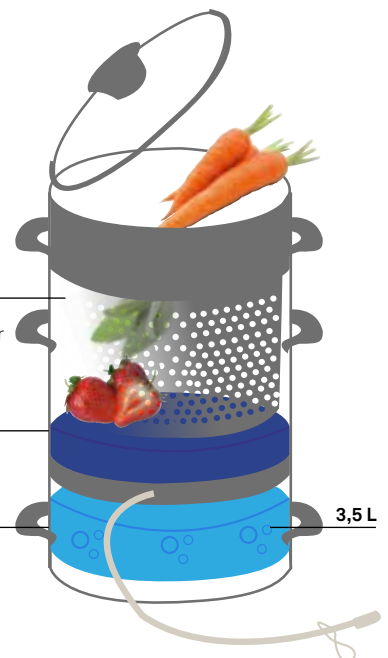

**Fruchtkorb**  
Collection vessel  
Récipient récupérateur

**Pasteurisierte Saft**  
Pasteurised juice  
Jus pasteurisé

**Kochendes Wasser**  
Boiling water  
Eau bouillante

3,5 L

Dampfensafter 25 cm Ø  
Steam juicer  
Extracteur de jus à vapeur

1 - 4

10992 4025457109928

# Asia / Mini

Gusseisen · Cast iron · Fonte

## Klassischer Wok aus Gusseisen

Die Woks aus Gusseisen sind mit einer rauen Emaillie-Beschichtung versehen. Zur Auswahl stehen zwei Größen. Perfekt geeignet für die Zubereitung von Speisen auf dem Grill.

## Traditional cast-iron wok

These cast-iron woks feature a rough enamel coating. There are two sizes available. Perfect for preparing dishes on the barbecue.

## Wok classique en fonte

Il existe deux tailles au choix. Parfait également pour préparer les aliments sur le grill.



### Wok-Set Asia 36 cm Ø, 4,5 L

Wok set · Set Wok

1 - 2

**77943** 4025457779435

5-teilig · 5 pieces · 5 pièces

a Gusseisen · Cast iron · Fonte de fer  
b Metall · Metal · Métal  
c Edelstahl · Stainless steel · Inox  
d Bambus · Bamboo · Bambou



### Wok-Set Mini 24 cm Ø, 1,6 L

Wok set · Set Wok

1 - 3

**77747** 402545777479

5-teilig · 5 pieces · 5 pièces

a Gusseisen · Cast iron · Fonte de fer  
b Glas · Glass · Verre  
c Edelstahl · Stainless steel · Inox  
d Bambus · Bamboo · Bambou

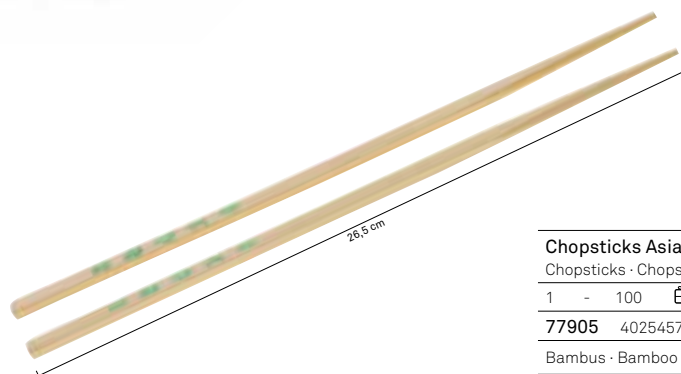

10x

### Chopsticks Asia

Chopsticks · Chopsticks

1 - 100

**77905** 4025457779053

Bambus · Bamboo · Bambou

10 Paar · 10 Pairs · 10 Paires

Edelstahl 18/10 · Stainless steel 18/10 · Inox 18/10

**Stylischer Wasserkessel mit großem Allherdboden**  
 Dank des verstärkten Körpers und einem perfekt schließenden Fülldeckel wird das Wasser schnell und energiesparend zum Kochen gebracht. Der Griff verfügt über eine integrierte Taste zum sicheren Öffnen des Ausgussdeckels. Sobald das Wasser kocht, ertönt ein Pfeifton. Hochwertige Verarbeitung. Für alle Herdarten geeignet, auch Induktion.

**Stylish and robust**  
 Its large base makes the whistling kettle perfect for boiling water quickly and in an energy-saving manner. And should you happen to forget the kettle on the cooker, it is guaranteed to remind you by whistling.

**Chic et robuste**  
 Grâce à sa grande empreinte, la bouilloire à bec est très adaptée pour porter l'eau à ébullition rapidement et en économisant l'énergie. Son sifflet se fait entendre dès que l'eau est à température idéale. High quality. Finition haut de gamme. Pour tous feux, y compris induction.



**Klappmechanismus im Griff**  
 Hinge mechanism in the handle  
 Gâchette d'ouverture intégrée



**Pfeift, sobald das Wasser kocht**  
 Whistles when the water is boiling  
 Bouchon siffleur

**Allherdboden**  
 Universal base  
 Fond tous feux



**Wasserkessel 3,0 L**  
 Kettle · Bouilloire  
 1 - 12   
**11655** 4025457116551  
 Silber · Silver · Argent



**Weiß · White · Blanc**  
**11657** 4025457116575



**Rot · Red · Rouge**  
**11658** 4025457116582



**Schwarz · Black · Noir**  
**11656** 4025457116568



# Maila

Keramik · Matt  
 Ceramic · Matt  
 Céramique · Mat



Die saubere Alternative zum Ofenhandschuh



**Servier- und Auflaufform**  
 Casserole dish · Plat à four  
 1 2 8

12482 4025457124822



**Servier- und Auflaufform**  
 Casserole dish · Plat à four  
 1 2 8

12483 4025457124839

**Ofenzange Maria**  
 Oven tongs · Pince à four  
 1 6 60

10826 4025457108266

18/10 Edelstahl · Stainless steel · Inox

Silikon · Silicone · Silicone

# Ester

Porzellan weiß · Glänzend  
 Porcelain white · Bright  
 Porcelaine blanche · Brillant

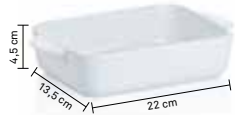

**Servier- und Auflaufform**  
 Casserole dish · Plat à four  
 1 3 12

11685 4025457116858

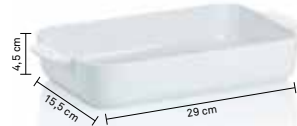

**Servier- und Auflaufform**  
 Casserole dish · Plat à four  
 1 2 8

11686 4025457116865



**Servier- und Auflaufform**  
 Casserole dish · Plat à four  
 1 2 8

11687 4025457116872



**Servier- und Auflaufform**  
 Casserole dish · Plat à four  
 1 2 6

11688 4025457116889

# Maleen

Porzellan weiß · Glänzend  
 Porcelain white · Bright  
 Porcelaine blanche · Brillant

**SET** CE issued by  
 DVGW, Germany  
 DIN EN ISO 9994



**Schälchen Maleen**  
 Crème brûlée dish  
 Ramequin crème brûlée  
 6\* 48

10763 4025457107634



**Schälchen Maleen**  
 Crème brûlée dish  
 Coupelles crème brûlée  
 - 6\* 48

10759 4025457107597



**Gourmet-Gasbrenner Manou**  
 Gourmet gas burner · Gourmet brûleur gaz  
 1 - 20

10947 4025457109478

Metall · Metal · Métal

Silber · Silver · Argent



**Crème Brûlée-Set Manou**  
 Crème brûlée set · Set de crème brûlée  
 1 - 8

10948 4025457109485

5-teilig · 5 pieces · 5 pièces

4x Schälchen, 1x Gasbrenner  
 4x Dishes, 1x Gas burner  
 4x Coupelles, 1x Gourmet brûleur gaz

# Malin

Keramik · Glänzend  
Ceramic · Bright  
Céramique · Brillant

0-280°



Servier- und Auflaufform  
Casserole dish · Mini Cocotte

- 3\* 24

**11865** 4025457118654

Rot/Beige · Red/Beige · Rouge/Beige



Servier- und Auflaufform  
Casserole dish · Plat à four

- 4\* 12

**11860** 4025457118609

Rot/Beige · Red/Beige · Rouge/Beige



Servier- und Auflaufform  
Casserole dish · Plat à four

- 3\* 6

**11862** 4025457118623

Rot/Beige · Red/Beige · Rouge/Beige



Servier- und Auflaufform  
Casserole dish · Plat à four

- 3\* 6

**11863** 4025457118630

Rot/Beige · Red/Beige · Rouge/Beige

**NEW**



Servier- und Auflaufform  
Casserole dish · Mini Cocotte

- 3\* 24

**11937** 4025457119378

Schwarz/Beige · Black/Beige · Noir/Beige

**NEW**



Servier- und Auflaufform  
Casserole dish · Plat à four

- 4\* 12

**11934** 4025457119347

Schwarz/Beige · Black/Beige · Noir/Beige

**NEW**



Servier- und Auflaufform  
Casserole dish · Plat à four

- 3\* 6

**11935** 4025457119354

Schwarz/Beige · Black/Beige · Noir/Beige

**NEW**



Servier- und Auflaufform  
Casserole dish · Plat à four

- 3\* 6

**11936** 4025457119361

Schwarz/Beige · Black/Beige · Noir/Beige

# Concetta

Glas · Silikonrand · Schwarz  
 Glass · Silicone rim · Black  
 Verre · Rebord silicone · Noir

0-180°



<b>Glasdeckel</b>	
Glass lid · Couvercle en verre	
1	6 12
<b>11440</b>	4025457114403
Schwarz · Black · Noir	
Passend für · Suitable for · Convient pour 16/18/20 cm Ø	



<b>Glasdeckel</b>	
Glass lid · Couvercle en verre	
1	6 12
<b>11441</b>	4025457114410
Schwarz · Black · Noir	
Passend für · Suitable for · Convient pour 22/24/26 cm Ø	



<b>Glasdeckel</b>	
Glass lid · Couvercle en verre	
1	6 12
<b>11442</b>	4025457114427
Schwarz · Black · Noir	
Passend für · Suitable for · Convient pour 28/30/32 cm Ø	



Der Universaldeckel passt sich Töpfen und Pfannen über drei Größen an. Mit Silikonrand und Dampfauslassventil.

The all-purpose lid fits three sizes of pots and pans. With silicone rim and steam vent.

Le couvercle universel s'adapte à toutes les poêles et casseroles sur 3 dimensions. Avec rebord en silicone et évacuateur de vapeur.

# Callisto

Glas · Edelstahlrand · Bakelitknopf schwarz  
 Glass · Stainless steel rim · Bakelite knob black  
 Verre · Rebord en acier · Bouton bakélite noir

0-180°



<b>Glasdeckel 16 cm Ø</b>	
Glass lid · Couvercle en verre	
1	- 16
<b>10870</b>	4025457108709



<b>Glasdeckel 20 cm Ø</b>	
Glass lid · Couvercle en verre	
1	- 16
<b>10871</b>	4025457108716



<b>Glasdeckel 24 cm Ø</b>	
Glass lid · Couvercle en verre	
1	- 8
<b>10872</b>	4025457108723



<b>Glasdeckel 28 cm Ø</b>	
Glass lid · Couvercle en verre	
1	- 8
<b>10873</b>	4025457108730



<b>Pfannen-Glasdeckel 24 cm Ø</b>	
Glass lid · Couvercle en verre	
1	- 8
<b>10995</b>	4025457109959



<b>Pfannen-Glasdeckel 28 cm Ø</b>	
Glass lid · Couvercle en verre	
1	- 10
<b>10996</b>	4025457109966



# Elvira / Cosima

Edelstahl 18/10  
Stainless steel 18/10  
Inox 18/10



**Spritzschutz Elvira**  
Splash guard · Grille anti-éclaboussures

1 - 24

**11476** 4025457114762

Passend für: Suitable for: · Convient pour: 20/24/28 cm Ø

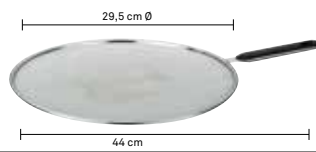

**Spritzschutz Cosima**  
Splash guard · Grille anti-éclaboussures

1 24 72

**17116** 4025457171161



**31/35/39 cm Ø** **3x**

**Pfannenschutz-Set Amparo**  
Pan protection set · Set protection poêle

- 12\* 24

3-teilig · 3 pieces · 3 pièces



**12327** 4025457123276

1x Dunkelgrau · Sommerblau · Hellgrau  
1x Dark grey · Summer blue · Light grey  
1x Gris foncé · Été blue · Gris clair



**12328** 4025457123283

1x Dunkelgrau · Minzgrün · Hellgrau  
1x Dark grey · Mint green · Light grey  
1x Gris foncé · Vert menthe · Gris clair

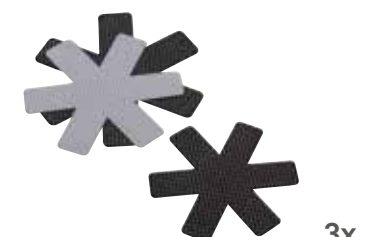

**11652** 4025457116520

2x Schwarz · 1x Grau  
2x Black · 1x Grey · 2x Noir · 1x Gris

## Amparo

Filtz 3 mm  
Felt 3 mm  
Feutre 3 mm

# Flex

Frischhaltedeckel · Silikon  
 Freshness lid · Silicone  
 Couvercle fraîcheur · Silicone

-40-230°

Optimales Aufbewahren  
 dank stapelbarem Deckelsystem.

Optimum storage, thanks  
 to stacking lid system.

Rangement pratique  
 par empilage.



2x

Frischhaltedeckel 10 cm Ø  
 Freshness lid · Couvercle fraîcheur

1 12 48

10053 4025457100536

Minzgrün · Mint green · Vert menthe



Frischhaltedeckel 20 cm Ø  
 Freshness lid · Couvercle fraîcheur

1 12 48

10052 4025457100529

Minzgrün · Mint green · Vert menthe



Frischhaltedeckel 26 cm Ø  
 Freshness lid · Couvercle fraîcheur

1 12 36

10051 4025457100512

Minzgrün · Mint green · Vert menthe



Frischhaltedeckel 30 cm Ø  
 Freshness lid · Couvercle fraîcheur

1 12 36

10050 4025457100505

Minzgrün · Mint green · Vert menthe

Vor- und Zubereiten · Preparation and preparation · Préparation et préparation

# TEAMWORK





# Rondo

## Edelstahl

Stainless steel

Inox

Die Serie Rondo überzeugt durch ihre hochwertige Verarbeitung seit mehr als 25 Jahren. Langlebigkeit und ein starkes zeitloses Design – das ist kela.

The Rondo series convinces with its high-quality and its timeless form for more than 25 years. Thus, it stands for quality, design and the sustainability of the Kela brand.

La Gamme Rondo, en collection chez Kela depuis plus de 25 ans est reconnue pour sa fabrication haut de gamme, sa ligne intemporelle et sa longue durée de vie. Elle est exemple de la qualité, du design et du suivi produit de la marque kela.



**Pfannenwender**  
Slotted spatula · Spatule ajourée

1 12 72

19003 4025457190032



**Schaumlöffel**  
Skimmer · Ecuimoir

1 12 72

19005 4025457190056



**Kartoffelstampfer**  
Potato masher · Ecrase pomme de terre

1 12 72

19006 4025457190063

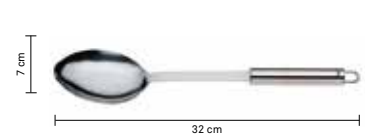

**Servierlöffel**  
Serving spoon · Cuillère à service

1 12 72

19007 4025457190070



**Saucenlöffel**  
Gravy ladle · Cuillère à sauce

1 12 72

19002 4025457190025

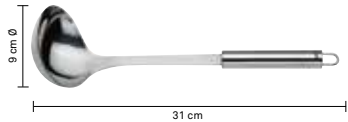

**Suppenschöpfer**  
Soup ladle · Louche

1 12 72

19001 4025457190018



**Spaghettilöffel**  
Spaghetti spoon · Cuillère à spaghetti

1 12 72

19061 4025457190612

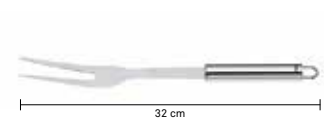

**Fleischgabel**  
Carving fork · Fourchette à viande

1 12 72

19004 4025457190049

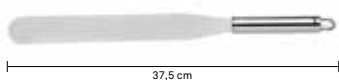

**Kuchenpalette**  
Icing spatula · Spatule plate

1 12 72

19140 4025457191404



**Winkelpalette**  
Icing spatula · Spatule coudée

1 12 72

19139 4025457191398



**Mini-Schneebeesen**  
Mini egg whisk · Fouet mini

1 24 144

19024 4025457190247



**Schneebeesen**  
Egg whisk · Fouet plat

1 10 150

19028 4025457190285



**Schneebeesen**  
Egg whisk · Fouet

1	12	144
<b>19019</b>	4025457190193	



**Schneebeesen**  
Egg whisk · Fouet

1	12	120
<b>19027</b>	4025457190278	

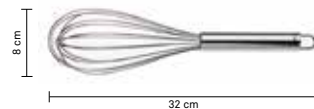

**Schneebeesen**  
Egg whisk · Fouet

1	12	96
<b>19020</b>	4025457190209	



**Pizzaschneider**  
Pizza cutter · Roulette à pizza

1	12	72
<b>19013</b>	4025457190131	

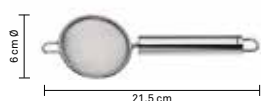

**Kaffeeseieb**  
Coffee strainer · Passoire à café

1	12	144
<b>19017</b>	4025457190179	



**Eisportionierer**  
Ice cream scoop · Cuillère à glace

1	12	96
<b>19022</b>	4025457190223	



**Eisportionierer**  
Ice cream scoop · Cuillère à glace

1	12	72
<b>19135</b>	4025457191350	



**Gewürzreibe**  
Spice grater · Râpe épices

1	12	144
<b>19010</b>	4025457190100	



**Dosenöffner**  
Can opener · Ouvre-boîte

1	12	48
<b>19000</b>	4025457190001	



**Knoblauchpresse**  
Garlic press · Presse-ail

1	12	48
<b>19062</b>	4025457190629	



Perfekte Reinigung durch Silikonkuppen auf der Rückseite  
Perfect to clean, thanks to the silicone studs on the rear.  
Un nettoyage facile grâce aux picots en silicone.

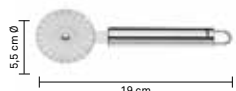

**Teigrad**  
Pastry wheel · Roulette à pâte

1	12	144
<b>19014</b>	4025457190148	



**Backpinsel**  
Baking brush · Pinceau de cuisine

1	12	144
<b>15931</b>	4025457159312	
Silikon · Silicone · Silicone		
Schwarz · Black · Noir		



**Tortenheber**  
Cake server · Pelle à tarte

1	12	144
<b>19016</b>	4025457190162	



**Zestenreißer**  
Zester · Zesteur

1	12	144
<b>19033</b>	4025457190339	



**Apfelausstecher**  
Apple corer · Vide pomme

1	12	144
<b>19012</b>	4025457190124	

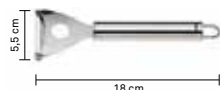

**Sparschäler Y-Form**  
Potato peeler · Rasoir à légumes forme Y

1	12	144
<b>19038</b>	4025457190384	



**Sparschäler**  
Potato peeler · Eplucheur

1	12	216
<b>19009</b>	4025457190094	



**Sparschäler**  
Potato peeler · Rasoir pomme de terre

1	12	144
<b>19039</b>	4025457190391	



**Käsemesser**  
Cheese knife · Couteau à fromage

1	12	120
<b>15326</b>	4025457153266	



**Käseschneider**  
Cheese cutter · Eminceur fromage

1	12	144
<b>19029</b>	4025457190292	

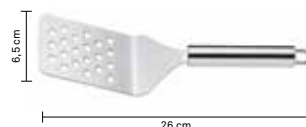

**Palette**  
Palette spatula · Spatule plate

1	12	144
<b>19032</b>	4025457190322	

NEW

## Rondo

Edelstahl  
Stainless steel  
Inox

### Reiben von höchster Qualität

Die Reiben verfügen über einen ergonomischen Spezialgriff für eine einfache Handhabung. Inklusive Schutzcover.

### High-quality graters

The graters feature an ergonomic special handle for ease of use. Includes protective cover.

### Des râpes de la plus haute qualité

Les râpes sont dotées d'un manche ergonomique spéciale pour une manipulation aisée. Housse de protection incluse.

Edelstahl 18/10  
Stainless steel - Inox

### Ergonomischer Griff

Ergonomic handle  
Manche ergonomique

Extrem scharf für  
kraftschonendes  
Reiben

### Robuster Edelstahl

Robust stainless steel  
Acier inoxydable robuste

### Edelstahl 18/10

18/10 stainless steel  
Acier inoxydable 18/10

### Speziell geätzte Reibezähne

Specially etched grater teeth  
Micro picots acérés

### TPE Auflage für rutschfestes Arbeiten

TPE coating for non-slip working  
Revêtement TPE antidérapant



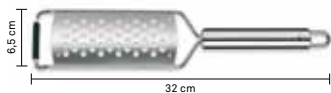

**Kronenreibe fein**  
Grater fine · Râpe

1 12 48

12576 4025457125768

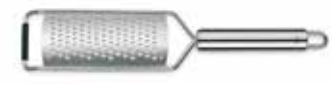

**Raspel fein**  
Grater fine · Râpe

1 12 48

12575 4025457125751



**Raspel**  
Grater · Râpe

1 12 48

12573 4025457125737



**Raspel grob**  
Grater coarse · Râpe

1 12 48

12574 4025457125744



**Zestenreibe fein**  
Zester fine · Râpe

1 12 48

12571 4025457125713



**Zestenreibe grob**  
Zester coarse · Râpe

1 12 48

12572 4025457125720



**Profi**  
Edelstahl  
Stainless steel · Inox

**4-Kant-Reibe Profi**  
4-sided grater · Râpe 4 faces

1 12 72

19065 4025457190650

Edelstahl · Stainless steel · Inox

# Livia

Buche  
Beech  
Hêtre



**Kochlöffel mit Loch**  
Kitchen spoon with hole · Cuillère à trou

1 24 96

**11784** 4025457117848



**Kochlöffel**  
Kitchen spoon · Cuillère

1 24 96

**11783** 4025457117831



**Pfannenwender**  
Spatula · Spatule

1 24 96

**11781** 4025457117817



**Pfannenwender**  
Spatula · Spatule

1 24 96

**11782** 4025457117824

# Maribor

Buche  
Beech  
Hêtre



**Honiglöffel**  
Honey spoon · Cuillère à miel

1 10 480

**23355** 4025457233555

Ahorn · Maple · Erable

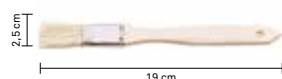

**Backpinsel**  
Baking brush · Pinceau de cuisine

1 20 400

**23344** 4025457233449

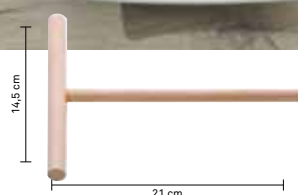

**Crêpe-Schieber**  
Crêpe-slide · Spatule crêpe

1 10 250

**23354** 4025457233548



**Gurkenzange**  
Cucumber tongs · Pince à cornichons

1 10 240

**23349** 4025457233494

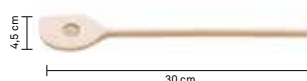

**Spitzkochlöffel mit Loch**  
Pointed hole cooking spoon  
Cuillère pointue avec trou

1 10 500

**23335** 4025457233357

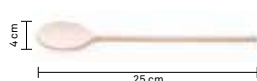

**Kochlöffel**  
Kitchen spoon · Cuillère

1 10 600

**23331** 4025457233319



**Kochlöffel**  
Kitchen spoon · Cuillère

1 10 500

**23332** 4025457233326

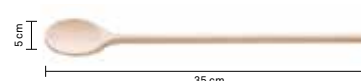

**Kochlöffel**  
Kitchen spoon · Cuillère

1 10 400

**23333** 4025457233333

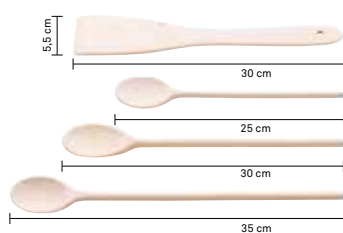

**SET**  
4X

**Kochlöffel-Set**  
Kitchen spoon set · Set cuillères

1 - 50

**17253** 4025457172533

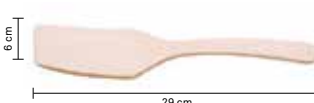

**Pfannenwender**  
Spatula · Spatule

1 10 400

**23341** 4025457233418



**Pfannenwender**  
Spatula · Spatule

1 10 450

**23338** 4025457233388

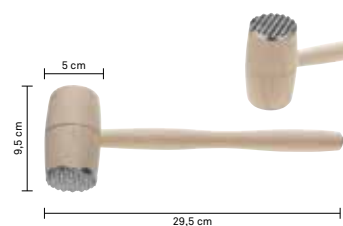

**Fleischklopper Maribor**  
Meat tenderiser · Attendrisseur

1 - 12

**17302** 4025457173028

Buche · Beech · Hêtre

Metallaufsatz auf einer Seite  
Metallic charge on one side  
Insert métallique sur un côté



**Teigroller**  
Rolling pin · Rouleau à pâtisserie

1 - 12

**23347** 4025457233470

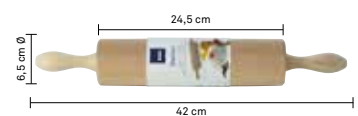

**Teigroller mit Kugellager**  
Rolling pin with ball bearing  
Rouleau à pâtisserie à roulement à billes

1 - 12

**17300** 4025457173004

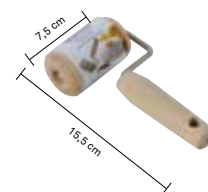

**Backblechroller**  
Pastry roller · Rouleau à pâte

1 - 12

**17304** 4025457173042



# Tom

Silikon · Grau  
Silicone · Grey  
Silicone · Gris

-40-250°

Der stabile und gleichzeitig flexible Silikonwender hat abgeschrägte Kanten. Dadurch lässt sich das Bratgut perfekt anheben. Für alle Kochgeschirrarten geeignet – ideal bei beschichtetem Kochgeschirr. Hitzebeständig bis 250°C und spülmaschinen geeignet.

The bevelled edges of the slotted turners ensure that fried food can be lifted easily. The material is suitable for all kinds of cookware. Extra-gentle on coated materials. Heat-resistant to 230 °C and dishwasher-safe.

Les bords biseautés de la spatule permettent de soulever les aliments de façon optimale. Le matériau en silicone convient à tous les types d'ustensiles de cuisine. Particulièrement doux pour les surfaces revêtues. Résistant jusqu'à 250° et lavable en machine.



### Abgeflachte Kanten

Flattened edges  
Bords biseautés

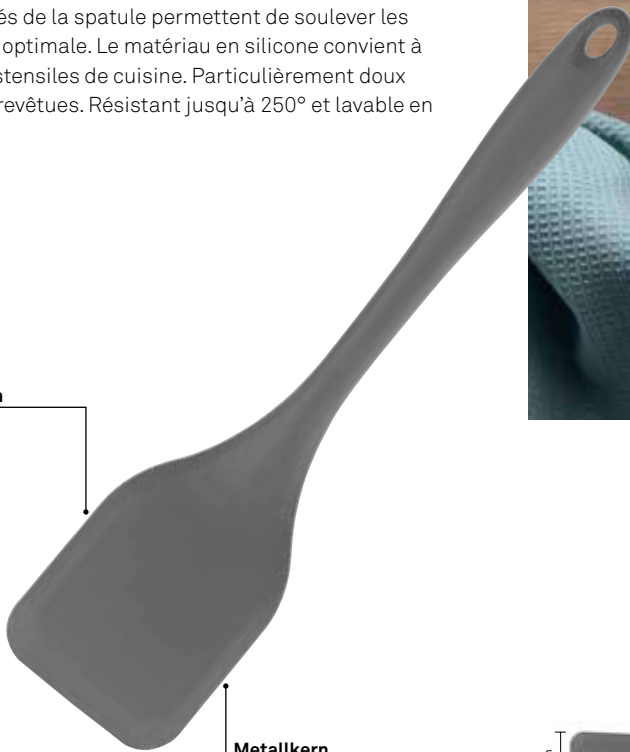

### Metallkern

Metal core  
Noyau métallique

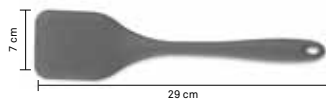

**Pfannenwender**  
Spatula · Spatule

1 12 96

12580 4025457125805

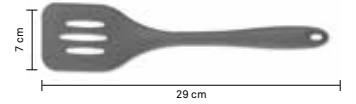

**Pfannenwender**  
Slotted spatula · Spatule ajourée

1 12 96

12581 4025457125812

NEW



**Suppenschöpfer**  
Soup ladle · Louche

1 12 72

12582 4025457125829

NEW



**Servierlöffel geschlossen**  
Serving spoon closed  
Cuillère à Service fermé

1 12 96

12583 4025457125836

NEW



**Servierlöffel geschlitzt**  
Serving spoon slotted  
Cuillère à Service ajourée

1 12 96

12584 4025457125843

NEW



**Spaghettilöffel**  
Spaghetti spoon  
Cuillère à spaghetti

1 12 96

12585 4025457125850

# Susa / Cookie

Edelstahl 18/10 · Silikon  
Stainless steel 18/10 · Silicone  
Inox 18/10 · Silicône

-40-230°



Flaschenbürste  
mit Edelstahlkern

Minzgrün · Mint green · Vert menthe

Lichtgrau · Light grey · Gris clair

Minzgrün · Mint green · Menthe vert

Lichtgrau · Light grey · Gris clair

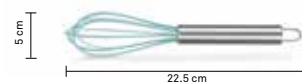
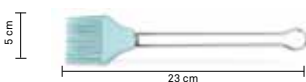

**Backpinsel Cookie**  
Baking brush · Pinceau de cuisine

1 12 96

10061 4025457100611

**Backpinsel Cookie**  
Baking brush · Pinceau de cuisine

1 12 96

10062 4025457100628

**Schneebeesen Cookie**  
Egg whisk · Fouet

1 12 96

10076 4025457100765

**Schneebeesen Cookie**  
Egg whisk · Fouet

1 12 96

10077 4025457100772

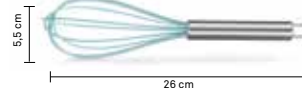

**Teigschaber Cookie**  
Dough scraper · Spatule

1 12 96

10066 4025457100666

**Teigschaber Cookie**  
Dough scraper · Spatule

1 12 96

10067 4025457100673

**Schneebeesen Cookie**  
Egg whisk · Fouet

1 12 96

10081 4025457100819

**Schneebeesen Cookie**  
Egg whisk · Fouet

1 12 96

10082 4025457100826

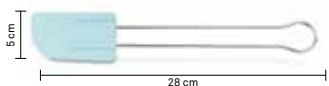

**Teigschaber Cookie**  
Dough scraper · Spatule

1 12 96

10071 4025457100710

**Teigschaber Cookie**  
Dough scraper · Spatule

1 12 96

10072 4025457100727

**Flaschenbürste Susa**  
Bottle brush · Goupillon

1 12 96

10056 4025457100567

With stainless steel core  
Avec noyau en acier inoxydable

**Flaschenbürste Susa**  
Bottle brush · Goupillon

1 12 96

10057 4025457100574

With stainless steel core  
Avec noyau en acier inoxydable

## Deli

PP-Kunststoff  
PP plastic  
PP-plastique

MADE  
IN  
GERMANY



Ein Schließmechanismus, der garantiert geschlossen bleibt.

A closing mechanism guaranteed to remain closed.

Mécanisme de fermeture sûr.



**Tortencontainer**  
Casserole dish  
Boîte de transport à Gateau  
- - 4\*  
**12173** 4025457121739  
Graphitgrau · Graphite grey · Gris graphite  
L38/ B33 / H17 cm



**Tortencontainer**  
Casserole dish  
Boîte de transport à Gateau  
- - 4\*  
**12170** 4025457121708  
Minzgrün · Mint green · Vert menthe  
L38/ B33 / H17 cm



**Obstkuchenbehälter**  
Fruitcake container  
Boîte de transport à tartes  
- - 6\*  
**12174** 4025457121746  
Graphitgrau · Graphite grey · Gris graphite  
Ø32 / H10 cm



**Party-Butler**  
Party butler  
Boîte de transport à Brownie  
- - 6\*  
**12172** 4025457121722  
Graphitgrau · Graphite grey · Gris graphite  
L45 / B30 / H9 cm



**Königskuchenbehälter**  
King's cake container  
Boîte de transport à cake  
- - 6\*  
**12175** 4025457121753  
Graphitgrau · Graphite grey · Gris graphite  
L40 / B17 / H14,5 cm

## Decore

Edelstahl 18/10  
Stainless steel 18/10  
Inox 18/10



**Dessertringe**  
Dessert rings · Emporte-pièces  
1 6 24   
**10785** 4025457107856  
3 Stück · 3 pieces · 3 pièces



**Dessertringe**  
Dessert rings · Emporte-pièces  
1 6 60   
**10780** 4025457107801  
3-teilig · 3 pieces · 3 pièces



**Dessertringe**  
Dessert rings · Emporte-pièces  
1 6 24   
**10781** 4025457107818  
3-teilig · 3 pieces · 3 pièces





# Pinta

Inklusive Batterien CR2032 1,5 V  
 Batteries included CR2032 1,5 V  
 Piles fournies CR2032 1,5 V



**3 mm Sicherheitsglas**  
 3 mm Safety glass  
 3 mm Verre de sécurité

0-5 kg

**1 g Feinteilung**  
 1 g Fine gauge  
 1 g Précision

**LCD-Display**  
 LCD-Display  
 Ecran LCD

**Tara-Funktion**  
 Tare function  
 Fonction tare



**Digital-Küchenwaage Pinta**  
 Digital kitchen scales · Balance digitale  
 1 - 20   
**15741** 4025457157417  
 Schwarz · Black · Noir



**Digital-Küchenwaage Pinta**  
 Digital kitchen scales · Balance digitale  
 1 - 20   
**15727** 4025457157271  
 Opalgrau · Opal grey · Gris opal



**Digital-Küchenwaage Pinta**  
 Digital kitchen scales · Balance digitale  
 1 - 20   
**15740** 4025457157400  
 Weiß · White · Blanc



**Digital-Küchenwaage Pinta**  
 Digital kitchen scales · Balance digitale  
 1 - 20   
**15729** 4025457157295  
 Minzgrün · Mint green · Vert menthe

Unser Einhand-Mehlsieb aus Edelstahl verfügt über ein feinmaschiges Sieb – für besonders feines Mehl und fluffige Backergebnisse.

Our one-handed stainless steel flour shaker features a fine-mesh sieve – for exceptionally fine flour and light and fluffy baking results

Notre tamis à farine en inox permet un tamisage très fin pour un excellent résultat pâtissier.



**Mehlsieb**  
 Flour sifter · Tamis  
 1 6 60  
**19045** 4025457190452

# Solido

Zinkdruckguss verchromt

Zinc die-cast chromed

Zinc moulé sous pression chromé



**Pizzaschneider Solido**  
Pizza cutter · Roulette à pizza

- 12\* 48

**10031** 4025457054068

Display L 38 cm / T16 / H24,5

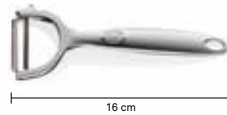

**Sparschäler Solido**  
Potato peeler · Eplucheur

- 12\* 48

**10032** 4025457054075

Display L 28 cm / T11,5 / H24,5



**Knoblauchpresse Solido**  
Garlic press · Presse-ail

- 12\* 24

**10036** 4025457054112

Display L 29,5 cm / T11,5 / H24

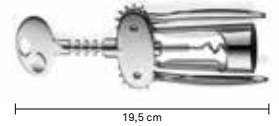

**Flügelkorkenzieher Solido**  
Wing corkscrew · Tire-bouchon à levier

- 12\* 24

**10037** 4025457054129

Display L36 / T18 / H28



**Eislöffel Solido**  
Ice cream scoop · Cuillère à glace

- 12\* 48

**10035** 4025457054105

Display L21,5 / T11,5 / H23,5 cm



**Dosenöffner Solido**  
Can opener · Ouvre-boîte

- 12\* 24

**10038** 4025457054136

Display L31 / T18 / H26,5

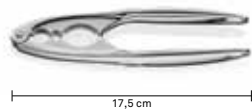

**Nussknacker Solido**  
Nutcracker · Casse noix

- 12\* 24

**10033** 4025457054082

Display L 32 / T14 / H24,5



**Nussknacker Pino**  
Nutcracker display · Display casse noix

- 12\* 48

**11468** 4025457047381

Gummierte Griffe · Rubberised handles ·  
Poignées caoutchoutées

Schwarz · Black · Noir

Display L 19 / T11 / H17

# Küchenhelfer

Selbstgemacht schmeckt doch einfach am Besten  
Home-made simply tastes best  
Fait maison



**19087** Für kurze Spätzle  
For short spaetzle  
Pour des Spaetzle courts



**19088** Für lange Spätzle  
For long spaetzle  
Pour des Spaetzle longs



**Spätzleshobel Emma**  
Spaetzle maker · Mandoline à spaetzle

1 - 12 **19087** 4025457190872



**Spätzleshobel Emma**  
Spaetzle maker · Mandoline à spaetzle

1 - 12 **19088** 4025457190889



**Kartoffelpresse Hilde**  
Potato ricer · Presse-purée

1 - 12 **11217** 4025457112171



**Spaghetti- und Spätzleszange Fresh**  
Spaghetti tongs · Pince spaghetti

1 12 72 **19123** 4025457191237

Als Flaschenöffner  
verwendbar



**Nussknacker Aki**  
Nutcracker · Casse noix

1 12 24 **10030** 4025457100307

Zinkdruckguss verchromt  
Zinc die-cast chromed  
Zinc moulé sous pression chromé

Can also be used as a bottle opener  
Utilisable également comme ouvre-bouteilles



# Schneiden

Extrem scharf und unverzichtbar in jeder Küche  
 Extremely sharp and indispensable in any kitchen  
 Extrêmement affûté – Indispensable dans chaque cuisine

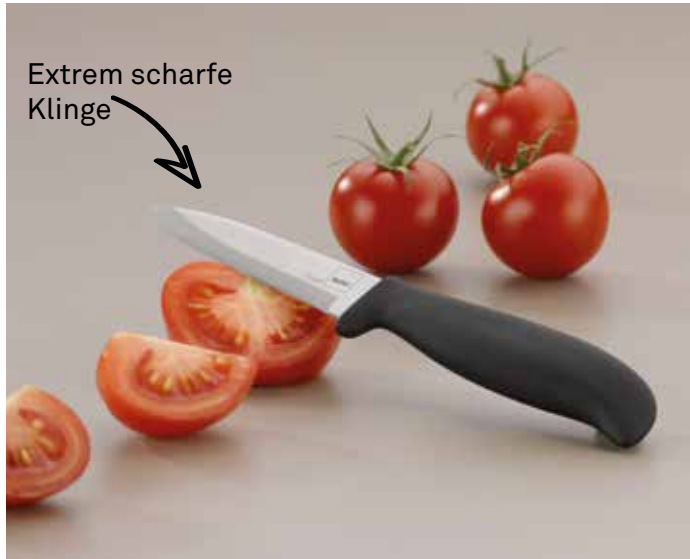

**Display Vespermesser Rapido**

Display kitchen knife  
 Display Couteaux

- 30\* 120

**11349** 4025457055928

Messerstahl | PP-Kunststoff  
 Knife steel | PP plastic  
 Lame acier | Plastique PS

Display L26 cm / T23,5 / H26



**Display Küchenmesser Skarp**

Display kitchen knife  
 Display couteaux d'office

1 30\* 120

**11348** 4025457044762

Messerstahl | PP-Kunststoff  
 Knife steel | PP plastic  
 Lame acier | Plastique PS

Display L26 cm / T22,5 / H26

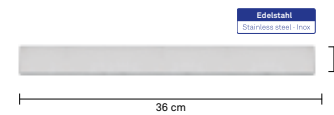

**Magnetleiste Plan**

Magnetic knife rack  
 Barre aimantée

1 6 12

**15715** 4025457157158

Edelstahl · Stainless steel · Inox

Matt · Matt · Mat

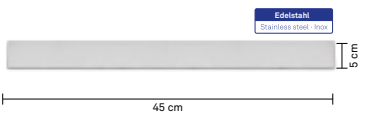

**Magnetleiste Plan**

Magnetic knife rack  
 Barre aimantée

1 5 10

**15716** 4025457157165

Edelstahl · Stainless steel · Inox

Matt · Matt · Mat



**Wiegemesser Ganda**

Chopping knife · Hachoir

1 - 50

**10866** 4025457108662

Edelstahl · Stainless steel · Inox

Griff PP-Kunststoff  
 PP plastic handle · Poignée PP-plastique

Schwarz · Black · Noir



**Geflügelschere Boca 10"**

Poultry shears · Ciseaux volaille

1 - 36

**15365** 4025457153655

Edelstahl · Stainless steel · Inox

POM Griff · POM handle · Poignée POM

Feststellbar  
 Lockable · Système de blocage

Schwarz · Black · Noir

# Acida

PP-Kunststoff · Messerstahl antihaftbeschichtet  
 PP plastic · Non-stick coated knife steel  
 PP-plastique · Lame acier anti-adhérent



Edelstahl  
 Stainless steel · Inox

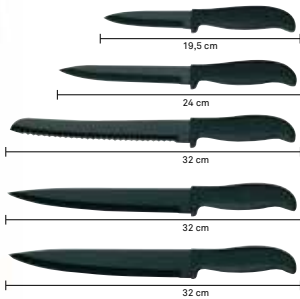

Küchenmesser 3,5"  
 Ausbeinmesser 5"  
 Brotmesser 8"  
 Fleischmesser 8"  
 Chefmesser 8"

Kitchen knife 3,5"  
 Boning knife 5"  
 Bread knife 8"  
 Carving knife 8"  
 Chef's knife 8"

Couteau d'office 3,5"  
 Couteau à désosser 5"  
 Couteau à pain 8"  
 Couteau viande 8"  
 Couteau chef 8"

Praktisches Innenleben aus vielen dünnen Kunststoffborsten. Diese verhindern, dass sich die Messer gegenseitig berühren und verkratzen. Die Messer lassen sich dabei an beliebigen Stellen positionieren. Außerdem kann man das Innenteil leicht herausnehmen, ausklopfen oder sogar in die Spülmaschine geben.

Practical inner consisting of multiple thin plastic rods. They prevent the blades from coming into contact with each other and becoming scratched. Position the knives at random. Simply remove the insides, tap them or even put them in the dishwasher.

Intérieur fait de petites tiges de résine, ce qui évite des rayures par frottement entre les couteaux. Les couteaux sont positionnables à souhait. L'intérieur est amovible et passe au lave vaisselle.



Messerblock  
 Knife block · Bloc de couteaux

1	-	4	📦
<b>11286</b>	4025457112867		
Weiß · White · Blanc			
6-teilig · 6 pieces · 6 pièces			



Messerblock  
 Knife block · Bloc de couteaux

1	-	4	📦
<b>11288</b>	4025457112881		
Grau · Grey · Gris			
6-teilig · 6 pieces · 6 pièces			



Messerblock  
 Knife block · Bloc de couteaux

1	-	4	📦
<b>11287</b>	4025457112874		
Schwarz · Black · Noir			
6-teilig · 6 pieces · 6 pièces			

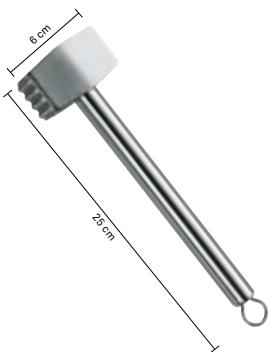

Edelstahl 18/10  
 Stainless steel · Inox

Fleischklopfer Noha  
 Meat tenderiser · Attendrisseur

1	6	36	📦
<b>11218</b>	4025457112188		
18/10 Edelstahl · Stainless steel · Inox			



Edelstahl 18/10  
 Stainless steel · Inox

Fleischklopfer Lova  
 Meat tenderiser · Attendrisseur

1	6	36	📦
<b>11220</b>	4025457112201		
18/10 Edelstahl · Stainless steel · Inox			
PP-Kunststoff · PP plastic · PP-plastique			
Schwarz · Black · Noir			

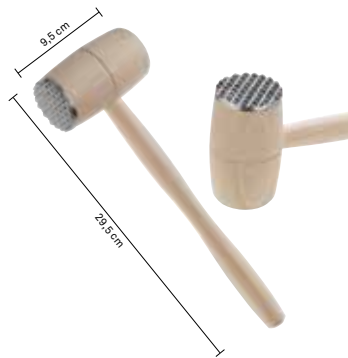

Fleischklopfer Maribor  
 Meat tenderiser · Attendrisseur

1	-	12	📦
<b>17302</b>	4025457173028		
Buche · Beech · Hêtre			
Metallaufsatz auf einer Seite Insert métallique sur un côté			



Mörser mit Stößel Paco  
 Mortar with pestle · Mortier avec pilon

1	-	12	📦
<b>10774</b>	4025457107740		
Porzellan · Porcelain · Porcelaine			
Weiß · White · Blanc			

# Spezialisten

Kochhilfen  
Culinary aids  
Aides culinaires



Edelstahl 18/10  
Stainless steel - Inox



Edelstahl 18/10  
Stainless steel - Inox



Edelstahl 18/10  
Stainless steel - Inox



Edelstahl 18/10  
Stainless steel - Inox



**Fleischthermometer Punkto**  
Meat thermometer · Thermomètre à viande  
1 15 30   
**15315** 4025457153150  
0 - 120 °



**Tee-/Gewürzkugel Aromi**  
Tea and spice infuser · Boule à thé/épices  
1 12 96   
**11304** 4025457113048

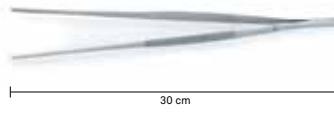

**Grill-/Bratenpinzette Pinca**  
Food tongs · Pince à aliment  
1 24 144   
**11467** 4025457114670



**Gemüsedämpfer Rosi**  
Vegetable steamer · Cuit vapeur  
1 12 36   
**19099** 4025457190995  
Faltbar · Foldable · Pliable  
Für Töpfe von: · Adjustable between:  
Ajustable: 14 - 24 cm Ø

**Ab 15 Stück im Verkaufsdisplay**  
From 15 pieces in the customer attractive display.  
A partir de 15 pièces dans un présentoir motivant.  
L30,5 / T19 / H26,5



Edelstahl  
Stainless steel - Inox



Edelstahl  
Stainless steel - Inox

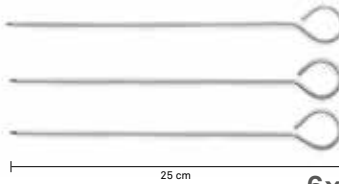

**Schaschlik-Spieße Pincho**  
Shashlik skewers · Piques à brochettes  
1 12 72   
**11214** 4025457112140

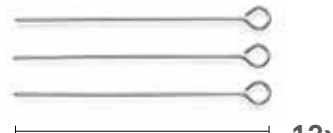

**Rouladennadeln Pincho**  
Roulades skewers · Piques à paupiettes  
1 12 288   
**11212** 4025457112126

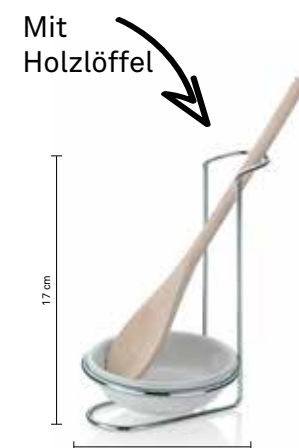

**Löffelablage Butler**  
Spoon holder · Repose cuillère  
1 - 18   
**17906** 4025457179068  
Keramik · Ceramic · Céramique  
Metall verchromt  
Metal chromed · Métal chromé  
Weiß · White · Blanc  
With wooden spoon  
Avec cuillère en bois



**Löffelablage Cuchara**  
Spoon holder · Repose cuillère  
1 - 18   
**16945** 4025457169458  
Porzellan · Porcelain · Porcelaine  
Weiß · White · Blanc



# Miko

Glas · Edelstahl 18/10  
Glass · Stainless steel 18/10  
Verre · Inox 18/10

Der Streuer hält die Gewürze lange frisch.  
Eine besondere Konstruktion sorgt für einen dauerhaft leichtgängigen Deckel.  
Die große Streufläche ermöglicht eine optimale Mengenregulierung.

The shaker keeps the spices fresh for a long time.  
A special construction for a light, light-weight lid.  
The large spreading area enables optimal volume regulation.

Le moulin permet de conserver les épices fraîches pendant longtemps.  
Une conception spéciale du couvercle assure un fonctionnement optimal et durable. La surface vaste de distribution permet une régulation optimale des quantités.



**NEW**



**NEW**



Edelstahl 18/10  
Stainless steel - Inox



Edelstahl 18/10  
Stainless steel - Inox

**Gewürzständer**  
Spice rack  
Étagère à épices

1 - 6

**11613** 4025457116131

5-teilig · 5 pièces · 5 pièces

**Display Multistreuer 70 ml**  
Display Multi purpose shaker  
Display Saupoudreuse multi-usages

12\* 48

**11612** 4025457116124

Display L20 cm/B20 / H21,5

**Salz-/Pfeffermühle Matteo 75 ml**  
Salt and pepper mill display  
Display Moulin sel & poivre

- 8\* 32

**11619** 4025457116193

Glas · Glass · Verre

Rutschfester Ring  
Non slip ring · Anneau antidérapant

Display L24,5 cm / B13 / H20,5

4x Pastelltürkis · 4x Opalgrau  
4x Pastel turquoise · 4x Opal grey  
4x Turquoise pastel · 4x Gris opal

**Salz-/Pfeffermühle Molino 200 ml**  
Salt and pepper mill display  
Display Moulin sel & poivre

- 8\* 32

**11665** 4025457116650

Glas · Glass · Verre

Display L30 cm / B15 / H21,5

# Kauri

Salz-/Pfeffermühle mit Keramikmahlwerk  
Salt and pepper mill mills with ceramic grinder  
Moulin à sel & poivre avec broyeur céramique

NEW

Edelstahl  
Stainless steel - Inox



Auch für getrocknete  
Gewürze



Mahlwerke aus Keramik sind verschleißarm, korrosionsbeständig und geschmacksneutral. Im Gegensatz zu Mahlwerken aus Stahl sind sie auch für Salz geeignet. Der Mahlgrad lässt sich stufenlos von fein bis grob einstellen.

Ceramic grinders are low-wear, corrosion-resistant and tasteless. In contrast to steel grinders, they are also suitable for salt. The grinding degree can be continuously adjusted from fine to coarse.

Les broyeurs en céramique s'usent peu, résistent à la corrosion et ont un goût neutre. Contrairement aux broyeurs en acier, ils sont également adaptés au sel. Le degré de broyage peut être réglé en continu, de fin à grossier.



Durch eine Einbuchtung im Holz lässt sich der Edelstahldeckel zum Befüllen der Mühle einfach entfernen.

An indentation in the wood allows the stainless steel lid to be simply removed to fill the grinder.

Le couvercle en acier inoxydable se retire facilement du moulin.

## Salz-/Pfeffermühlen Menage

Salt and pepper mills menage

Ménagère moulin à sel & poivre

1 - 6 

12193 4025457121937

Buche · Beech · Hêtre

12198 4025457121982

Akazienholz · Acacia · Acacia

Can also be used as a spice mill  
Not suitable for use with chilli  
Utilisable comme moulin à épices sauf Chili



# Kauri

Salz-/Pfeffermühle mit Keramikmahlwerk  
Salt and pepper mill mills with ceramic grinder  
Moulin à sel & poivre avec broyeur céramique



Befüllung von unten  
Fill from below  
Remplissage par le bas



**Salz-/Pfeffermühle**  
Salt and pepper mill  
Moulin à sel & poivre

1	-	16	☒
<b>12190</b>	4025457121906		
Buche · Beech · Hêtre			
<b>12195</b>	4025457121951		
Akazienholz · Acacia · Acacia			



**Salz-/Pfeffermühle**  
Salt and pepper mill  
Moulin à sel & poivre

1	-	16	☒
<b>12191</b>	4025457121913		
Buche · Beech · Hêtre			
<b>12196</b>	4025457121968		
Akazienholz · Acacia · Acacia			



**Salz-/Pfeffermühle**  
Salt and pepper mill  
Moulin à sel & poivre

1	-	16	☒
<b>12192</b>	4025457121920		
Buche · Beech · Hêtre			
<b>12197</b>	4025457121975		
Akazienholz · Acacia · Acacia			



**Salz-/Pfeffermühle**  
Salt and pepper mill  
Moulin à sel & poivre

1	-	16	☒
<b>12194</b>	4025457121944		
Buche · Beech · Hêtre			
Kunststoff · Plastic · Plastique			
<b>12199</b>	4025457121999		
Akazienholz · Acacia · Acacia			
Kunststoff · Plastic · Plastique			



**CrushGrind®**



## CrushGrind® 25:

kraftvolles und präzises  
Keramik-Mehrzweckmahlwerk.

- Abrieb- und korrosionsfrei
- Mahlgrad individuell einstellbar
- Einfache Befüllung von oben
- Leicht zu reinigen

Auch für getrocknete  
Gewürze

## CrushGrind® 25:

powerful and precise  
multi-purpose ceramic grinder.

- Resistant to abrasion and corrosion
- Grinding coarseness can be individually adjusted
- Easy filling from the top
- Easy to clean

## CrushGrind® 25:

broyeur céramique polyvalent  
puissant et précis.

- Résistance à l'usure et à la corrosion
- Degré de broyage réglable
- Remplissage facile depuis le haut
- Entretien facile



## Salz-/Pfeffermühle Kaja

Salt and pepper mill · Moulin à sel & poivre

1	-	16	☒
<b>11786</b>	4025457117862		
<b>11787</b>	4025457117879		
<b>11788</b>	4025457117886		

Can also be used as a spice mill.  
Peut être utilisé également comme moulin à épices.

Akazienholz · Acacia · Acacia

# Kaja

Akazienholz  
Acacia  
Acacia



# Buffalo

Aluguss antihaftbeschichtet

Cast aluminum non-stick coating

Revêtement antiadhésif en fonte d'aluminium



Die Hamburgerpresse wird mit einer kleinen Rezeptbroschüre & 50 Antihaftpapieren geliefert.

With 3 delicious recipes.

50 x Non-stick paper.

Avec 3 délicieuses recettes.

50x Papier anti-adhésif.



Ab 12 Stück im Verkaufsdisplay

From 12 pieces in a display



Présentoir dès 12 pièces

L39,5 / T20 / H26,5



## Hamburgerpresse Buffalo

Burger press  
Presse à hamburger

1 12 24  

11715 4025457117152

Aluguss antihaftbeschichtet  
Cast aluminum non-stick coating  
Revêtement antiadhésif en fonte d'aluminium

Hamburger 11 cm Ø

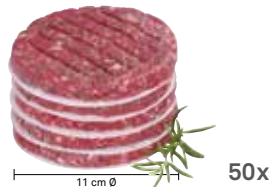

## Antihaftpapier Buffalo

Non-stick paper  
Papier anti-adhésif

1 12 144  For 11715

11717 4025457117176

50 Blatt · 50 Sheets · 50 Feuilles

**Gewachstes Antihaftpapier sorgt für optimales Lösen der Patties.**

Waxed for best extraction of the patties.

Ciré pour l'extraction optimale des steacks.



Edelstahl 18/10  
Stainless steel · Inox

## Hamburger-Spieße Sammy

Hamburger skewers  
Piques pour hamburger

1 6 72 

19219 4025457192197

18/10 Edelstahl · Stainless steel · Inox

4 verschiedene Motive  
4 different shapes  
4 motifs différents





# Antonietta

Damit gelingt die perfekte Pasta  
This makes the perfect pasta  
Pour des pâtes parfaites



Lasagne  
14,5 cm



Fettuccine  
6,6 mm



Spaghetti  
2 mm

### Walzen aus Chromstahl mit hochwertiger Oberflächenveredelung

Chromium steel rollers with high-grade finish  
Rouleaux en acier chromé avec une finition de surface de haute qualité



**Rutschfester Sockel**  
Non-slip base  
Base anti dérapante

**Extra hohe Tischklemme (7 cm)**  
Ultra-high table clamp (7 cm)  
Pince réglable de table (7 cm)

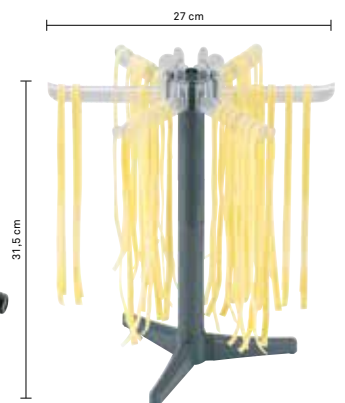

**Gehäuse:** Chromstahl, Edelstahl **Walzen:** Chromstahl **Teigbreite:** 14,5 cm  
**Teigdicke:** 9 verschiedene Einstellungen von 0,3 mm bis 3 mm

Housing: Chrome + stainless steel,  
Rollers: Chrome-plated steel, Max. dough width: 14,5 cm  
Max. dough thickness: 9 different settings from 0.3 mm to 3 mm

Extérieur: Chrome et acier inoxydable,  
Rouleaux: acier chromé, Largeur de la pâte: 14,5 cm  
Epaisseur de la pâte: 9 possibilités 0,3 mm à 3 mm

### Nudelmachine Antonietta

Pasta maker · Machine à pâtes

1 - 4

**11720** 4025457117206

Für 3 Pasta-Sorten  
For 3 types of pasta  
Pour 3 sortes de pâtes

### Pastatrockner Adriana

Pasta dryer · Sècheur de pâte

1 - 30

**11723** 4025457117237

ABS-Kunststoff  
ABS plastic · ABS-plastique

Anthrazit · Anthracite · Anthracite

# Profi

Edelstahl  
Stainless steel  
Inox



Edelstahl  
Stainless steel - Inox

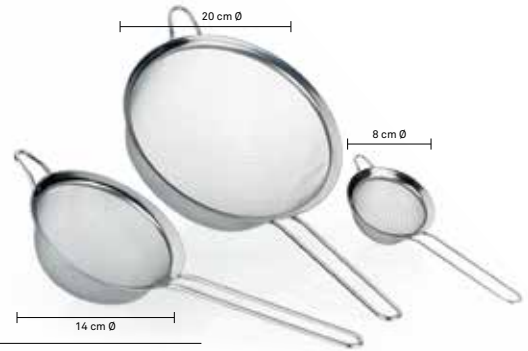

**Küchensieb-Set Profi**  
Mesh sieve set · Set passoire cuisine

1 - 8

**11074** 4025457110740

3 Stück · 3 pieces · 3 pièces

8/14/20 cm Ø

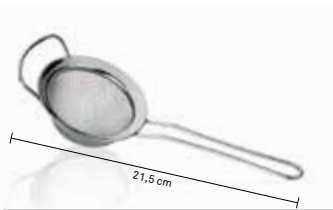

**Kaffeesieb 8 cm Ø**  
Coffee sieve · Passoire à café

1 10 100

**19054** 4025457190544



**Küchensieb 10 cm Ø**  
Mesh colander · Passoire cuisine

1 10 100

**19055** 4025457190551

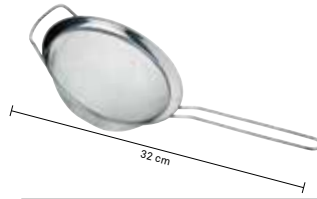

**Küchensieb 16 cm Ø**  
Mesh colander · Passoire cuisine

1 6 72

**19056** 4025457190568

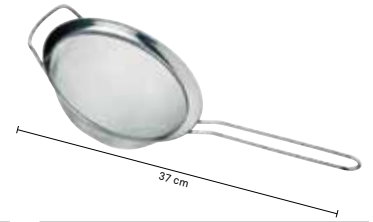

**Küchensieb 20 cm Ø**  
Mesh colander · Passoire cuisine

1 6 36

**19058** 4025457190582

# Dry / Mailin

PP-Kunststoff  
PP plastic  
PP-plastique



**Salatschleuder 4,4 L**  
Salad spinner · Essoreuse à salade

1 - 6

**11906** 4025457119064

Grün · Green · Vert



**Salatschleuder 4,4 L**  
Salad spinner · Essoreuse à salade

1 - 6

**11907** 4025457119071

Grau · Grey · Gris



**Salatschleuder Mailin 4,3 L**  
Salad spinner · Essoreuse à salade

1 - 12

**12102** 4025457121029

Pastellgrün / Opalgrau  
Pastel green / Opal grey  
Vert pastel / Gris opal



**Salatschleuder Mailin 4,3 L**  
Salad spinner · Essoreuse à salade

1 - 12

**12103** 4025457121036

Pastellblau / Opalgrau  
Pastel blue / Opal grey  
Bleu pastel / Gris opal



# Unsere Extraklasse

Edelstahl 18/10  
Stainless steel 18/10  
Inox 18/10



**Küchensieb Athos 0,7 mm**  
Strainer · Passoires de cuisine

1	4	16	☞
B27,5 / H14,5 / Ø20			
<b>11980</b>	4025457119804		
1	4	12	☞
B32,5 / H15,5 / Ø24			
<b>11981</b>	4025457119811		
Außen matt, innen glänzend Matt outside, polished inside Extérieur mat, intérieur brillant			



**Schüssel Athos 0,7 mm**  
Bowl · Jatte

1	4	16	☞
H11 / Ø18			
<b>11975</b>	4025457119750		
H13 / Ø20 cm			
<b>11976</b>	4025457119767		
1	4	12	☞
H14 / Ø24			
<b>11977</b>	4025457119774		
H16 / Ø26 cm			
<b>11978</b>	4025457119781		
Außen matt, innen glänzend Matt outside, polished inside Extérieur mat, intérieur brillant			



**Schüssel Pina**  
Bowl · Jatte

1	4	16	☞
H8,5 / Ø21			
<b>11971</b>	4025457119712		
H9,5 / Ø24			
<b>11972</b>	4025457119729		
H10,5 / Ø27			
<b>11973</b>	4025457119736		
H11,5 / Ø30			
<b>11974</b>	4025457119743		
Außen matt, innen glänzend Matt outside, polished inside Extérieur mat, intérieur brillant			



**Universalsieb Ares 0,4 mm**  
Universal sieve · Tamis universel

1	-	8	☞
<b>11982</b>	4025457119828		
Matt · Matt · Mat			
H9,5 / Ø23,5			





Bambus bietet neben der attraktiven Naturoptik viele Vorteile gegenüber anderem Holz. Es gehört zu den schnellwachsenden Pflanzen, ist härter und dichter als Buchenholz und steht sowohl für Langlebigkeit und Strapazierfähigkeit, wie auch für einfache Pflege. Ein modernes und vielgeschätztes Material, mit antibakteriellen Eigenschaften, das über Jahre hinweg hält und nebenbei die Messerklingen schont. Bambus nimmt keine lästigen Gerüche und Aromen an und dank dem leichten Gewicht des Holzes, ist es vielseitig einsetzbar.

Apart from its attractive natural appearance, bamboo has many advantages over other types of wood. It is one of the fastest-growing plants and is harder and denser than beech wood, which makes it durable and hard-wearing, as well as easy-care.

A modern, much-valued material with antibacterial properties that lasts for many years, and one that is also gentle on knife blades. Bamboo does not absorb troubling odours and aromas and, thanks to the wood's light weight, it has many versatile uses.

Outre son aspect naturel attrayant, le bambou présente de nombreux avantages par rapport à d'autres types de bois. Il fait partie des plantes à croissance rapide, il est plus dur et plus dense que le bois de hêtre et est synonyme de longévité et de durabilité ainsi que de facilité d'entretien.

Un matériau moderne et très apprécié, avec des propriétés antibactériennes, qui dure des années et protège également les lames des couteaux. Le bambou n'absorbe pas les odeurs et les arômes désagréables et grâce à la légèreté du bois, il est polyvalent.



# Kenina

Bambus · Auffangschalen aus Edelstahl 18/10

Bamboo · 18/10 stainless steel drip trays

Bambou · Récupérateurs en acier inoxydable 18/10



Praktische Einsätze zum Sammeln des Schneidguts bzw. für Schneideabfälle erleichtern das Arbeiten in der Küche.

Die 18/10 Edelstahleinsätze sind sogenannte Gastronormbehälter, welche sich durch eine hohe Qualität und Lebensdauer auszeichnen.

Selbstverständlich sind die Behälter spülmaschinengeeignet und können auch als Auflaufform verwendet werden.

Sicherer Stand durch GummifüÙe an der Unterseite des Schneidbretts.

Practical inserts to collect cut food or food waste make light work of cooking. The 18/10 stainless steel inserts are Gastronorm-standard containers and stand out with their high quality and durability. Of course, the containers are dishwasher-safe and can also be used as baking dishes. Slip-resistant, thanks to rubber feet on the underside of the cutting board.

Des inserts pratiques pour la collecte des aliments à découper ou pour des déchets facilitent le travail en cuisine. Les inserts en acier inoxydable 18/10 sont parfaits pour le contact alimentaire et se caractérisent par une qualité et une durabilité élevées. Bien entendu, les récipients passent au lave-vaisselle et peuvent également être utilisés comme plats.

La sécurité est assurée par des pieds en caoutchouc sur la face inférieure de la planche à découper.

NEW



NEW

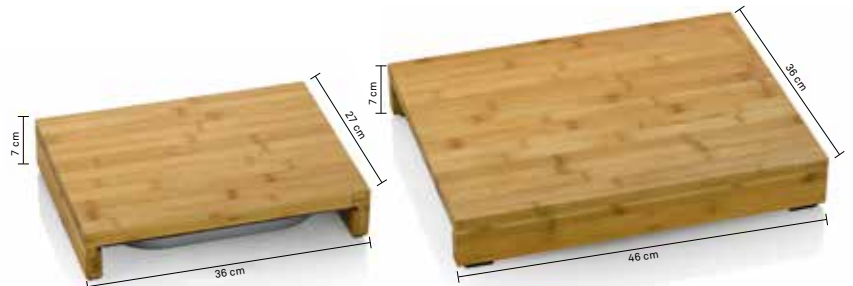

### Schneidebrett Kenina

Shopping board · Planche à découper

1 - 2

12552 4025457125522

Rutschfeste GummifüÙe  
Non-slip rubber feet  
Pieds en caoutchouc antidérapants

1 Einsatz · 1 insert · 1 panier  
1x L33 / B26,5 / H4cm



### Schneidebrett Kenina

Shopping board · Planche à découper

1 - 2

12553 4025457125539

Rutschfeste GummifüÙe  
Non-slip rubber feet  
Pieds en caoutchouc antidérapants

3 Einsätze · With 3 insert · Avec 3 panier  
1x L32,5 / B17,5 / H4 cm  
2x L6,5 / B16 / H4cm



Beidseitig verwendbar.

Eine Seite mit Saftrille.

Reversible - Utilisable des deux côtés.

Un côté avec récupérateur de jus.



Beidseitig verwendbar

Reversible

Utilisable recto-verso

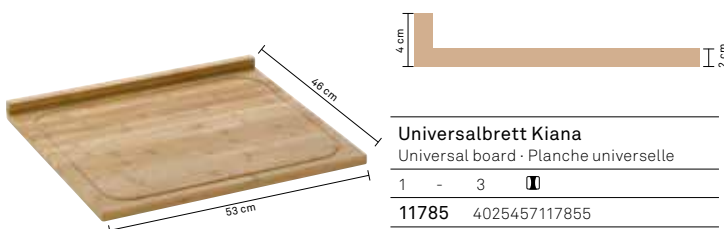

### Universalbrett Kiana

Universal board · Planche universelle

1 - 3

11785 4025457117855

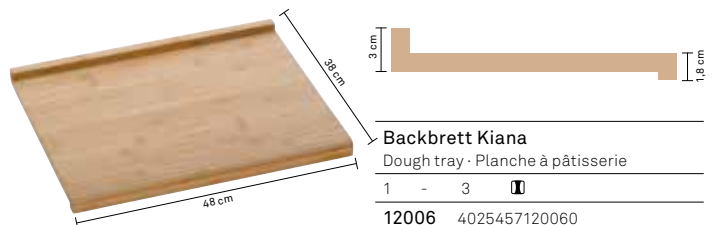

### Backbrett Kiana

Dough tray · Planche à pâtisserie

1 - 3

12006 4025457120060



Auch als Auflaufform  
geeignet





# Katana

Bambus  
Bamboo  
Bambou



3x

**Schneidebrett-Set**  
Chopping board set · Set planche à découper

1 - 6

**12009** 4025457120091

20 x 15 cm, 1,5 cm h  
31 x 23 cm, 1,5 cm h  
38 x 29 cm, 1,5 cm h

3-teilig · 3 pieces · 3 pièces



15,5 cm

24 cm Ø

**Käseglocke**  
Cheese cover · Cloche à fromage

1 - 8

**11874** 4025457118746

Deckel: Glas  
Cover: Glass  
Couvercle: Verre



3x

**Schneidebrett-Set**  
Chopping board set · Set planche à découper

1 - 8

**12014** 4025457120145

3-teilig · 3 pieces · 3 pièces

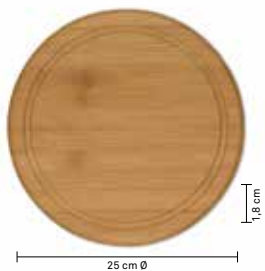

1,8 cm

25 cm Ø

**Schneidebrett**  
Chopping board · Planche à découper

1 - 8

**12007** 4025457120077

Mit Safrille  
With juice groove  
Avec récupérateur de jus



1,8 cm

30 cm Ø

**Schneidebrett**  
Chopping board · Planche à découper

1 - 8

**12008** 4025457120084

Mit Safrille  
With juice groove  
Avec récupérateur de jus



45,5 cm

30,5 cm

2 cm

**Schneidebrett**  
Chopping board · Planche à découper

1 - 6

**11682** 4025457116827

Mit Safrille  
With juice groove  
Avec récupérateur de jus

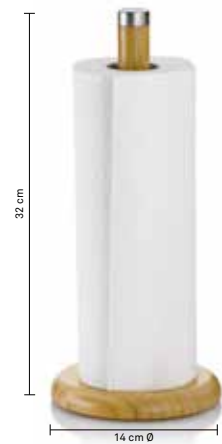

32 cm

14 cm Ø

**Küchenrollenhalter**  
Kitchen roll holder · Support à essuie-tout

1 - 12

**11873** 4025457118739



# Holzbretter

Bambus  
Bamboo  
Bambou



**Schneidebrett**  
Chopping board · Planche à découper

1	-	24	📦
<b>11870</b>	4025457118708		



**Schneidebrett**  
Chopping board · Planche à découper

1	-	18	📦
<b>11871</b>	4025457118715		



**Schneidebrett**  
Chopping board · Planche à découper

1	-	12	📦
<b>11872</b>	4025457118722		



**Schneidebrett Klara**  
Shopping board · Planche à découper

1	-	8	📦
<b>12516</b>	4025457125164		
PP-Kunststoff · PP plastic · Plastique PP			



**Universalbrett Kiana**  
Universal board · Planche universelle

1	-	3	📦
<b>12010</b>	4025457120107		

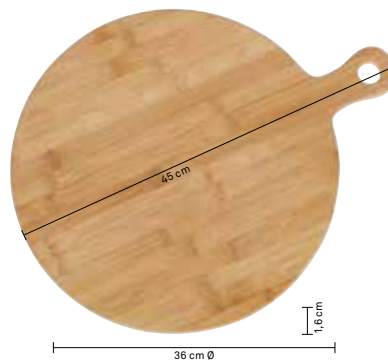

**Servierbrett Nino**  
Serving board · Planche

1	-	8	📦
<b>12024</b>	4025457120244		

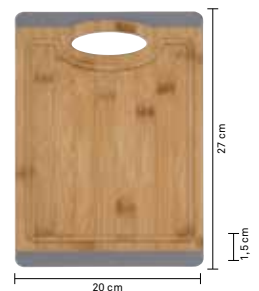

**Schneidebrett Gary**  
Chopping board · Planche à découper

1	-	12	📦
<b>12300</b>	4025457123009		
Silikon Grau · Silicone Grey · Silicone Gris			

# Perfekt serviert

Käsehobel und Schalen-Sets  
 Cheese slicer and bowl sets  
 Girolle à fromage et set coupelles

Schweizer Käse Spezialität  
 Tête de Moine

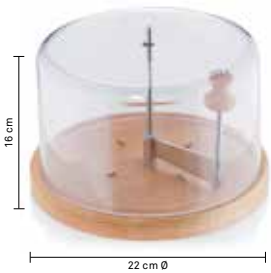

**Käsehobel mit Haube Planum**  
 Cheese scraper · Girolle à fromage

---

1 - 6

---

**77080** 4025457770807

---

Edelstahl · Stainless steel · Inox

---

Klinge Edelstahl 18/10

---

Buche · Beech · Hêtre

---

AS-Kunststoff · AS plastic · AS-plastique

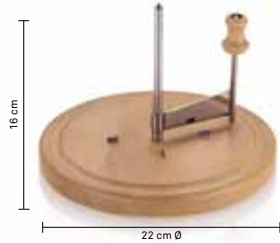

**Käsehobel Luxus**  
 Cheese scraper · Girolle à fromage

---

1 - 12

---

**77085** 4025457770852

---

Edelstahl · Stainless steel · Inox

---

Klinge Edelstahl 18/10

---

Buche · Beech · Hêtre



**Schalen-Set Philipa**  
 Bowl set · Set coupelles

---

1 - 12

---

**12260** 4025457122606

---

Porzellan · Porcelain · Porcelaine

---

Bambus · Bamboo · Bambou

---

4-teilig · 4 pieces · 4 pièces



**Schalen-Set Philipa**  
 Bowl set · Set coupelles

---

1 - 6

---

**12261** 4025457122613

---

Porzellan · Porcelain · Porcelaine

---

Bambus · Bamboo · Bambou

---

4-teilig · 4 pieces · 4 pièces

Servieren und Trinken · Serving and drinking · Servir et boire

# AUFGETISCHT







**NEW**

## Fontana

Borosilikatglas hitzebeständig  
Borosilicate glass heat resistant  
Verre borosilicate: résistant à la chaleur

Edelstahl 18/10  
Stainless steel · Inox



**Milchkrug 700 ml**  
Milk jug · Broc à lait  
1 - 36 H12,5 / Ø9 cm  
**12390** 4025457123900



**Milchkännchen 200 ml**  
Milk jug · Pot à lait  
1 - 24 H11 / Ø8 cm  
**12391** 4025457123917



**Zuckerdose**  
Sugar bowl · Sucrier  
1 - 24 H7 / Ø9 cm  
**12392** 4025457123924

Doppelwandiges Glas:  
Hält das Getränk warm,  
und die Finger kühl.

Double-walled glass:  
Keeps the drink warm  
and fingers cool.

Verre à double paroi:  
Garde la boisson au chaud  
et les doigts refroidissent.



**2x**

**Espressoglas 60 ml**  
Espressoglass · Verre Espresso  
1 - 24 H7 / Ø6 cm  
**12403** 4025457124037



**2x**

**Cappuccinoglas 180 ml**  
Cappuccinoglass · Verre Cappuccino  
1 - 24 H9,5 / Ø7,5 cm  
**12404** 4025457124044



**2x**

**Latte Macchiato Glas 250 ml**  
Lattemacchiatoglass · Verre Latte Macchiato  
1 - 24 H12 / Ø8 cm  
**12405** 4025457124051

Auch für Café Crème geeignet  
Also suitable for Café Crème  
Adaptée pour Café Crème aussi



**2x**

**Wasserglas-Set 250 ml**  
Water glass · Verre à eau  
1 - 24 H9,5 / Ø8 cm  
**12417** 4025457124174



**Saftkrug 1,5 L**  
Juice jug · Carafe à jus  
1 - 9 H25,5 / Ø11 cm  
**12418** 4025457124181



**Teekanne 1,2 L**  
Teapot · Théière  
1 - 12 H21 / Ø13,5 cm  
**12395** 4025457123955



**Kaffeebereiter 1,0 L**  
Coffee maker · Cafetière à piston  
1 - 12 H22 / Ø12 cm  
**12394** 4025457123948

# Durstlöscher perfekt inszeniert

Glas  
Glass  
Verre



In diesen Glaskaraffen schmecken die Getränke noch besser. Schönes Design – starker Preis.

The drinks taste even better in these glass carafes. Nice design - great price.

Les boissons ont encore meilleur goût dans ces carafes en verre. Beau design - bon prix.



Wein-Dekantierkaraffe Lorena 1,7 L  
Wine decanter carafe  
Carafe à décanter le vin

1 - 6   
12151 4025457121517

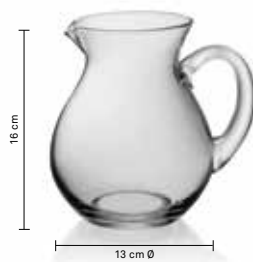

Saft-/ Wasserkrug Roberta 1,0 L  
Juice-/ water jug  
Pichet à jus de fruits – Pichet à eau

1 - 12   
12154 4025457121548

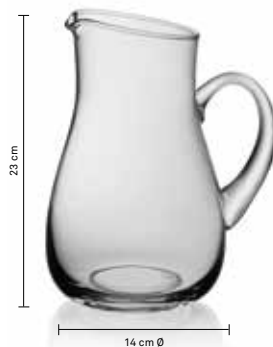

Saft-/ Wasserkrug Antonia 1,7 L  
Juice-/ water jug  
Pichet à jus de fruits – Pichet à eau

1 - 9   
12155 4025457121555



Saft-/ Wasserkrug Sofia 1,8 L  
Juice-/ water jug  
Pichet à jus de fruits – Pichet à eau

1 - 8   
12152 4025457121524



## Luna

Borosilikatglas hitzebeständig · Edelstahl 18/10  
 Borosilicate glass heat resistant · Stainless steel 18/10  
 Verre borosilicate résistant à la chaleur · Inox 18/10

Ausgeklügeltes Ausgießsystem –  
 geschlossen, komplett geöffnet oder mit Sieblöchern  
 Sophisticated pouring system – closed, fully open or perforated  
 Verre borosilicate, bec verseur et bouchon filtrant



**Universalkanne 1,2 L**

Universal pot · Pot universel

1 - 12

**12535** 4025457125355

Matt · Matt · Mat



**Universalkanne 1,5 L**

Universal pot · Pot universel

1 - 12

**12536** 4025457125362

Matt · Matt · Mat



## Pitcher

Borosilikatglas hitzebeständig · Edelstahl 18/10  
 Borosilicate glass heat resistant · Stainless steel 18/10  
 Verre borosilicate résistant à la chaleur · Inox 18/10

Öffnung im Deckel – für ein einfaches Ausgießen.  
 The hole in the lid ensures simple pouring.  
 Le trou dans le couvercle permet de verser facilement.



**Saftkrug 1,0 L**

Juice jug · Pichet à jus

1 - 12

**11397** 4025457113970

Borosilikatglas  
 Borosilicate glass · Verre borosilicate

Matt · Matt · Mat



**Saftkrug 1,6 L**

Juice jug · Pichet à jus

1 - 12

**11398** 4025457113987

Borosilikatglas  
 Borosilicate glass · Verre borosilicate

Matt · Matt · Mat





kela

kela

# Italia

Aluminium  
Aluminium  
Aluminium

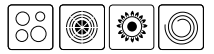

**Espressokanne 150 ml**  
Espresso maker · Percolateur

1 - 30

**10590** 4025457105906



**Espressokanne 300 ml**  
Espresso maker · Percolateur

1 - 20

**10591** 4025457105913



**Espressokanne 450 ml**  
Espresso maker · Percolateur

1 - 10

**10592** 4025457105920



**Espressokanne**  
Espresso maker · Percolateur

1 - 30

**10550** 4025457105500

Beige · Beige · Beige



**Espressokanne**  
Espresso maker · Percolateur

1 - 20

**10551** 4025457105517

Beige · Beige · Beige



**Espressokanne**  
Espresso maker · Percolateur

1 - 10

**10552** 4025457105524

Beige · Beige · Beige



**Espressokanne**  
Espresso maker · Percolateur

1 - 30

**10553** 4025457105531

Schwarz · Black · Noir



**Espressokanne**  
Espresso maker · Percolateur

1 - 20

**10554** 4025457105548

Schwarz · Black · Noir



**Espressokanne**  
Espresso maker · Percolateur

1 - 10

**10555** 4025457105555

Schwarz · Black · Noir



**Ersatzdichtung Bella**  
Replacement gasket  
Joint souple de rechange

1 100 500 6,5 cm Ø

**10584** 4025457105845

1 100 500 7 cm Ø

**10585** 4025457105852

1 100 500 8 cm Ø

**10586** 4025457105869

Für · For · Pour: Latina, Italia



## Latina

18/10 Edelstahl · Unterteil Edelstahl · Induktionsfähig  
 18/10 Stainless steel · Stainless steel base · Induction hobs  
 18/10 Inox · Dessous en acier inoxydable · Compatible induction



**Espressokanne 200 ml**  
 Espresso maker · Percolateur

1 - 12   
**10835** 4025457108358



**Espressokanne 300 ml**  
 Espresso maker · Percolateur

1 - 12   
**10836** 4025457108365

## Verona

Borosilikatglas hitzebeständig · PP Kunststoff  
 Borosilicate glass heat resistant · PP plastic  
 Verre borosilicate résistant à la chaleur · PP plastique

Kaffeepress-System  
 Siebeinsatz Edelstahl 18/10

Coffee pressing system  
 Infuser: 18/10 stainless steel

Cafetière à piston  
 Filtre: 18/10 Inox



**Kaffeebereiter 1,0 L**  
 Coffee maker · Cafetière à piston

1 - 12   
**10869** 4025457108693  
 Rot · Red · Rouge



**Kaffeebereiter 1,0 L**  
 Coffee maker · Cafetière à piston

1 - 12   
**10879** 4025457108792  
 Blau · Blue · Bleu



**Kaffeebereiter 1,0 L**  
 Coffee maker · Cafetière à piston

1 - 12   
**10884** 4025457108846  
 Grau · Grey · Gris

## Vinci

Borosilikatglas hitzebeständig · Edelstahl  
 Borosilicate glass heat resistant · Stainless steel  
 Verre borosilicate résistant à la chaleur · Inox

Kaffeepress-System · Siebeinsatz Edelstahl 18/10  
 Coffee pressing system · Infuser: 18/10 stainless steel  
 Cafetière à piston · Filtre: 18/10 Inox



**Kaffeebereiter 0,35 L**  
 Coffee maker · Cafetière à piston

1 - 12

**10807** 4025457108075

**Kaffeebereiter 0,95 L**  
 Coffee maker · Cafetière à piston

1 - 12

**10808** 4025457108082



Länger Wärme  
im Inneren

## Venecia

Borosilikatglas hitzebeständig · Edelstahl  
 Borosilicate glass heat resistant · Stainless steel  
 Verre borosilicate résistant à la chaleur · Inox



**Kaffeebereiter 0,6 L**  
 Coffee maker · Cafetière à piston

1 - 12

**10851** 4025457108518

**Kaffeebereiter 1,0 L**  
 Coffee maker · Cafetière à piston

1 - 12

**10852** 4025457108525

## Roma

Borosilikatglas hitzebeständig · PP Kunststoff  
 Borosilicate glass heat resistant · PP plastic  
 Verre borosilicate résistant à la chaleur · PP plastique



**Kaffeebereiter 0,6 L**  
 Coffee maker · Cafetière à piston

1 - 12

**10848** 4025457108488

**Kaffeebereiter 1,0 L**  
 Coffee maker · Cafetière à piston

1 - 12

**10849** 4025457108495

# Herta

Edelstahl 18/10  
Stainless steel 18/10  
Inox 18/10



**Milchkrug Herta**  
Milk cup · Broc à lait

1	-	24	📦	350 ml
<b>10900</b>				4025457109003



**Milchkrug Herta**  
Milk cup · Broc à lait

1	-	12	📦	700 ml
<b>10901</b>				4025457109010
Glänzend · Bright · Brillant				

# Maito

ABS-Kunststoff  
ABS plastic  
ABS-plastique

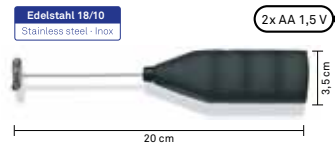

**Milchaufschäumer Maito**  
Milk frother · Mousseurs à lait

1	-	120	📦	
<b>11496</b>				4025457114960
ABS-Kunststoff · ABS plastic · ABS-plastique				
Batteriebetrieben · Ohne Batterie Battery operated · Batteries not included Alimenté par pile · Sans piles				



**Display Milchaufschäumer Maito**  
Milk frother display · Display mousseurs à lait

1	-	8	📦	
<b>11495</b>				4025457114953
ABS-Kunststoff · ABS plastic · ABS-plastique				
Batteriebetrieben · Ohne Batterie Battery operated · Batteries not included Alimenté par pile · Sans piles				



**Tee-Box Relax**  
Tea Box · Boîte pour le thé

1	-	12	📦	
<b>12513</b>				4025457125133
L21 / B16 / H9				
Acryl · Acrylic · Acrylique				
Bambus · Bamboo · Bambou				

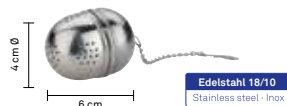

**Tee-Ei Vision 4 cm Ø**  
Tea egg · Boule à thé

1	12	144	📦	
<b>15314</b>				4025457153143



**Tee-/Gewürzkugel Profi**  
Tea and spice ball · Boule à thé/épices

1	12	576		5 cm Ø
<b>19051</b>				4025457190513
1	12	288		6 cm Ø
<b>19052</b>				4025457190520

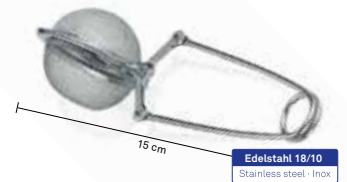

**Tee-/Gewürzzange Profi**  
Tea and spice tongs · Pince à thé/épices

1	12	288		4,5 cm Ø
<b>19050</b>				4025457190506
1	12	288		6 cm Ø
<b>19043</b>				4025457190438



# Carolina

Mit Keramikmahlwerk  
Coffee grinder  
Broyeur conique céramique

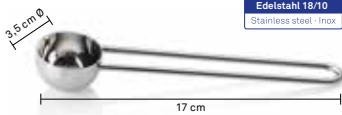

Edelstahl 18/10  
Stainless steel · Inox

## Kaffeemaßlöffel Carlotta

Coffee measure spoon · Mesure café

1 12 144

19034 4025457190346



## Vorratsglas Carolina

Storage jar · Bol collecteur en verre

1 - 24

11806 4025457118067

Passend für 11809,11808  
Suitable for 11809,11808  
Conçu pour 11809,11808



Edelstahl 18/10  
Stainless steel · Inox

## Kaffeemühle Carolina

Coffee grinder · Moulin à café

1 - 16

11809 4025457118098

Schwarz · Black · Noir  
Matt · Mat · Mat



Edelstahl 18/10  
Stainless steel · Inox

## Kaffeemühle Carolina

Coffee grinder · Moulin à café

1 - 16

11808 4025457118081

Matt · Mat · Mat



### Mahlgrad einstellbar

Grinding degree adjustable  
Degré de broyage réglable

1-1,5 Espresso  
3,5-4 Filter · Filtre  
6-7 Cold Brew  
7,5-8 Press-System



### Leicht zu befüllen

Easy to fill  
Facile à remplir



## Kaffeefilter S

Coffee filter · Filtre à café

1 - 18

12490 4025457124907

Weiß · White · Blanc

Passend für Filterpapier Gr. 2  
Suitable for filter paper no. 2  
Pour filtres à café n°. 2



## Kaffeefilter S

Coffee filter · Filtre à café

1 - 18

12491 4025457124914

Schwarz · Black · Noir

Passend für Filterpapier Gr. 2  
Suitable for filter paper no. 2  
Pour filtres à café n°. 2



## Kaffeefilter L

Coffee filter · Filtre à café

1 - 12

12492 4025457124921

Weiß · White · Blanc

Passend für Filterpapier Gr. 4  
Suitable for filter paper no. 4  
Pour filtres à café n°. 4



## Kaffeefilter L

Coffee filter · Filtre à café

1 - 12

12493 4025457124938

Schwarz · Black · Noir

Passend für Filterpapier Gr. 4  
Suitable for filter paper no. 4  
Pour filtres à café n°. 4

# Excelsa

Porzellan  
Porcelain  
Porcelaine

# Cesena

Borosilikatglas · Doppelwandig  
 Borosilicate glass · Double-walled  
 Verre en borosilicate double paroi



2x

Espressoglas 80 ml				
Espressoglass · Verre Espresso				
1	-	24	☒	H6,5 / Ø6 cm
12410	4025457124105			



2x

Cappuccinoglas 200 ml				
Cappuccinoglass · Verre Cappuccino				
1	-	24	☒	H8,5 / Ø8 cm
12411	4025457124112			



2x

Latte Macchiato Glas 300 ml				
Lattemacchiatoglass · Verre Latte Macchiato				
1	-	24	☒	H12 / Ø8,5 cm
12412	4025457124129			

# Mattia

Keramik matt  
Ceramics matt  
C ramique mat



2x

**Espresso-Set 50 ml**  
Espresso-set - Set d'espresso

1 - 18 H6,5 /  12 cm

12750 4025457127502

Schwarz - Black - Noir



2x

12751 4025457127519

Grau - Grey - Gris



2x

12755 4025457127557

Braun - Brown - Brun



2x

12754 4025457127540

Blau - Blue - Bleu



2x

12752 4025457127526

Rot - Red - Rouge



2x

12753 4025457127533

T rkis - Turquoise - Turquoise



2x **NEW**

**Tassen-Set 300 ml**  
Cups-set - Set coupes

1 - 16 H11 /  7,5 cm

12756 4025457127564

Schwarz - Black - Noir



2x **NEW**

12757 4025457127571

Grau - Grey - Gris



2x

12758 4025457127588

Braun - Brown - Brun



Einfach stapelbar



# Cylon

Borosilikatglas hitzebeständig · Edelstahl  
 Borosilicate glass heat resistant · Stainless steel  
 Verre borosilicate résistant à la chaleur · Inox



**Teekanne 1,2 L**

Teapot · Théière

1 - 12

**16922** 4025457169229



**Teekanne 1,5 L**

Teapot · Théière

1 - 12

**11456** 4025457114564

# Ancona

Edelstahl 18/10  
 Stainless steel 18/10  
 Inox 18/10

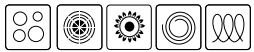

**Teekanne 0,9 L**

Teapot · Théière

1 - 6

**11355** 4025457113550

Glänzend · Bright · Brillant



**Teekanne 1,7 L**

Teapot · Théière

1 - 6

**11356** 4025457113567

Glänzend · Bright · Brillant

## Aurora

Borosilikatglas hitzebeständig · Edelstahl  
 Borosilicate glass heat resistant · Stainless steel  
 Verre borosilicate résistant à la chaleur · Inox

Kein  
 Nachtropfen



**Teekanne 1,3 L**  
 Teapot · Thière  
 1 - 12   
 16940 4025457169403



**Teekanne 1,8 L**  
 Teapot · Thière  
 1 - 12   
 16941 4025457169410



Abnehmbarer Kunststoffring  
 Plastic ring removable  
 Le socle en plastique amovible



**Teekanne 0,7 L**  
 Teapot · Thière  
 1 - 12   
 11457 4025457114571



**Teekanne 1,0 L**  
 Teapot · Thière  
 1 - 12   
 11458 4025457114588



## Auron

Borosilikatglas hitzebeständig · PP-Kunststoff · Schwarz  
 Borosilicate glass heat resistant · PP plastic · Black  
 Verre borosilicate résistant à la chaleur · PP-plastique · Noir

# Grace

100% recyclebares Spezialglas · Ziegenhaar

100% recyclable special glass · Goat hair

Verre spécial 100% recyclable · Brosse en poils naturels

MADE  
IN  
GERMANY



**Hohe Bruchsicherheit** kurze Transportwege und faire Produktionsbedingungen. Hergestellt in Deutschland aus einem 100% recyclebaren Spezialglas. Auch bei der Reinigungsbürste wurde auf Kunststoff verzichtet. Die Trinkhalme können zur Reinigung auch in den Geschirrspüler gegeben werden.

**Excellent safety from breaking.** Produced in Germany from 100% recyclable special glass. Excellent safety from breaking, short transport routes and fair production conditions. No plastic is used in the cleaning brush either. The drinking straws can also be cleaned in the dishwasher.

Fabriqué en Allemagne à partir d'un verre spécial 100% recyclable et très résistant. Production équitable. Brosse de nettoyage en poils naturels. Convient également pour le lavage au lave-vaisselle.

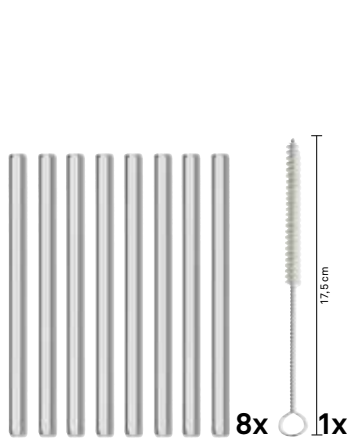
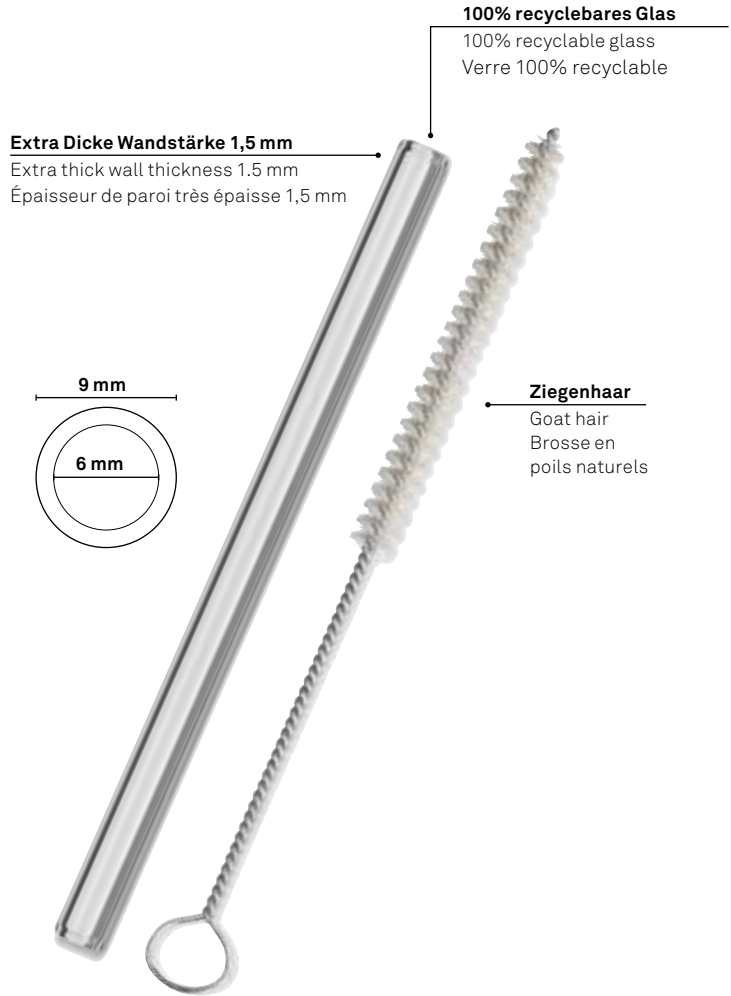

Trinkhalm 15 cm x 9 mm Ø  
Straw · Paille

1	-	24	📦
12537	4025457125379		

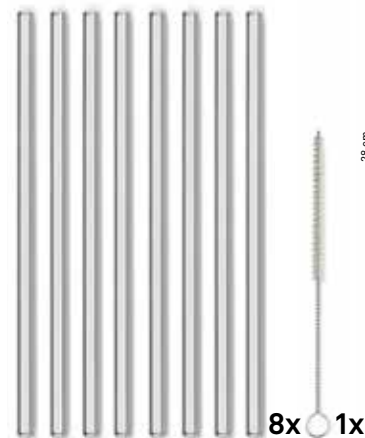

Trinkhalm 23 cm, 9 mm Ø  
Straw · Paille

1	-	27	📦
12538	4025457125386		



Display Trinkhalm 15 cm, 9 mm Ø  
Straw · Paille

-	12*	36	📦
12539	4025457125393		



Display Trinkhalm 23 cm, 9 mm Ø  
Straw · Paille

-	12*	24	📦
12544	4025457125447		



# Vision

Edelstahl 18/10  
Stainless steel 18/10  
Inox 18/10



**Butterdose Vision**  
Butter dish · Beurrier

1	6	60	📦
<b>19243</b>	4025457192432		



**Eierschneider Vision**  
Egg slicer · Trancheur à œuf

1	12	72	📦
<b>19092</b>	4025457190926		



**Eierbecher-Set Vision**  
Egg cups · Coquetiers

1	12	48	📦
<b>19246</b>	4025457192463		



**Zitronenpresse Vision**  
Lemon squeezer · Presse-citron

1	-	36	📦
<b>19200</b>	4025457192005		

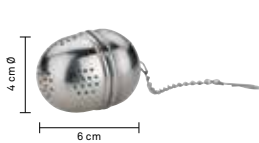

**Tee Ei Vision 4 cm Ø**  
Tea egg · Boule à thé

1	12	144	📦
<b>15314</b>	4025457153143		



**Butterdose Baldo**  
Butter dish · Beurrier

1	-	24	📦
<b>11466</b>	4025457114663		
MS-Kunststoff MS plastic · MS-plastique			



**Eierbecher-Set Globul**  
Egg cups · Set coquetiers

1	-	12	📦
<b>17580</b>	4025457175800		
Metall verchromt Metal chromed · Métal chromé			

# Maila

Keramik matt · Gummibaumholz  
 Ceramic matt · Rubber tree wood  
 Céramique mat · Bois d'yucca



<b>Utensilienhalter</b>			
Kitchen gadget · Porte ustensiles			
1	4	16	📦
12564	4025457125645		



<b>Vorratsdose</b>			
Storage jar · Bocal hermétique			
-	4*	12	0,75 L
12480	4025457124808		



<b>Vorratsdose</b>			
Storage jar · Bocal hermétique			
-	4*	12	1,0 L
12481	4025457124815		

Der Silikonring im Deckel sorgt dafür, dass Zutaten länger ihr Aroma behalten.

The silicone ring in the lid ensure that ingredients retain their flavour for longer.

Couvercle muni d'un joint en silicone qui assure l'étanchéité pour la conservation maximale des arômes.



NEW



**Salz-/ Pfefferstreuer 2-er Set**  
Salt / pepper shaker · Salière et poivrière

1	-	48	📦
<b>12484</b>	4025457124846		



NEW

**Milchkännchen 170 ml**  
Milk jug · Pot à lait

1	-	24	📦
<b>12561</b>	4025457125614		



NEW

**Zuckerdose**  
Sugar bowl · Le secrier

1	-	24	📦
<b>12562</b>	4025457125621		



**Butterdose**  
Butter dish · Beurrier

1	-	16	📦
<b>12569</b>	4025457125690		



**Servier- und Auflaufform**  
Casserole dish · Plat à four

1	2	8	📦
<b>12482</b>	4025457124822		



**Servier- und Auflaufform**  
Casserole dish · Plat à four

1	2	8	📦
<b>12483</b>	4025457124839		



**Schälchen**  
Bowl · Coupelle

1	4	36
<b>12485</b>	4025457124853	



**Schüssel**  
Bowl · Coupelle

1	2	18
<b>12486</b>	4025457124860	



**Schüssel**  
Bowl · Coupelle

1	-	8
<b>12487</b>	4025457124877	



# Marlo

Metall  
Metal  
Métal



**Fruchtkorb Marlo**  
Fruit basket · Corbeille à fruits

1	-	4
<b>12510</b>		4025457125102
Schwarz · Black · Noir		

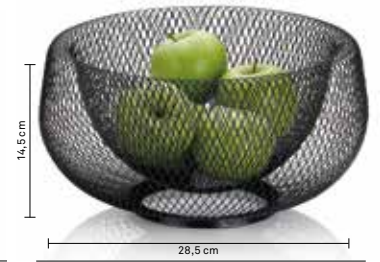

**Fruchtkorb Marlo**  
Fruit basket · Corbeille à fruits

1	-	4
<b>12511</b>		4025457125119
Schwarz · Black · Noir		

# Prato

Edelstahl 18/10  
Stainless steel 18/10  
Inox 18/10



**Fruchtkorb**  
Fruit basket · Corbeille à fruits

1	-	8	📦
<b>11498</b>		4025457114984	

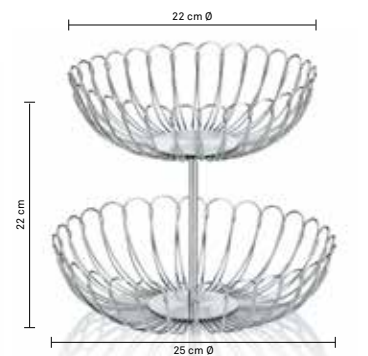

**Etagere**  
Baskets · Etagère à fruits

1	-	8	📦
<b>11497</b>		4025457114977	

## Jori / Owia

Edelstahl 18/10  
Stainless steel 18/10  
Inox 18/10



Durch die spezielle Form der Verarbeitung, einer Elektropolitur, bildet sich eine besonders glatte und sanfte Oberfläche der Drähte. Die hochwertige Art der Verarbeitung fällt sofort ins Auge.

A special manufacturing finish, electropolishing, forms a very smooth and gentle surface on the wires. You cannot fail to notice the high quality of workmanship.

Un traitement spécial, l'électropolissage, forme une surface particulièrement lisse et douce sur les fils d'inox pour une finition parfaite. Le design original attire immédiatement le regard.

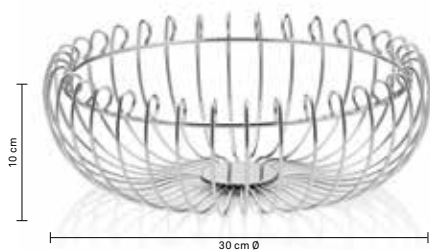

Fruchtkorb Jori

Fruit basket · Corbeille à fruits

1 - 5

12541 4025457125416

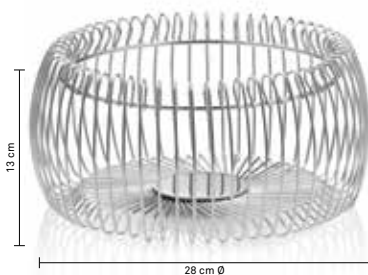

Fruchtkorb Owia

Fruit basket · Corbeille à fruits

1 - 6

12542 4025457125423

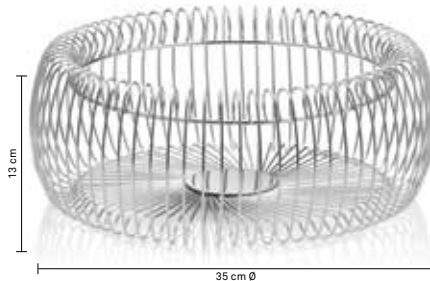

Fruchtkorb Owia

Fruit basket · Corbeille à fruits

1 - 4

12543 4025457125430



Stoffeinsatz waschbar  
Washable fabric insert  
Insert en tissu lavable



Brotkorb

Bread basket · Corbeille à pain

1 - 6

12509 4025457125096

## Miri

Metall verchromt · 100 % Baumwolle  
Metal chromed · 100 % cotton  
Métal chromé · 100 % cotton

**NEW**

# Fino

Keramik matt · Edelstahl 18/10  
 Ceramic matt · Stainless steel 18/10  
 Céramique mat · Inox 18/10

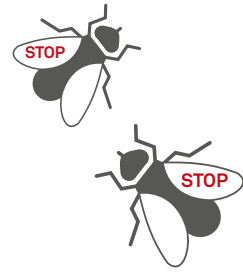

<b>Fruchtfliegenfalle</b>	
Fruit fly trap · Piège à moucheron	
1	- 24
<b>11900</b>	4025457119002
Weiß · White · Blanc	



<b>Fruchtfliegenfalle</b>	
Fruit fly trap · Piège à moucheron	
1	- 24
<b>11901</b>	4025457119019
Hellgrau · Light grey · Gris clair	

# Cara

Edelstahl 18/10  
 Stainless steel 18/10  
 Inox 18/10

Feinmaschig –  
 innen mit Draht verstärkt.  
 Extra small holes –  
 Inside reinforced with wire.  
 Grillage de protection extra fin –  
 Intérieur renforcé par du fil de fer.



<b>Abdeckhaube Cara</b>	
Cover · Couvre plat	
1	- 24
<b>11475</b>	4025457114755



<b>Abdeckhaube Cara</b>	
Cover · Couvre plat	
1	- 24
<b>11444</b>	4025457114441

# Como

Metall farbig beschichtet  
 Metal colour coated  
 Métal revêtement couleur



**NEW**



<b>Abdeckhaube Como</b>	
Cover · Couvre plat	
1	- 24
<b>11447</b>	4025457114472
Grau · Grey · Gris	



<b>Abdeckhaube Como</b>	
Cover · Couvre plat	
1	- 24
<b>11401</b>	4025457114014
Minzgrün · Mint green · Vert menthe	

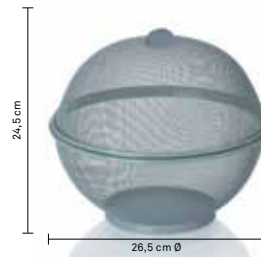

<b>Fruchtkorb Como</b>	
Fruit basket · Corbeille à fruits	
1	- 12
<b>11449</b>	4025457114496
Grau · Grey · Gris	



<b>Fruchtkorb Como</b>	
Fruit basket · Corbeille à fruits	
1	- 12
<b>11402</b>	4025457114021
Minzgrün · Mint green · Vert menthe	

**NEW**



## Caro & Globul

Metall verchromt  
Metal chromed  
Métal chromé



**Küchenrollenhalter Caro**  
Kitchen roll holder · Support à essuie-tout

1	12	24	📦
<b>12238</b>	4025457122385		



**Küchenrollenhalter Globul**  
Kitchen roll holder · Support à essuie-tout

1	12	24	📦
<b>17582</b>	4025457175824		



**Küchenrollenhalter Rollo**  
Kitchen roll holder · Support à essuie-tout

1	-	12	📦
<b>16920</b>	4025457169205		
Edelstahl · Stainless steel · Inox			
Matt · Matt · Mat			



**Küchenrollenhalter Katana**  
Kitchen roll holder · Support à essuie-tout

1	-	12	📦
<b>11873</b>	4025457118739		
Bambus · Bamboo · Bambou			

## Rollo / Katana

Edelstahl / Bambus  
Stainless steel / Bamboo  
Inox / Bambou



**Küchenrollenhalter**  
Kitchen roll holder · Support à essuie-tout

1	-	12	📦
<b>11201</b>	4025457112010		
Weiß · White · Blanc			



**Küchenrollenhalter**  
Kitchen roll holder · Support à essuie-tout

1	-	12	📦
<b>11203</b>	4025457112034		
Hellgrau · Light grey · Gris clair			



**Küchenrollenhalter**  
Kitchen roll holder · Support à essuie-tout

1	-	12	📦
<b>11200</b>	4025457112003		
Schwarz · Black · Noir			

## Stella

Metall farbig beschichtet · Edelstahl  
Colour-coated metal · Stainless steel  
Métal revêtement couleur · Inox

# Loop

Metall verchromt  
Metal verchromt  
Métal chromé

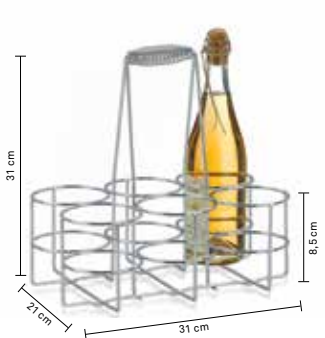

**Flaschenträger Loop**

Bottle holder · Porte-bouteilles

1 - 10

49880 4025457498800

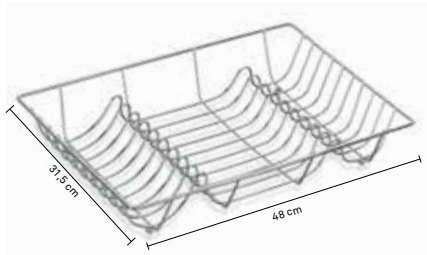

**Geschirrabtropfkorb Loop**

Draining rack · Egouttoir à vaisselle

1 - 12

49553 4025457495533

**Drahtetagere Loop**

Hanging baskets · Etagère à paniers

1 - 12

49552 4025457495526

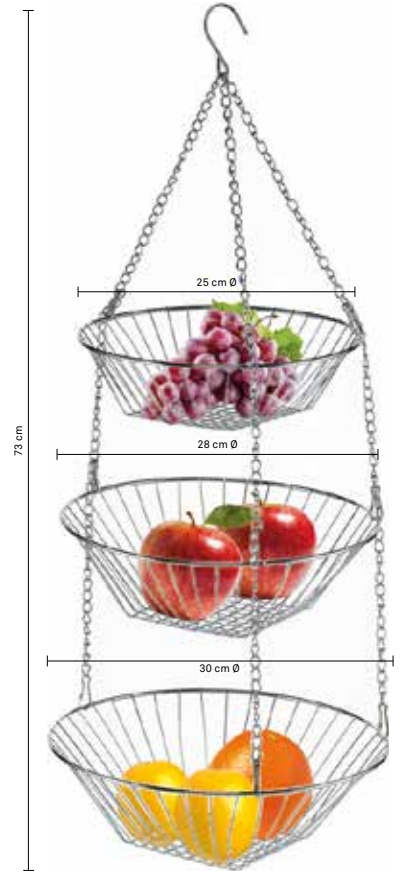

# Untersetzer

Für Teekanne, Pfanne und Co.  
For teapots, pans and Co.  
Pour théières, casseroles et Co.

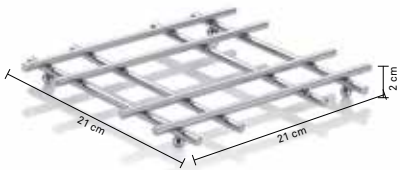

**Untersetzer Caro**

Table protector · Dessous de plat

1 - 12

12235 4025457122354

Metall verchromt  
Metal chromed · Métal chromé

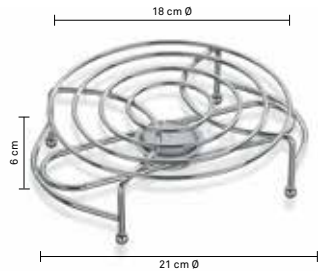

**Stövchen Globul**

Teapot warmer · Chauffe-plat

1 - 24

17600 4025457176005

Metall verchromt  
Metal chromed · Métal chromé

Ohne Teelicht · Without tealight  
Sans bougie chauffe-plat

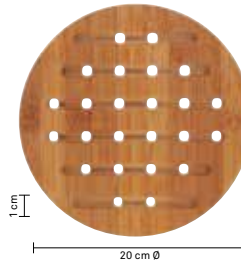

**Untersetzer Kian**

Trivet · Dessous de plat

1 - 40

11798 4025457117985

Bambus · Bamboo · Bambou

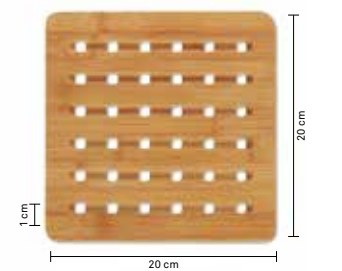

**Untersetzer Kian**

Trivet · Dessous de plat

1 - 40

11797 4025457117978

Bambus · Bamboo · Bambou

Ordnen und Aufbewahren · Organize and store · Rangement et conservation

# FRISCHEKICK





## Bevorratung aus Borosilikatglas

Borosilikatglas ist in Verbindung mit Lebensmitteln erste Wahl. Optisch lichtdurchlässiger als anderes Glas und trotzdem sehr robust. Es nimmt keinerlei Geruch, Geschmack oder Verfärbung an. Die Deckel dieser Serien sind mit einem Silikonring ausgestattet, der für eine aromadichte Aufbewahrung sorgt.

Borosilicate glass is the material of choice for use with food. Visually more transparent than other glass, yet extremely hard-wearing. It does not absorb odours, flavours or colouring. The lids on this range feature a silicone ring to retain flavours during storage.

Le verre borosilicate est le premier choix en matière de contact alimentaire, optiquement plus translucide que les autres verres et pourtant très robuste. Il n'absorbe ni les odeurs, ni les goûts. Tous les couvercles sont munis d'un bord en silicone qui assure l'étanchéité pour la conservation maximale des arômes.

## Amelie

Borosilikatglas · Deckel aus Buche  
Borosilicate glass · Beechwood lid  
Verre borosilicate · Couvercle en hêtre



Vorratsdose 10 cm Ø

Storage jar · Bocal hermétique

- 4\* 12 0,8 L

**11955** 4025457119552

- 4\* 12 1,0 L

**11956** 4025457119569

Vorratsdose 10 cm Ø

Storage jar · Bocal hermétique

- 4\* 12 1,5 L

**11957** 4025457119576

- 4\* 12 1,9 L

**11958** 4025457119583

## Baker

Borosilikatglas · Deckel aus Edelstahl 18/10  
Borosilicate glass · Stainless steel 18/10 lid  
Verre borosilicate · Couvercle en inox 18/10



Vorratsdose 7,5 cm Ø

Storage jar · Bocal hermétique

- 6\* 24 0,25 L

**10765** 4025457107658

- 6\* 24 0,35 L

**10766** 4025457107665

Vorratsdose 9,5 cm Ø

Storage jar · Bocal hermétique

- 4\* 24 0,6 L

**10767** 4025457107672

- 4\* 16 1,1 L

**10768** 4025457107689

- 4\* 16 1,3 L

**10769** 4025457107696

## Nea

Borosilikatglas · Deckel aus Buche  
Borosilicate glass · Beechwood lid  
Verre borosilicate · Couvercle en hêtre

NEW

### Getöntes Glas für längere Aroma- und Farbfrische



#### Vorratsdose 10 x 10 cm

Storage jar · Bocal hermétique

- 4\* 12 0,75 L

10776 4025457107764

- 4\* 12 1,1 L

10777 4025457107771

#### Vorratsdose 10 x 10 cm

Storage jar · Bocal hermétique

- 4\* 12 1,5 L

10778 4025457107788

- 4\* 12 2,0 L

10779 4025457107795



Getöntes Glas ist nicht nur optisch attraktiv, es schützt zudem den Inhalt vor Sonnenlicht. Aroma und Farbe bleiben länger erhalten.

The tinted glass is visually attractive and also protects the contents from sunlight. Flavours and colour are preserved for longer.

Le verre fumé, en plus d'être très élégant, protège également le contenu de la lumière du soleil. L'arôme et la couleur des aliments sont ainsi préservés plus longtemps.

## Arik

Borosilikatglas · Deckel aus ABS/PP-Kunststoff  
Borosilicate glass · Lid: ABS/PP plastic  
Verre de borosilicate · Couvercle: ABS/PP-plastique

### Mit Aroma-Klick



Mit einem einfachen Klick lässt sich die Vorratsdose Arik luftdicht und aromadicht verschließen. Beim Schließen des Hebels wird der Silikonring an den Rand des Glases gedrückt. Der Deckel sitzt nun sehr fest auf der Vorratsdose auf. Durch die Vertiefung im Deckel lassen sich die Gläser zur Aufbewahrung stapeln.

A single click ensures an airtight seal, preventing the flavour of the food from escaping. When the lever is closed, the silicone ring is pressed against the edge of the glass. The lid now sits tightly on the storage jar. The indentation on the lid means that the jars can be stacked for storage.

D'un simple clic, la boîte de stockage Arik peut être scellée de manière étanche à l'air, à l'eau et aux arômes. Stockage facile et empilable. La profondeur du couvercle permet un empilage facile.



#### Vorratsdose 10,5 cm Ø

Storage jar · Bocal hermétique

- 4\* 12 0,6 L

12104 4025457121043

- 4\* 12 0,9 L

12105 4025457121050

- 4\* 12 1,2 L

12106 4025457121067

Weiß · White · Blanc

#### Vorratsdose 10,5 cm Ø

Storage jar · Bocal hermétique

- 4\* 12 0,6 L

12107 4025457121074

- 4\* 12 0,9 L

12108 4025457121081

- 4\* 12 1,2 L

12109 4025457121098

Hellgrau · Light grey · Gris clair

## Bera

Glas · Deckel Edelstahl 18/10  
 Glass · Stainless steel 18/10 lid  
 Verre · Couvercle en inox 18/10



Vorratsdose 11 cm Ø			
Storage jar · Bocal hermétique			
-	4*	12	0,8 L
<b>17870</b>		4025457178702	
-	4*	17	1,2 L
<b>17869</b>		4025457178696	

Vorratsdose 11 cm Ø			
Storage jar · Bocal hermétique			
-	4*	22	1,7 L
<b>17868</b>		4025457178689	
-	4*	27	2,1 L
<b>17867</b>		4025457178672	

## Diana

Glas · Deckel Edelstahl 18/10  
 Glass · Stainless steel 18/10 lid  
 Verre · Couvercle en inox 18/10

**NEW**



Vorratsdose 11 cm Ø			
Storage jar · Bocal hermétique			
-	4*	12	0,75 L
<b>11950</b>		4025457119507	
-	4*	17	1,2 L
<b>11951</b>		4025457119514	

Vorratsdose 11 cm Ø			
Storage jar · Bocal hermétique			
-	4*	22	1,6 L
<b>11952</b>		4025457119521	
-	4*	27	2,0 L
<b>11953</b>		4025457119538	



# Isa

Glas · Deckel Edelstahl 18/10  
 Glass · Stainless steel 18/10 lid  
 Verre · Couvercle en inox 18/10



<b>Vorratsdose 11 x 11 cm</b>			
Storage jar · Bocal hermétique			
-	4*	12	0,75 L
<b>10770</b>	4025457107702		
-	4*	12	1,0 L
<b>10771</b>	4025457107719		

<b>Vorratsdose 11 x 11 cm</b>			
Storage jar · Bocal hermétique			
-	4*	12	1,5 L
<b>10772</b>	4025457107726		-
	4*	12	2,0 L
<b>10773</b>	4025457107733		



# Rosa & Thea

Glas  
 Glass  
 Verre



4x



Edelstahl 18/10  
 Stainless steel · Inox

3x

<b>Vorratsdosen-Set Rosa 6 x 8 cm</b>			
Storage jars set			
Set bocal hermétique			
1	-	12	0,2 L
<b>11920</b>	4025457119200		
Deckel aus Kunststoff Lid: Plastic · Couvercle: Plastique			

<b>Vorratsdosen-Set Thea 7 x 7 cm</b>			
Storage jars set			
Set bocal hermétique			
1	-	16	0,25 L
<b>11921</b>	4025457119217		



# Jule

Aus hochwertigem und robustem MS-Kunststoff  
 High quality and sturdy MS plastic  
 En MS-résine de haute qualité et robuste



Platzsparendes Aufbewahren, dank stapelbarem Deckelsystem.  
 Optimum storage, thanks to stacking lid system.  
 Rangement facilité par système d'empilage.



Vorratsdose 10,5 x 10,5 cm			
Storage jar · Bocal hermétique			
-	4*	48	0,5 L
<b>12050</b>		4025457120503	
-	4*	32	0,8 L
<b>12051</b>		4025457120510	

Vorratsdose 10,5 x 10,5 cm			
Storage jar · Bocal hermétique			
-	4*	24	1,2 L
<b>12052</b>		4025457120527	
-	4*	16	1,9 L
<b>12053</b>		4025457120534	

# Salena

Keramik mit Deckel aus Bambus  
 Ceramic with bamboo lid  
 Céramique avec couvercle en bambou



Luftlöcher sorgen für optimale Luftzirkulation.  
 Ventilation for lasting freshness.  
 Une meilleure aération afin d'éviter les moisissures.



**Brotkasten**  
 Bread bin · Boîte à pain

1 - 2   
**12064** 4025457120640



**Knoblauchtopf**  
 Garlic pot · Pot d'ail

1 - 6   
**12066** 4025457120664



**Zwiebeltopf**  
 Onion pot · Pot d'oignon

1 - 4   
**12067** 4025457120671



**Kartoffeltopf**  
 Potato pot · Pot à pommes de terre

1 - 4   
**12068** 4025457120688



# Namur / Katana

PS-Kunststoff · Bambus  
 PS plastic · Bamboo  
 PS-plastique · Bambou

**Luftlöcher im Deckel**  
 Air holes on the Lid  
 Couvercle avec trous d'aération



**Brotkasten Namur**  
 Bread bin · Boîte à pain

- - 2\*

**12060** 4025457120602

Weiß · White · Blanc



**Beige** · Beige · Beige

- - 2\*

**12061** 4025457120619



**Opalgrau** · Opal grey · Gris opal

- - 2\*

**12062** 4025457120626



**Dunkelgrau** · Dark grey · Gris foncé

- - 2\*

**12063** 4025457120633

Einfaches Öffnen



**Brotkasten Katana**  
 Bread bin · Boîte à pain

1 - 4

**11841** 4025457118418

## Friscolino / Frisco

Metall glänzend mit farbiger Beschichtung  
Metal bright with coloured coating  
Métal brillant avec revêtement coloré



### Luftlöcher im Deckel

Air holes on the Lid  
Revêtement extérieur émaillé



**Brotkasten Friscolino**  
Bread bin · Boîte à pain

1 - 4

**11176** 4025457111761

Weiß · White · Blanc



**Brotkasten Friscolino**  
Bread bin · Boîte à pain

1 - 4

**11177** 4025457111778

Hellgrau · Light grey · Gris clair



**Brotkasten Frisco**  
Bread bin · Boîte à pain

1 - 4

**11165** 4025457111655

Weiß · White · Blanc



**Brotkasten Frisco**  
Bread bin · Boîte à pain

1 - 4

**11167** 4025457111679

Hellgrau · Light grey · Gris clair



**Brotkasten Frisco**  
Bread bin · Boîte à pain

1 - 4

**11168** 4025457111686

Beige · Beige · Beige

Einfach auf  
gewünschtes Maß ziehen



**Besteckkasten Kalma**  
Cutlery box · Range couverts

1 - 8

**12011** 4025457120114



**Besteckkasten Kalma**  
Cutlery box · Range couverts

1 - 8

**12012** 4025457120121

Ausziehbar · Expendable · Extensible



**Besteckkasten Kalma**  
Cutlery box · Range couverts

1 - 6

**12013** 4025457120138

Ausziehbar · Expendable · Extensible

## Kalma

Bambus  
Bamboo  
Bambou

## Soletta

EVA-Kunststoff · Transparent mit Noppen  
 ECA platic · Transparent  
 EVA-plastique · Transparent



### Schubladenmatte Soletta

Drawer mat · Tapis de tiroir

- - 36\*  

**11390** 4025457113901

150 x 50 cm

**Gute Antirutsch-Eigenschaft.**  
**Einfaches Zuschneiden.**  
**Geräuschdämmend.**  
**Leicht zu reinigen.**  
**Feucht abwischbar.**

Good non-slip properties.  
 Ease of cutting.  
 Sound-insulating.  
 Easy to clean – wipe when damp.

Bonne propriété anti dérapante.  
 Découpage facile.  
 Atténue les bruits.  
 Nettoyage facile.  
 Nettoyable à l'aide d'un chiffon humide

### 36 Stück im Verkaufsdisplay.

36 pieces  
 in the customer attractive display.  
 A partir de 36 pièces.  
 dans un présentoir motivant.

L31 / T31 / H51

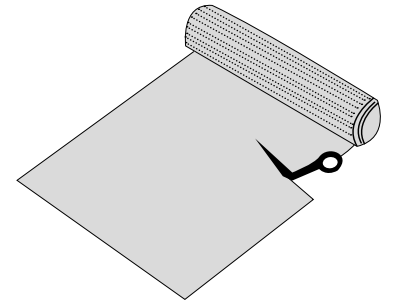



## Linnea

PVC · Grau  
 PVC · Grey  
 PVC · Gris



### Antirutschmatte Linnea

Non-slip mat · Tapis antidérapant

- - 25\*  

**11389** 4025457113895

150 x 50 cm

**Extrem rutschhemmend.**  
**Dünn und sehr anschmiegsam.**  
**Passt perfekt in Ecken und Kanten.**  
**Einfaches Zuschneiden.**  
**Geräuschdämmend.**  
**Leicht zu reinigen.**  
**Feucht abwischbar.**

Extremely slip-resistant.  
 Thin and extremely soft and smooth.  
 Fits corners and edges perfectly.  
 Simple to cut.  
 Noise-insulating.  
 Easy-clean - wipeable.

Extrêmement antidérapant.  
 Fin et extrêmement souple.  
 S'adapte parfaitement aux bords et  
 aux recoins.  
 Facile à découper.  
 Insonorisant.  
 Facile à nettoyer - essuyable.

### 25 Stück im Verkaufsdisplay.

25 pieces in the customer  
 attractive display.  
 A partir de 25 pièces  
 dans un présentoir motivant.

L30,5 / T19 / H26,5





Küchentextil · Kitchen textiles · Textiles de cuisine

# FARBENFROH

Unsere Textilien sind aus 100 % Baumwolle gefertigt, saugfähig und fusselarm. Besonderen Wert legen wir auf die Ausführung im Detail. Die Kanten sind hochwertig vernäht und eine kurze Seite ist mit einer praktischen Aufhängeschleufe versehen. Die Schürze kann durch Druckknöpfe variabel eingestellt werden.

Our textiles are made of 100 % cotton, absorbent and with minimum lint. We attach particular value to details. The corners feature quality stitching and one short side boasts a handy hanging loop. Snap fasteners allow the apron to be adjusted.

Tous nos textiles sont garantis 100 % Coton, absorbant et sans bouloches. Nous sommes particulièrement attentifs aux détails lors de la fabrication. Les coutures sont proposées en coins capuchon et un crochet pratique pour faciliter la suspension. Deux boutons pressions permettent de régler la hauteur du tablier.

# Tia

100 % Baumwolle, gewebt · Füllung Polyester  
 100 % Cotton, woven · Filling polyester  
 100 % Coton, tissé · Rembourrage polyester

1	<b>Schürze</b> · Apron · Tablier				
	-/2*/48		80 x 67 cm		
2.	<b>Topfhandschuh</b> · Oven glove · Gant				
	-/4*/160 190 gsm		31 x 18 cm		€€
3.	<b>Topflappen</b> · Oven cloth · Manique				
	-/4*/180 190 gsm		20 x 20 cm		€€
4.	<b>Geschirrtuch</b> · Dish towel · Torchon de cuisine				
	-/4*/144 190 gsm		70 x 50 cm		
5.	<b>Geschirrtuch Waffel</b> · Dish towel · Torchon de cuisine				
	-/4*/144 190 gsm		70 x 50 cm		
6.	<b>Küchenhandtuch</b> · Kitchen towel · Serviette de cuisine				
	1/-/18 450 gsm		50 x 50 cm		<b>2x</b>



Lichtgrau · Light grey · Gris clair

1.a. 12719 4025457127199

Graphitgrau · Graphit grey · Gris graphite

1.b. 12720 4025457127205

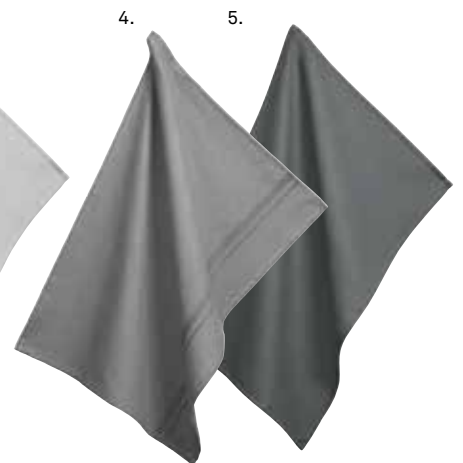
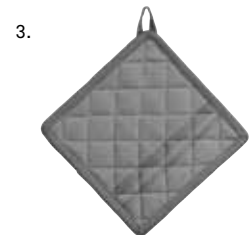
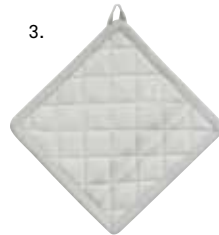

Lichtgrau · Light grey · Gris clair

2. 12700 4025457127007

3. 12701 4025457127014

4. 12702 4025457127021

5. 12703 4025457127038

6. 12727 4025457127274

Graphitgrau · Graphit grey · Gris graphite

2. 12705 4025457127052

3. 12706 4025457127069

4. 12707 4025457127076

5. 12708 4025457127083

6. 12728 4025457127281

# Tia

100 % Baumwolle  
100 % Cotton  
100 % Coton



## Sommerblau · Summer blue · Bleu été

- 2. 12715 4025457127151
- 3. 12716 4025457127168
- 4. 12717 4025457127175
- 5. 12718 4025457127182
- 6. 12726 4025457127267

## Minzgrün · Mint green · Vert Menthe

- 2. 12710 4025457127106
- 3. 12711 4025457127113
- 4. 12712 4025457127120
- 5. 12713 4025457127137
- 6. 12725 4025457127250







## Flieder · Mac · Lilas

- 2. 12735 4025457127359
- 3. 12736 4025457127366
- 4. 12737 4025457127373
- 5. 12738 4025457127380
- 6. 12729 4025457127298



# Tabea

100 % Baumwolle, gewebt  
 100 % Cotton, woven  
 100 % Coton, tissé

<b>Schürze</b> · Apron · Tablier			
-/2*/48		80 x 67 cm	
<b>Topfhandschuh</b> · Oven glove · Gant			
-/4*/160		28 x 18 cm	€€
<b>Topflappen</b> · Oven cloth · Manique			
-/4*/180		20 x 20 cm	€€
<b>Geschirrtuch</b> · Dish towel · Torchon de cuisine			
-/4*/144	190 gsm 	70 x 50 cm	

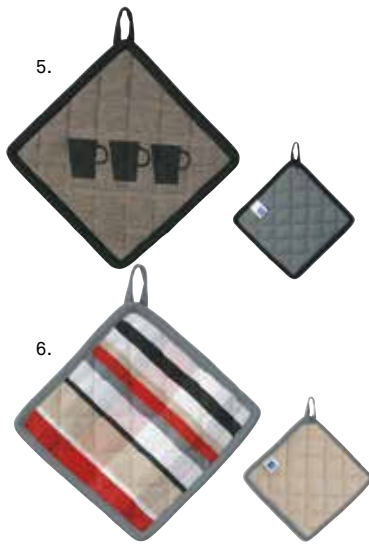

3. 11737 4025457117374  
 4. 11739 4025457117398

5. 11738 4025457117381  
 6. 11740 4025457117404

1. 11741 4025457117411  
 2. 11742 4025457117428



7. 11730 4025457117305  
 8. 11731 4025457117312

9. 11732 4025457117329  
 10. 11733 4025457117336

11. 11734 4025457117343  
 12. 11736 4025457117367

# Carla

100 % Baumwolle, gewebt  
100 % Cotton, woven  
100 % Coton, tissé



1. 12274 4025457122743  
2. 12275 4025457122750

<b>Schürze</b> · Apron · Tablier			
-/2*/48		80 x 67 cm	
<b>Topfhandschuh</b> · Oven glove · Gant			
-/4*/160		28 x 18 cm	CE
<b>Topflappen</b> · Oven cloth · Manique			
-/4*/180		20 x 20 cm	CE
<b>Geschirrtuch</b> · Dish towel · Torchon de cuisine			
-/4*/144	190 gsm		



3. 12272 4025457122729  
4. 12273 4025457122736

5. 12270 4025457122705  
6. 12271 4025457122712



7. 12276 4025457122767  
8. 12277 4025457122774

9. 12278 4025457122781  
10. 12279 4025457122798

11. 12280 4025457122804  
12. 12281 4025457122811

# Henrik

100 % Baumwolle, gewebt  
 100 % Cotton, woven  
 100 % Coton, tissé



Passendes Käsefondue sowie Zusatzartikel auf Seite 130

Matching fondue and additional items on page 130

Fondue assortie et autres articles à la page 130

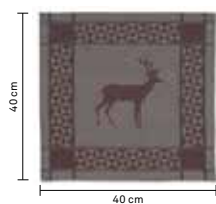

**Serviette Hirsch**  
 Napkin · Serviette de table

- 6\* 144

**12268** 4025457122682

195 gsm



**Tisch-Set Hirsch**  
 Table set · Set de table

- 6\* 144

**12269** 4025457122699

195 gsm

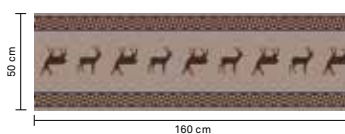

**Tischläufer Hirsch**  
 Table runner · Chemin de table

- 3 48

**12267** 4025457122675

195 gsm

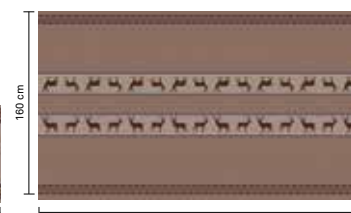

**Tischdecke Hirsch**  
 Tablecloth · Nappe

1 - 12

**12266** 4025457122668

195 gsm



<b>Schürze</b> · Apron · Tablier			
-/2*/48		80 x 67 cm	
<b>Topfhandschuh</b> · Oven glove · Gant			
-/4*/160		28 x 18 cm	☐☐
<b>Topflappen</b> · Oven cloth · Manique			
-/4*/180		20 x 20 cm	☐☐
<b>Geschirrtuch</b> · Dish towel · Torchon de cuisine			
-/4*/144	190 gsm		70 x 50 cm



1.



3.



2.



4.

1. 12288 4025457122880  
2. 12285 4025457122859

3. 12287 4025457122873  
4. 12286 4025457122866

5. 12289 4025457122897  
6. 12290 4025457122903



5.

6.



7.

8.

9.

10.

11.

12.

7. 12292 4025457122927  
8. 12293 4025457122934

9. 12294 4025457122941  
10. 12295 4025457122958

11. 12296 4025457122965  
12. 12298 4025457122989



Halbschürze Dreieck  
Waist apron · Tablier

- 6\* 48

12291 4025457122910

## Rapida / Amparo

Abtropfmatte & Pfannenschutz  
Draining mat & Pan protection set  
Tapis d'évier & Set protection poêle



31/35/39 cm Ø

3x

### Pfannenschutz-Set Amparo

Pan protection set · Set protection poêle

- 12\* 24

3-teilig · 3 pieces · 3 pièces

Filz · Felt · Feutre 3 mm

12327 4025457123276

1x Dunkelgrau · Sommerblau · Hellgrau  
1x Dark grey · Summer blue · Light grey  
1x Gris foncé · Été bleu · Gris clair

12328 4025457123283

1x Dunkelgrau · Minzgrün · Hellgrau  
1x Dark grey · Mint green · Light grey  
1x Gris foncé · Vert menthe · Gris clair

11652 4025457116520

2x Schwarz · 1x Grau

2x Black · 1x Grey · 2x Noir · 1x Gris



Hält 4 x soviel Wasser wie das eigene Volumen. Verhindert Kalkränder und Wasserflecken. Schnell trocknend. Luftzirkulation, wasserabsorbierende Schicht. Bei 30° waschbar. Fleckenresistent.  
Holds four times its own volume of water. Quick-drying. Air circulation, water-absorbing layer 30° Washable - Stain-resistant.  
Retient 4x son volume en eau. Sèche rapidement - Circulation d'air, revêtement absorbant d'eau 30° lavable - Résistant aux tâches.

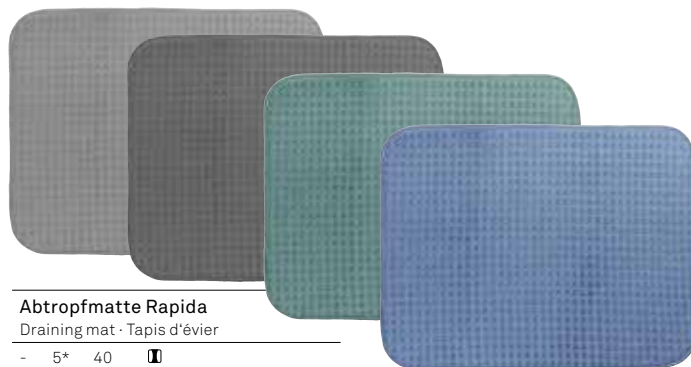

### Abtropfmatte Rapida

Draining mat · Tapis d'évier

- 5\* 40

100 % Polyester

11642 4025457116421

Grau · Grey · Gris

11707 4025457117077

Graphitgrau · Graphit grey · Gris graphite

11708 4025457117084

Minzgrün · Mint green · Menthe vert

11709 4025457117091

Sommerblau · Summer blue · Bleu été

50 x 38 cm



## Pasado

100 % Baumwolle 200 gsm  
100 % Cotton 200 gsm  
100 % Coton 200 gsm



3x

### Geschirrtücher

Dish towels · Torchons de cuisine

- 12\* 48 65 x 45 cm

**15964** 4025457159640

1x Blau 2x Karo  
1x Blue 2x Checked  
1x Bleu 2x Carreau



3x

### Geschirrtücher

Dish towels · Torchons de cuisine

- 12\* 48 65 x 45 cm

**15961** 4025457159619

1x Grau 1x Karo 1x Streifen  
1x Grey 1x Checked 1x Stripe  
1x Gris 1x Carreau 1x Bande



3x

### Geschirrtücher

Dish towels · Torchons de cuisine

- 12\* 48 65 x 45 cm

**15963** 4025457159633

1x Rot 1x Karo 1x Streifen  
1x Red 1x Checked 1x Stripe  
1x Rouge 1x Carreau 1x Bande



3x

### Geschirrtücher

Dish towels · Torchons de cuisine

- 12\* 48 65 x 45 cm

**15971** 4025457159718

1x Jeansblau 2x Streifen  
1x Jeans blue 2x Stripe  
1x Jean bleu 2x Bande



3x

### Geschirrtücher

Dish towels · Torchons de cuisine

- 12\* 48 65 x 45 cm

**15970** 4025457159701

1x Rosa 1x Karo 1x Streifen  
1x Rose 1x Checked 1x Stripe  
1x Rosé ancien 1x Carreau 1x Bande



3x

### Geschirrtücher

Dish towels · Torchons de cuisine

- 12\* 48 65 x 45 cm

**15969** 4025457159695

1x Olivegrün 1x Karo 1x Streifen  
1x Olive green 1x Checked 1x Stripe  
1x Vert olive 1x Carreau 1x Bande

## Supor / Lou

Mikrofaser  
Microfibre  
Microfibre



4x

**NEW**

### Universal-Reinigungstücher Supor

Universal cleaning cloths

Microfibre universelle

- 6\* 54 35 x 35 cm

**12730** 4025457127304

80 % Polyester · Polyester · Polyester  
20 % Polyamid · Polyamide · Polyamide

300 gsm

2x Sommerblau 2x Grau  
2x Summer blue 2x Grey  
2x Bleu été 2x Gris



4x

**NEW**

### Universal-Reinigungstücher Supor

Universal cleaning cloths

Microfibre universelle

- 6\* 54 35 x 35 cm

**12731** 4025457127311

80 % Polyester · Polyester · Polyester  
20 % Polyamid · Polyamide · Polyamide

300 gsm

2x Minzgrün 2x Grau  
2x Mint green 2x Grey  
2x Vert menthe 2x Gris



8x

### Universal-Reinigungstücher Lou

Universal cleaning cloths

Microfibre universelle

- 6\* 48 30 x 30 cm

**11684** 4025457116841

100 % Polyester · Polyester · Polyester

200 gsm

2x Opalgrau · Opal grey · Gris opal  
2x Pastellblau · Pastel blue · Bleu pastel  
2x Pastellgrün · Pastel green · Vert pastel  
2x Pastelltürkis · Pastel turquoise ·  
Bleu turquoise



# Nicoletta

85 % PVC · 15 % Polyester

85 % PVC · 15 % Polyester

85 % PVC · 15 % Polyester

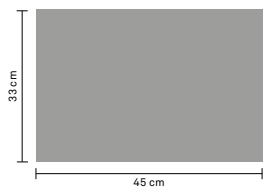

## Tisch-Set

Placemats · Set de table

- 12\* 144

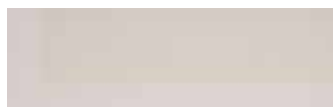

**Creme** · Cream · Crème

12035 4025457120350



**Weiß/Schwarz** · White/Black · Blanc/Noir

12037 4025457120374



**Rot** · Red · Rouge

12043 4025457120435



**Goldbraun** · Golden brown · Brun doré

12044 4025457120442



**Grün** · Green · Vert

12039 4025457120398



**Dunkelgrün** · Dark green · Vert foncé

12040 4025457120404



**Braun** · Brown · Brun

12046 4025457120466



**Anthrazit** · Anthracite · Anthracite

12045 4025457120459



**Blau** · Blue · Bleu

12041 4025457120411



**Aubergine** · Aubergine · Aubergine

12042 4025457120428

# Alia

100 % Filz · 4 mm stark  
 100 % Felt · 4 mm thick  
 100 % Feutre · 4 mm épais

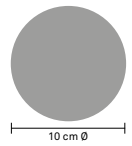
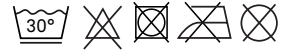

## Untersetzer

Trivet · Dessous-de-plat

- 6\* 120

4-teilig · 4 pieces · 4 pièces

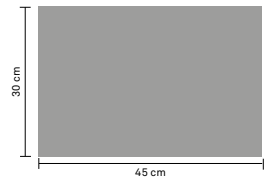

## Tisch-Set

Placemat · Set de table

- 12\* 120



Beige · Beige · Beige

12325 4025457123252



Hellgrau · Light grey · Gris clair

12321 4025457123214



Dunkelgrau · Dark grey · Gris foncé

12323 4025457123238



Braun · Brown · Brun

12320 4025457123207



Rose · Rose · Rosé

12307 4025457123078



Altrot · Dark red · Rouge ancien

12324 4025457123245



Petrol · Teal blue · Petrol

12322 4025457123221



Grün · Green · Vert

11804 4025457118043



Beige · Beige · Beige

12335 4025457123351



Hellgrau · Light grey · Gris clair

12331 4025457123313



Dunkelgrau · Dark grey · Gris foncé

12333 4025457123337



Braun · Brown · Brun

12330 4025457123306

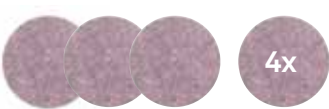

Rose · Rose · Rosé

12308 4025457123085



Altrot · Dark red · Rouge ancien

12334 4025457123344



Petrol · Teal blue · Petrol

12332 4025457123320



Grün · Green · Vert

11824 4025457118241

# Plato

70 % PVC · 30 % Polyester  
 70 % PVC · 30 % Polyester  
 70 % PVC · 30 % Polyester

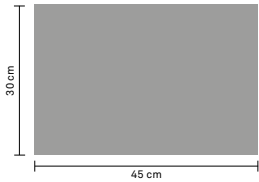

**Tisch-Set**  
 Placemats · Set de table

- 12\* 96



**Creme** · Cream · Crème

15634 4025457156342



**Weiß** · White · Blanc

15633 4025457156335



**Hellgrau** · Light grey · Gris clair

11374 4025457113741



**Grau** · Grey · Gris

15641 4025457156410

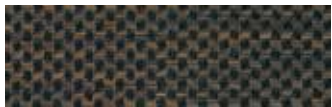

**Hellbraun/Schwarz**

Light brown/Black · Brun clair/Noir

15638 4025457156380



**Schwarz/Weiß**

Black/White · Noir/Blanc

15644 4025457156441

# Kimya

PP-Kunststoff, 2 mm stark  
 PP plastic, 2 mm thick  
 PP plastique, 2 mm épais

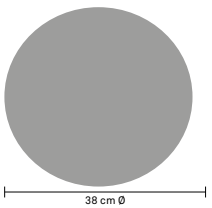

**Tisch-Set**  
 Placemats · Set de table

- 12\* 144

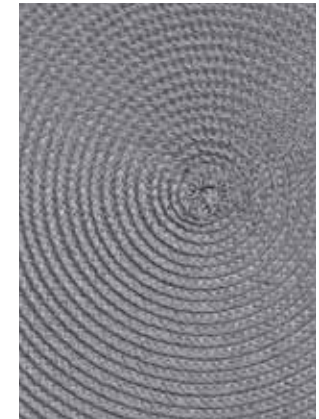

**Creme** · Cream · Crème

12339 4025457123399



**Hellgrau** · Light grey · Gris clair

12340 4025457123405



**Schwarz** · Black · Noir

12338 4025457123382



**Grau** · Grey · Gris

12337 4025457123375



# Kimara

Kunstleder, 2 mm stark  
Leatherrette, 2 mm thick  
Similicuir, 2 mm épais

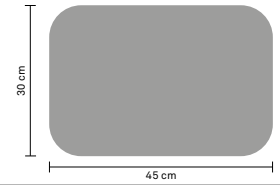

**Tisch-Set**  
Placemats · Set de table

- 12\* 48

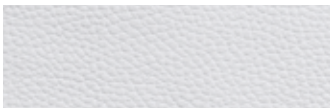

**Weiß** · White · Blanc

12095 4025457120954



**Grau** · Grey · Gris

12096 4025457120961



**Schwarz** · Black · Noir

12098 4025457120985



**Braun** · Brown · Brun

12097 4025457120978



**Rosa** · Pink · Rosé

12312 4025457123122



**Mintgrün** · Mint green · Menthe

12313 4025457123139



**Hellblau** · Light blue · Bleu clair

12311 4025457123115



**Dunkelgrau** · Dark grey · Gris foncé

12310 4025457123108

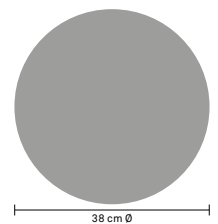

**Tisch-Set**  
Placemats · Set de table

- 12\* 72

# Kalea

Kunstleder, 2 mm stark  
Leatherrette, 2 mm thick  
Similicuir, 2 mm épais



**Braun** · Brown · Brun

12180 4025457121807

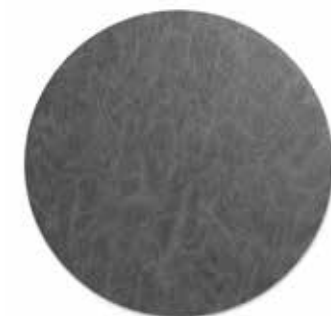

**Dunkelgrau** · Dark grey · Gris foncé

12181 4025457121814



**Hellgrau** · Light grey · Gris clair

12182 4025457121821



**Schwarz** · Black · Noir

12183 4025457121838

# Uni

100 % PVC  
100 % PVC  
100 % PVC

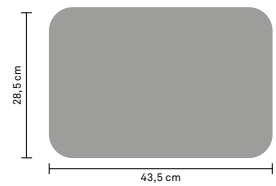

## Tisch-Set

Placemats · Set de table

- 12\* 144



**Gelb** · Yellow · Jaune

15002 4025457150029



**Rosa** · Pink · Rosé

15012 4025457150128



**Rot** · Red · Rouge

15001 4025457150012



**Altrot** · Dark red · Rouge ancien

15014 4025457150142



**Lemongrün** · Lemon green · Citron vert

15004 4025457150043



**Schwarz** · Black · Noir

15007 4025457150074



**Dunkelblau** · Dark blue · Bleu foncé

15011 4025457150111



**Pastellblau** · Pastel blue · Bleu pastel

15019 4025457150197



**Weiß** · White · Blanc

15006 4025457150067

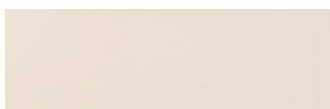

**Beige** · Beige · Beige

15008 4025457150081



**Taupe** · Taupe · Taupe

15018 4025457150180



**Grau** · Grey · Gris

15017 4025457150173

Kochen am Tisch · Cooking at the table · Cuisiner à table

# ZEITNEHMEN





# Raclette / Grillplatte / Heißer Stein

Elektrisch  
Electric  
Electrique

220 - 240 V / ~ 50 - 60 Hz



**Stufenlos regulierbar mit Kontrolllampe.**  
Infinitely adjustable temperature controller with operating light.  
Thermostat à réglage continu.



**Kippschalter EIN-AUS mit Kontrolllampe.**  
ON-OFF rocker switch, with operating light.  
Interrupteur à bascule marche arrêt, avec le témoin lumineux rouge.



## Raclette/Heißer Stein Ceneri

Raclette/ Hot stone  
Raclette/Plaque de pierre chaude **66663** 4025457666636 1 - 2

a Granit · Granite · Granit  
b Stahl antihaftbeschichtet · Non-stick coated steel · Acier antiadhésif  
c Nylon · Nylon · Nylon

Schwarz · Black · Noir

1 m: VDE-Kabel · VDE cable · Câble VDE



## Raclette/Heißer Stein Livigno

Raclette/ Hot stone  
Raclette/Plaque de pierre chaude **66661** 4025457666612 1 - 3

a Granit · Granite · Granit  
b Stahl antihaftbeschichtet · Non-stick coated steel · Acier antiadhésif  
c Nylon · Nylon · Nylon

Schwarz · Black · Noir

1 m: VDE-Kabel · VDE cable · Câble VDE



**Kippschalter EIN-AUS mit Kontrolllampe.**  
ON-OFF rocker switch, with operating light.  
Interrupteur à bascule marche arrêt, avec le témoin lumineux rouge.

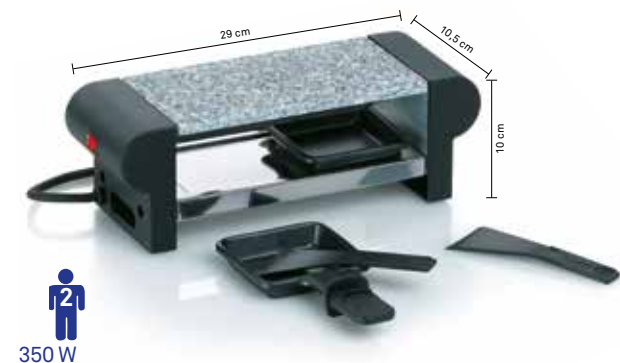

## Raclette/Grillplatte Bernina

Raclette/Grill plate  
Raclette/Plaque de grill **66490** 4025457664908 1 - 8

a Stahl antihaftbeschichtet · Non-stick coated steel · Acier antiadhésif  
b Nylon · Nylon · Nylon

Schwarz · Black · Noir

1 m: VDE-Kabel · VDE cable · Câble VDE



## Raclette/Heißer Stein Splügen

Raclette/ Hot stone  
Raclette/Plaque de pierre chaude **66493** 4025457664939 1 - 6

a Granit · Granite · Granit  
b Stahl antihaftbeschichtet · Non-stick coated steel · Acier antiadhésif  
c Nylon · Nylon · Nylon

Schwarz · Black · Noir

1 m: VDE-Kabel · VDE cable · Câble VDE



**NEW**

**Geneva**

Aluguss antihaftbeschichtet  
Cast aluminium non-stick coated  
Fonte d'aluminium antiadhésif



230 V / ~ 50-60 Hz

**Stufenlos regulierbar mit Kontrolllampe.**  
Infinitely adjustable temperature  
controller with operating light.  
Thermostat à réglage continu.



Platte  
wendbar

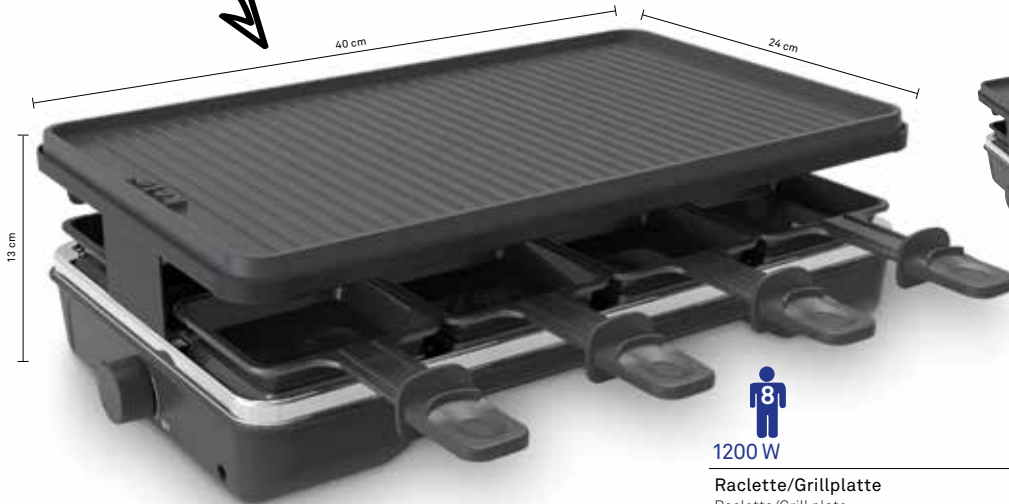

1200 W



**Raclette/Grillplatte**  
Raclette/Grill plate  
Raclette/Plaque de grill

64006 4025457640063 1 - 4

a Gusseisen · Cast iron · Fonte  
b Stahl antihaftbeschichtet · Non-stick coated steel · Acier antiadhésif  
c Holz · Wood · Bois

Schwarz · Black · Noir

**2 m EXTRA LANG:** VDE-Kabel · VDE cable · Câble VDE

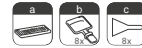

**Passend für alle kela Raclettes**

Suitable for all kela raclettes  
Convient à toutes les kela raclettes



**Raclettepfännchen Juri**  
Raclette pan · Raclette pôle

1 - 40

66496 4025457664960

Stahl antihaftbeschichtet  
Non-stick coated steel  
Acier antiadhésif

Schwarz · Black · Noir



8x

**Raclettespatel Pillon**  
Raclette spatulas · Spatules à raclette

1 24 48

66667 4025457666674

8 Stück · 8 pieces · 8 pièces

Nylon · Nylon · Nylon

Schwarz · Black · Noir



8x

**Raclettespatel Arbon**  
Raclette spatula · Spatules à raclette

1 - 140

77033 4025457770333

8 Stück · 8 pieces · 8 pièces

Buche · Beech · Hêtre



4x

**Raclette-Brettchen Baar**  
Raclette boards · Planchettes à raclette

1 - 48

77937 4025457779374

4 Stück · 4 pieces · 4 pièces

Buche · Beech · Hêtre

# Cheese o'clette

Mini-Raclette  
Mini Raclette  
Mini raclettes



**Mini-Raclette 3-teilig**  
Mini Raclette · Mini raclettes

1 - 12

**12501** 4025457125010

Akazie · Acacia · Acacia



**Mini-Raclette 3-teilig**  
Mini Raclette · Mini raclettes

1 - 12

**12500** 4025457125003

Buche · Beech · Hêtre

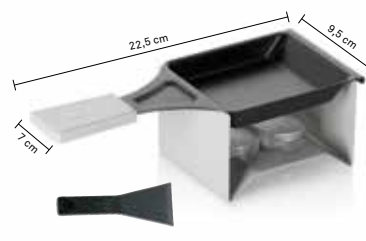

**Mini-Raclette 3-teilig**  
Mini Raclette · Mini raclettes

1 - 12

**12502** 4025457125027

Metall farbig beschichtet · Colour-coated metal · Métal revêtement couleur

Hellgrau · Light gray · Gris clair



**Mini-Raclette 3-teilig**  
Mini Raclette · Mini raclettes

1 - 12

**12503** 4025457125034

Metall farbig beschichtet · Colour-coated metal · Métal revêtement couleur

Anthrazit · Anthracite · Anthracite





NEW

# Simplon

Elektrofondue-Set Simplon  
Electric fondue-set  
Service à fondue électro



230 V / ~ 50 - 60 Hz

**Stufenlos regulierbar mit Kontrolllampe.**

Infinitely adjustable temperature controller with operating light.  
Thermostat à réglage continu.



800 W

**Elektrofondue-Set Simplon**

Electric fondue-set

Service à fondue électro

66980 4025457669804 1 - 4

**a** 0,8 mm: Stahl antihaftbeschichtet · Non-stick coated steel · Acier antiadhésif

**b** Edelstahl · Stainless steel · Inox

**c** Kunststoff · Plastic · Plastique

**d** Aluminium Heizplatte · Aluminium heating plate · Plateau chauffant en aluminium

Für ca. 1,7 L Öl oder Brühe

For approx. 1,7 l oil or stock

Pour environ 1,7 L d'huile ou de bouillon

1 m: VDE-Kabel · VDE cable · Câble VDE



# Natura

Buche  
Beech  
Hêtre



**Fonduekarussell Natura**  
Fondue caroussel · Carrousel à fondue

- - 1

**61201** 4025457612015

23-teilig · 23 pieces · 23 pièces

- a Stahl emailliert · Steel enamelled  
Acier émaillé
- b Edelstahl · Stainless steel · Inox
- c Metall verchromt  
Metal chromed · Métal chromé
- d Keramik · Ceramic · Céramique
- e Buche · Beech · Hêtre

Für ca. 1-1,2 L Öl oder Brühe  
For approx. 1-1,2 l oil or stock  
Pour environ 1-1,2 L d'huile ou de bouillon

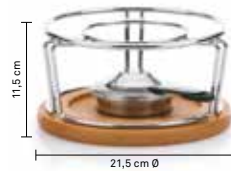

**Rechaud Natura**

Rechaud · Réchaud

1 - 12

**61000** 4025457610004

3-teilig · 3 pieces · 3 pièces

- a Edelstahl · Stainless steel · Inox
- b Metall verchromt  
Metal chromed · Métal chromé
- c Buche · Beech · Hêtre



**Käsefonduepfanne Basel 2 L**

Cheese fondue pan  
Caquelon à fondue à fromage

1 - 4

**66575** 4025457665752

Feuerfeste Keramik  
Ovenproof ceramic  
Céramique incombustible

Schwarz · Black · Noir



**Käsefondue-Set Natura 2 L**

Cheese fondue-set  
Service à fondue à fromage

1 - 2

**61306** 4025457613067

10-teilig · 10 pieces · 10 pièces

- a Feuerfeste Keramik  
Ovenproof ceramic  
Céramique incombustible
- b Edelstahl · Stainless steel · Inox
- c Metall verchromt  
Metal chromed · Métal chromé
- d Buche · Beech · Hêtre





# Armata

Akazienholz  
Acacia wood  
Bois d'acacia



**Fonduekarussell Armata**  
Fondue carrousel · Carrousel à fondue

- - 1 ☐

**66470** 4025457664700

23-teilig · 23 pieces · 23 pièces

- a 18/10 Edelstahl · Stainless steel · Inox
- b Edelstahl · Stainless steel · Inox
- c Metall verchromt  
Metal chromed · Métal chromé
- d Keramik · Ceramic · Céramique
- e Akazie · Acacia · Acacia

Für ca. 1-1,2 L Öl oder Brühe  
For approx. 1-1,2 L oil or stock  
Pour environ 1-1,2 L d'huile ou de bouillon





# Country

Akazienholz  
Acacia wood  
Bois d'acacia



## Fondue-Set

Fondue-set · Service à fondue

1 - 1

**16644** 4025457166440

11-teilig · 11 pieces · 11 pièces

**a** Gusseisen emailliert

Cast iron enameled

Fonte de fer émaillée

**b** Metall schwarz · Metal black · Métal noir

c Edelstahl · Stainless steel · Inox

**d** Akazie · Acacia · Acacia

Für ca. 0,8-1,0 L Öl oder Brühe

For approx. 0,8-1,0 l oil or stock

Pour environ 0,8-1,0 L d'huile ou de

bouillon



## Käsefondue-Set 2 L

Cheese fondue-set

Service à fondue à fromage

1 - 4

**16640** 4025457166402

10-teilig · 10 pieces · 10 pièces

**a** Feuerfeste Keramik · Ovenproof ceramic

Céramique incombustible

**b** Metall schwarz · Metal black · Métal noir

**c** Kunststoff · Plastic · Plastique

**d** Edelstahl · Stainless steel · Inox

**e** Akazie · Acacia · Acacia



## Heißer Stein

Hot stone · Pierre chaude

1 - 5

**16647** 4025457166471

2-teilig · 2 pieces · 2 pièces

Granitstein · Granite stone · Granit



## Grillstein

Hot stone · Pierre chaude

- 2\* 6

**16648** 4025457166488

Granitstein · Granite stone · Granit

# Savor

Granitstein  
Granit Stone  
Granit

**Heißer Stein Savor**  
Hot stone · Pierre chaude

1 - 1

**16643** 4025457166433

6-teilig · 6 pieces · 6 pièces

**a** Granitstein · Granite stone · Granit  
39 x 21 cm

**b** Metall schwarz · Metal black · Métal noir

**c** Edelstahl · Stainless steel · Inox

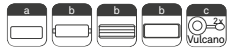

**Vulcano**  
Long Sicherheits-Pastenbrenner

**Pastenbrenner mit extra langem Griff, für sicheres Entnehmen.**

Paste burner with ultra-long handle, for secure removal.

Brûleurs à pâte avec manche extra long, pour utilisation en toute sécurité.



Gilt nur für Topf.  
Applies only to pot.  
Valable uniquement pour le caquelon.

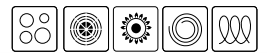

**Fonduekarussell Lugano**

Fondue carrousel · Carrousel à fondue

1 - 1

**61203** 4025457612039

22-teilig · 22 pieces · 22 pièces

**a** Emailliert · Enamelled · Emaillé  
**b** Edelstahl · Stainless steel · Inox  
**c** Metall verchromt  
Metal chromed · Métal chromé

**d** Keramik · Ceramic · Céramique

**e** Kunststoff · Plastic · Plastique

**f** 18/10 Edelstahl · Stainless steel · Inox

Für ca. 0,8 - 1,0 L Öl oder Brühe  
For about 0,8 - 1,0 L oil or broth  
Pour 0,8 - 1,0 L d'huile ou de bouillon

Schwarz · Black · Noir



**Fondue-Set Cailin**

Fondue-set · Service à fondue

1 - 4

**10968** 4025457109683

10-teilig · 10 pieces · 10 pièces

**a** 18/10 Edelstahl · Stainless steel · Inox  
**b** Edelstahl · Stainless steel · Inox

Für ca. 1-1,2 L Öl oder Brühe  
For approx. 1-1,2 L oil or stock  
Pour environ 1-1,2 L d'huile ou de bouillon



**Fondue-Set Comore**

Fondue-set · Service à fondue

1 - 4

**16639** 4025457166396

11-teilig · 11 pieces · 11 pièces

**a** Gusseisen emailliert  
Cast iron enamelled ·  
Fonte de fer émailé

**b** Edelstahl · Stainless steel · Inox

**c** Metall verchromt  
Metal chromed · Métal chromé

Für ca. 0,6 - 0,8 L Öl oder Brühe  
For about 0,6 - 0,8 L oil or broth  
Pour 0,6 - 0,8 L d'huile ou de bouillon

Schwarz · Black · Noir



## Bern/Uri

Keramik · Rot  
Ceramic · Red  
Céramique · Rouge



**Käsefondue-Set Bern 2 L**

Cheese fondue-set  
Service à fondue à fromage

1 - 2

**61303** 4025457613036

10-teilig · 10 pieces · 10 pièces

- a Feuerfeste Keramik  
Ovenproof ceramic  
Céramique incombustible
- b Edelstahl · Stainless steel · Inox
- c Metall verchromt  
Metal chromed · Métal chromé

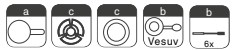

**Käsefonduepfanne Uri 2 L**

Cheese fondue pan  
Caquelon à fondue à fromage

1 - 4

**66582** 4025457665820



## Henrik

Keramik · Creme  
Ceramic · Cream  
Céramique · Crème



**Käsefondue-Set Henrik 2 L**

Cheese fondue-set  
Service à fondue à fromage

1 - 2

**16662** 4025457166624

9-teilig · 9 pieces · 9 pièces

- a Feuerfeste Keramik  
Ovenproof ceramic  
Céramique incombustible
- b Edelstahl · Stainless steel · Inox
- c Metall · Metal · Métal
- d Kunststoff · Plastic · Plastique



**Fondueteller Henrik**

Fondue plate · Assiette à fondue

1 6 12

**16661** 4025457166617

Matt · Matt · Mat



**Fondueschälchen Henrik**

Fondue bowl · Coupelle à fondue

1 4 36

**16660** 4025457166600

Matt · Matt · Mat

## Lancy

Aluguss · Keramische Beschichtung · Auch für Induktion geeignet  
Cast aluminum · Ceramic non-stick coating · Also suitable for induction hobs  
Fonte 'aluminium · Céramique revêtement antiadhésif · Compatible Induction



**Käsefondue-Set Lancy 2 L**

Cheese fondue-set  
Service à fondue à fromage

1 - 4

10-teilig · 10 pieces · 10 pièces

- a Aluguss · Cast aluminum · Fonte aluminium
- a Keramische Beschichtung  
Ceramic non-stick coating  
Céramique revêtement antiadhésif
- c Metall verchromt  
Metal chromed · Metal chromé
- d Edelstahl · Stainless steel · Inox
- e Griff: Antirutschoberfläche  
Handle: Non-slip surface  
Poignée: Surface antidérapante

**16564** 4025457165641

Grau · Grey · Gris



**Käsefonduepfanne Meyrin 2 L**

Cheese fondue pan  
Caquelon à fondue à fromage

1 - 6

Aluguss  
Cast aluminum · Fonte aluminium

Keramische Beschichtung  
Ceramic non-stick coating  
Céramique revêtement antiadhésif

Griff: Antirutschoberfläche  
Handle: Non-slip surface  
Poignée: Surface antidérapante

**16571** 4025457165719

Grau · Grey · Gris



NEW

**Roman**  
Keramik · Schwarz  
Ceramic · Black  
Céramique · Noir



**Käsefondue-Set**

Cheese fondue-set  
Service à fondue à fromage

1 - 2

**16665** 4025457166655

9-teilig · 9 pieces · 9 pièces

- a Feuerfeste Keramik  
Ovenproof ceramic  
Céramique incombustible
- b Edelstahl · Stainless steel · Inox
- c Metall · Metal · Métal
- d Kunststoff · Plastic · Plastique



# Für Naschkatzen

Schokofondues aus Keramik (Teelicht nicht enthalten)  
 Chocolate fondue Ceramic (without tealight)  
 Set fondue à chocolat céramique (sans bougie chauffe-plat)



**Schokofondue-Set Fiore 250 ml**  
 Chocolate fondue set  
 Set fondue à chocolat

1 - 6

**12423** 4025457124235

7-teilig · 7 pieces · 7 pièces

a Keramik · Ceramic · Céramique  
 b Edelstahl · Stainless steel · Inox  
 c Kunststoff · Plastic · Plastique

Braun/Hellbraun  
 Brown/Light brown · Brun/Brun clair



**Schokofondue-Set Alicia 200 ml**  
 Chocolate fondue set  
 Set fondue à chocolat

1 - 8

**12426** 4025457124266

4-teilig · 4 pieces · 4 pièces

a Keramik · Ceramic · Céramique  
 b Edelstahl · Stainless steel · Inox  
 c Kunststoff · Plastic · Plastique

Weiß · White · Blanc



**Schokofondue-Set Leonia 400 ml**  
 Chocolate fondue set  
 Set fondue à chocolat

1 - 12

**12421** 4025457124211

4-teilig · 4 pieces · 4 pièces

a Keramik · Ceramic · Céramique  
 b Edelstahl · Stainless steel · Inox  
 c Holz · Wood · Bois

Opalgrau/Creme  
 Opal grey/cream · Gris opal/Crème



## Zubehör

Fondueteller, Pastenbrenner und Rechaud  
Fondue plates, gel burners and rechauds  
Assiette à fondue, brûleur à pâte et rechaud



**Fondueteller Anneli**  
Fondue plate · Assiette à fondue  
1 6 12  
**67403** 4025457674037  
Feuerfeste Keramik · Ovenproof ceramic ·  
Céramique incombustible  
Glänzend · Bright · Brillant



**Fondueteller Vroni**  
Fondue plate · Assiette à fondue  
1 6 12  
**67406** 4025457674068  
Feuerfeste Keramik · Ovenproof ceramic ·  
Céramique incombustible  
Glänzend · Bright · Brillant



**Fondueteller Anneli**  
Fondue plate · Assiette à fondue  
1 6 12  
**67404** 4025457674044  
Feuerfeste Keramik · Ovenproof ceramic ·  
Céramique incombustible  
Glänzend · Bright · Brillant



**Fondueteller Vroni**  
Fondue plate · Assiette à fondue  
1 6 12  
**67405** 4025457674051  
Feuerfeste Keramik · Ovenproof ceramic ·  
Céramique incombustible  
Glänzend · Bright · Brillant

Vulcano  
Long Sicherheits-Pastenbrenner



**Pastenbrenner-Set Vesuvius**  
Set of paste burner · Set brûleur à pâte  
1 - 25  
**63067** 4025457630675  
Edelstahl · Stainless steel · Inox  
Brennpaste  
Combustible paste · Pâte à brûler  
UN 1170



**Pastenbrenner-Set Vulcano**  
Set of paste burner · Set brûleur à pâte  
1 - 72  
**63085** 4025457630859  
Edelstahl · Stainless steel · Inox  
Brennpaste  
Combustible paste · Pâte à brûler  
UN 1170



**Brennpasten-Set Magma**  
Set of combustible paste  
Set pâte à brûler  
1 - 24  
**63018** 4025457630187  
3 x 80 g  
UN 1170



**Rechaud Maxi**  
Rechaud · Réchaud  
1 - 12  
**60127** 4025457601279  
3-teilig · 3 pieces · 3 pièces  
a Edelstahl · Stainless steel · Inox  
b Metall verchromt  
Metal chromed · Métal chromé

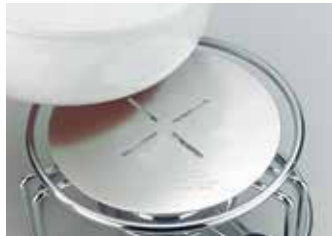

Verteilt die Hitze gleichmäßig auf dem Boden der Käsefonduetopfes und verhindert somit das Anbrennen.  
Distributes the heat evenly, to prevent cheese burning on.  
Réparti la chaleur sous le caquelon de fondue à fromage pour une cuisson uniforme.



**Flammenverteiler Balerno**  
Heat regulating plate  
Répartiteur de chaleur  
1 5 250  
**66595** 4025457665950  
Aluminium · Aluminium · Aluminium





# Zubehör Fondue

Fleischfonduegabeln & Fondueöffel  
Fondue fork & Fondue spoons  
Fourchette à fondue & Cuillères à fondue

Edelstahl  
Stainless steel · Inox

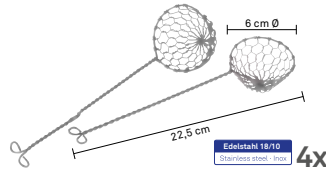

**Siebe-Set Tamis**  
Strainer set · Set passoires mini

1 - 60

**77924** 4025457779244



Fleischfonduegabeln  
Fondue fork  
Fourchette à fondue



25 cm **6x**

**Belana**

1 12 48

**79184** 4025457791840

Griff · Handle · Poignée  
Edelstahl · Stainless steel · Inox



24,5 cm **6x**

**Morena**

1 12 48

**79313** 4025457793134

Griff · Handle · Poignée  
Kunststoff · Plastic · Plastique



24,5 cm **6x**

**Modessa**

1 12 48

**79164** 4025457791642

Griff · Handle · Poignée  
Akazie · Acacia · Acacia

Käsefonduegabeln  
Cheese fondue fork  
Fourchette à fondue au fromage



25,5 cm **6x**

**Belana**

1 12 48

**79186** 4025457791864

Griff · Handle · Poignée  
Edelstahl · Stainless steel · Inox



25 cm **6x**

**Morena**

1 12 48

**79314** 4025457793141

Griff · Handle · Poignée  
Kunststoff · Plastic · Plastique



24,5 cm **6x**

**Bergamo**

1 12 48

**79167** 4025457791673

Griff · Handle · Poignée  
Buche · Beech · Hêtre

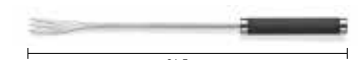

24,5 cm **6x**

**Montana**

1 12 48

**16581** 4025457165818

Griff: Antirutschoberfläche  
Handle: Non-slip surface  
Poignée: Surface antidérapante

Grau · Grey · Gris

Schokofonduegabel  
Chocolate fondue fork  
Fourchette à fondue au chocolat



18 cm **4x**

**Sweet**

1 12 72

**79194** 4025457791949

Griff · Handle · Poignée  
Kunststoff · Plastic · Plastique

Hygienekonzept · Hygiène · Hygiene concept

# HYGIENEPLUS



# Aurie Comfort

ABS Kunststoff · Ohne Batterie · **Nur für flüssiges Desinfektionsmittel**  
 ABS-Plastic · Without Batterie · **Liquid disinfectant only**  
 ABS Plastique · Sans fournie · **Désinfectant liquide uniquement**

**NEW**



**Kontaktlos**  
Contactless  
Sans contact

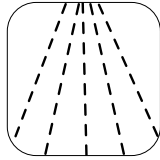

**Weniger Verbrauch**  
Less consumption  
Moins de consommation



**Standfest**  
Stable  
Stable



**Standby Modus**  
Standby mode  
Mode veille

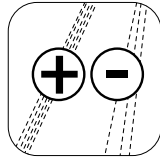

**2 Spraystufen**  
2 spray levels  
2 niveaux de dosage



**Spritzwassergeschützt**  
Splashproof  
Résistant aux éclaboussures

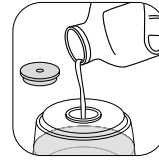

**Einfaches Befüllen**  
Simple to fill  
Remplissage facile



**Desinfektionsspender 360 ml**

Desinfectant dispenser  
Distributeur de désinfectant

1 - 20

**24510** 4025457245107

Weiß · White · Blanc



**Desinfektionsspender 360 ml**

Desinfectant dispenser  
Distributeur de désinfectant

1 - 20

**24511** 4025457245114

Dunkelgrau · Dark grey · Gris foncé

**Nur für flüssige Desinfektionsmittel**



# Aurie 300 / Aurie 450

ABS Kunststoff · **Für Seife und Desinfektionsmittel**  
 ABS-Plastic · **For soap and disinfectants**  
 ABS Plastique · **Pour le savon et les désinfectants**

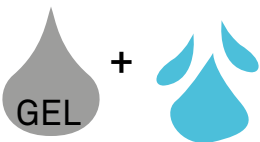

Die Auffangschale und der Clip können abgenommen werden

The drip tray and clip can be removed

Le plateau d'égouttement et le clip peuvent être retirés



**SOAP + DESINFECTANT**



**Für Seife und Desinfektionsmittel**





**NEW**

## Aurie Comfort

ABS Kunststoff · Ohne Batterie · **Nur für Flüssigseife**

ABS-Plastic · Without Batterie · **Only for soap**

ABS Plastique · Sans fournie · **Convient uniquement pour le savon**



**Kontaktlos**  
Contactless  
Sans contact



**Weniger Verbrauch**  
Less consumption  
Moins de consommation

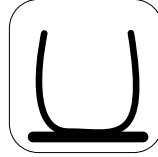

**Standfest**  
Stable  
Stable

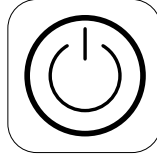

**Standby Modus**  
Standby mode  
Mode veille

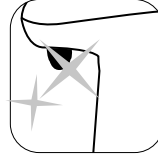

**Automatische Reinigungsfunktion**  
Auto clean function  
Système de nettoyage automatique



**5 Dosierstufen**  
5 volume levels  
5 niveaux de dosage



**Spritzwassergeschützt**  
Splashproof  
Résistant aux éclaboussures



**Einfaches Befüllen**  
Simple to fill  
Remplissage facile



**Seifenspender 350 ml**  
Liquid soap dispenser  
Distributeur à savon

1 - 20

**24512** 4025457245121

Weiß · White · Blanc



**Seifenspender 350 ml**  
Liquid soap dispenser  
Distributeur à savon

1 - 20

**24513** 4025457245138

Dunkelgrau · Dark grey · Gris foncé

**Nur für Flüssigseife geeignet**



**Seifen- und Desinfektionsmittel-spender 300 ml**  
Desinfectant dispenser  
Distributeur de désinfectant

1 - 24

**24505** 4025457245053

Hellgrau · Light grey · Gris clair



**Seifen- und Desinfektionsmittel-spender 300 ml**  
Desinfectant dispenser  
Distributeur de désinfectant

1 - 24

**24506** 4025457245060

Dunkelgrau · Dark grey · Gris foncé



**Seifen- und Desinfektionsmittel-spender 450 ml**  
Desinfectant dispenser  
Distributeur de désinfectant

1 - 24

**24507** 4025457245077

Hellgrau · Light grey · Gris clair



**Seifen- und Desinfektionsmittel-spender 450 ml**  
Desinfectant dispenser  
Distributeur de désinfectant

1 - 24

**24508** 4025457245084

Dunkelgrau · Dark grey · Gris foncé

## Purana / Benito

### Spülstation und Besteckabtropfer

Dishwashing center and cutlery holder

Distributeur à savon multi usages et Egouttoir à couvert



Fach passend für Glänzerkissen 11647  
Suitable for Sparkle sponge 11647  
Conçu pour l'éponge métallique 11647



#### Spülstation Purana 350 ml

Dishwashing center  
Distributeur à savon multi usages

1 - 12

12080 4025457120800

Keramik mit soft touch  
Ceramic with soft touch  
Céramique avec soft touch

Weiß · White · Blanc

#### Spülstation Purana 350 ml

Dishwashing center  
Distributeur à savon multi usages

1 - 12

12081 4025457120817

Keramik mit soft touch  
Ceramic with soft touch  
Céramique avec soft touch

Hellgrau · Light grey · Gris clair

#### Besteckabtropfer Benito

Cutlery holder  
Egouttoir à couvert

1 - 12

11668 4025457116681

Edelstahl · Stainless steel · Inox

PP-Kunststoff · PP plastic · PP-plastique

Matt · Matt · Mat

#### Besteckabtropfer Benito

Cutlery holder  
Egouttoir à couvert

1 - 12

11659 4025457116599

Metall farbig beschichtet  
Colour-coated metal  
Métal revêtement couleur

PP-Kunststoff · PP plastic · PP-plastique

Weiß · White · Blanc

## Pano

### Edelstahl

Stainless steel

Inox



Hohe Reinigungswirkung –  
ideal für Edelstahlkochgeschirr.

Excellent cleaning effect -  
Ideal for stainless steel cookware.

Grande propriété nettoyante -  
Idéal pour ustensiles de cuisson.

## Pulito

### Polyester

Polyester

Polyester



Kratzt nicht 3 – Ideal für beschichte-  
te Pfannen & Ceranfelder.

Non-scratch - Ideal for coated pans &  
ceramic hobs.

Ne raye pas - Idéal pour poêles à re-  
vêtement & plaques vitro-céramiques.

## Vision

### Edelstahl 18/10

Stainless steel 18/10

Inox 18/10



Für Glaskeramikfelder oder  
andere glatte Oberflächen.

For glass ceramic panels or other  
smooth surfaces.

Pour panneaux en vitrocéramique  
ou autres surfaces lisses.



#### Reinigungsbälle 15 g

Cleaning balls  
Eponges inox

- 12\* 72

11648 4025457116483



#### Glänzerkissen Pulito

Sparkle sponges  
Eponges métalliques

- 6\* 24

11647 4025457116476



#### Kochfeldreiner Vision

Ceran hob cleaner  
Grattoir à plaques vitro céramique

1 12 144

19248 4025457192487



#### Ersatzklingen-Set Vision

Replacement blades  
Lames de remplacement

1 10 100

22001 4002632921636

Metall · Metal · Métal

# SAUBERKEIT



#### Silent Close

Alle Treteimer mit diesem Symbol sind mit einem mit einem Geräusch dämpfenden Mechanismus versehen. Wir gewähren auf dieses System 5 Jahre Garantie.



#### Inneneimer PAK-frei

Alle Inneneimer unserer Kosmetik- & Treteimer können einfach entnommen werden, dank Henkel oder Loch.

#### Silent Close

All pedal bins with this symbol feature a soft closing mechanism. We also offer a 5-year warranty on this system.

#### Inner bin is PAK-free

All the inner bins of our cosmetic & pedal bins can also be removed using the handle or hole.

#### Silent Close

Toutes les poubelles à pédale avec ce symbole sont équipées d'un système de fermeture ralenti. De plus ce système est garanti 5 ans.

#### Seau amovible intérieur sans PAK

Tous les seaux amovibles de nos poubelles de salle de bain et à pédale se retirent facilement à l'aide d'une hanse ou d'un trou.



# Davino

Edelstahl · Pulverbeschichtet · **Silent Close-System**  
 Stainless steel · Power coated · **Silent Close-System**  
 Inox · Revêtu par poudre · **Silent Close-System**



- Platzsparend - dank der geraden Form passt Davino ganz eng an die Wand und in jede Ecke.
- Geräuschloser Deckelverschluss durch das Silent Close-System.
- Tragegriff an der Rückseite.
- Loch im Inneneimer zur Fixierung des Müllbeutels.
- Space-saving - Davino fits closely against the wall, thanks to its straight shape.
- Silent lid closing, thanks to the Silent Close-System.
- Carry handle on the rear.
- Hole in the inner bin to fix the waste bag.
- Sa forme rectangulaire permet un gain de place.
- Fermeture silencieuse avec.
- Système Silent-Close.
- Poignée de portage.
- Trou à l'intérieur du seau pour la fixation du sac poubelle

## Matt · Matt · Mat



Treteimer			
Dust bin · Poubelle			
1	-	4	6 L
<b>22998</b>	4025457229985		
1	-	4	12 L
<b>10902</b>	4025457109027		
1	-	2	30 L
<b>10903</b>	4025457109034		
Matt · Matt · Mat			



Treteimer			
Dust bin · Poubelle			
1	-	4	6 L
<b>22975</b>	4025457229756		
1	-	4	12 L
<b>10922</b>	4025457109225		
1	-	2	30 L
<b>10923</b>	4025457109232		
Matt · Matt · Mat			
Schwarz · Black · Noir			



Treteimer			
Dust bin · Poubelle			
1	-	4	6 L
<b>22976</b>	4025457229763		
1	-	4	12 L
<b>10924</b>	4025457109249		
1	-	2	30 L
<b>10934</b>	4025457109348		
Matt · Matt · Mat			
Grau · Grey · Gris			

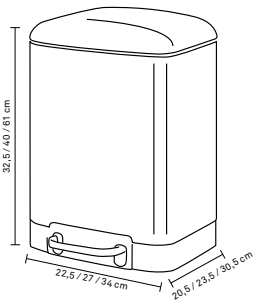

## Glänzend · Bright · Brillant



Treteimer			
Dust bin · Poubelle			
1	-	4	6 L
<b>22997</b>	4025457229978		
1	-	4	12 L
<b>10906</b>	4025457109065		
1	-	2	30 L
<b>10907</b>	4025457109072		
Glänzend · Bright · Brillant			
Hellgrau · Light grey · Gris clair			



Treteimer			
Dust bin · Poubelle			
1	-	4	6 L
<b>22992</b>	4025457229923		
1	-	4	12 L
<b>10908</b>	4025457109089		
1	-	2	30 L
<b>10909</b>	4025457109096		
Glänzend · Bright · Brillant			
Dunkelgrau · Dark grey · Gris foncé			



Treteimer			
Dust bin · Poubelle			
1	-	4	6 L
<b>22996</b>	4025457229961		
1	-	4	12 L
<b>10904</b>	4025457109041	<b>22,22</b>	
1	-	2	30 L
<b>10905</b>	4025457109058		
Glänzend · Bright · Brillant			
Weiß · White · Blanc			

Raumsparende  
Form



# Mats

Metall Mattoptik · Farbig beschichtet · **Silent Close-System**  
Metal matt · Colour coated · **Silent Close-System**  
Métal mat · Revêtement couleur · **Silent Close-System**



## Griff am Deckel für leichtes Öffnen

Handle in the lid  
Poignée sur le couvercle



## Geräuschloses Schließen

Silent close  
Fermeture silencieuse



Deckel rastet in senkrechter Position ein – dies erleichtert die Entnahme des Inneneimers.

Lid snaps into a vertical position - this makes it easier to remove the inner bucket.

Le couvercle se bloque en position verticale – ce qui facilite l'enlèvement du seau intérieur.



## Flacher Deckel

Flat lid  
Couvercle plat

## Griffmulde

Recessed grip  
Poignée encastrée

## Rutschhemmender Boden

Non-slip bottom  
Antidérapant sol



Super  
kompakt



# Mats 3 L

Metall Mattoptik · Farbig beschichtet · **Silent Close-System**  
 Metal matt · Colour coated · **Silent Close-System**  
 Métal mat · Revêtement couleur · **Silent Close-System**



**Kosmetikeimer 3 L**  
 Dust bin · Poubelle

---

1 - 6

---

**23617** 4025457236174

---

Wolkenrosa · Cloud pink · Rose nuage



**NEW**

**Beige · Beige · Beige**

---

**23619** 4025457236198



**Pastellrot · Pastel red · Rouge pastel**

---

**23618** 4025457236181



**Salbeigrün · Sage green · Saugé**

---

**23616** 4025457236167



**Nebelblau · Fog blue · Bleu brouillard**

---

**23611** 4025457236112



**Meerblau · Ocean blue · Bleu azur**

---

**23612** 4025457236129



**Weiß · White · Blanc**

---

**23613** 4025457236136



**Hellgrau · Light grey · Gris clair**

---

**23610** 4025457236105



**Schwarz · Black · Noir**

---

**23614** 4025457236143



Edelstahl  
 Stainless steel · Inox

**Matt · Matt · Mat**

---

**23615** 4025457236150

**NEW**

## Mats 5 L



**Kosmetikeimer 5 L**

Dust bin · Poubelle

1 - 6

**23700** 4025457237003

Hellgrau · Light grey · Gris clair

## Mats 12 L



**Treteimer 12 L**

Dust bin · Poubelle

1 - 4

**10640** 4025457106408

Hellgrau · Light grey · Gris clair



**Weiß · White · Blanc**

**23701** 4025457237010



**Beige · Beige · Beige**

**23704** 4025457237041



**Weiß · White · Blanc**

**10641** 4025457106415



**Beige · Beige · Beige**

**10644** 4025457106446



**Schwarz · Black · Noir**

**23702** 4025457237027



**Matt · Matt · Mat**

**23703** 4025457237034

Edelstahl  
Stainless steel · Inox



**Schwarz · Black · Noir**

**10642** 4025457106422



**Matt · Matt · Mat**

**10643** 4025457106439

Edelstahl  
Stainless steel · Inox



# Malta 12 L

Metall Mattoptik · Farbig beschichtet · **Silent Close-System**  
 Metal matt · Colour coated · **Silent Close-System**  
 Métal mat · Revêtement couleur · **Silent Close-System**



<b>Treteimer 12 L</b>	
Dust bin · Poubelle	
1	- 4
<b>10932</b>	4025457109324
Beige · Beige · Beige	



<b>Weiß</b> · White · Blanc	
<b>10929</b>	4025457109294



<b>Hellgrau</b> · Light grey · Gris clair	
<b>10933</b>	4025457109331



<b>Dunkelgrau</b> · Dark grey · Gris foncé	
<b>10942</b>	4025457109423



<b>Schwarz</b> · Black · Noir	
<b>10931</b>	4025457109317

# Kosmetik- und Treteimer

Edelstahl · **Silent Close-System**  
 Stainless steel · **Silent Close-System**  
 Inox · **Silent Close-System**



<b>Kosmetikeimer Stampa 3L</b>	
Dust bin · Poubelle	
1	- 6
<b>21887</b>	4025457218873
Glänzend · Bright · Brillant	



<b>Kosmetikeimer Impronta 3L</b>	
Dust bin · Poubelle	
1	- 6
<b>21888</b>	4025457218880
Matt · Matt · Mat	



<b>Treteimer Nila 12 L</b>	
Dust bin · Poubelle	
1	- 4
<b>10925</b>	4025457109256
Glänzend · Bright · Brillant	



<b>Treteimer Mala 12 L</b>	
Dust bin · Poubelle	
1	- 4
<b>10927</b>	4025457109270
Matt · Matt · Mat	

In matter  
Optik



## Monaco 3 L

Metall Mattoptik · Farbig beschichtet  
Metal matt · Colour coated  
Métal mat · Revêtement couleur



### Kosmetikeimer

Dust bin · Poubelle

1 - 6

Weiß · White · Blanc

**18160** 4025457181603

Hellgrau · Light grey · Gris clair

**21886** 4025457218866

Dunkelgrau · Dark grey · Gris foncé

**21885** 4025457218859



Currygelb · Curry yellow · Jaune curry

**24285** 4025457242854

Jadegrün · Jade green · Vert jade

**24287** 4025457242878

Alpengrün · Alps green · Vert alpes

**24295** 4025457242953



Polarblau · Polar blue · Bleu polaire

**24291** 4025457242915

Frostblau · Freeze blue · Bleu gelé

**24290** 4025457242908

Petrol · Teal blue · Petrol

**20528** 4025457205286

Malvenblau · Mauve blue · Bleu mauve

**24292** 4025457242922



Beige · Beige · Beige

**20900** 4025457209000

Karminrot · Carmine red · Rouge carmin

**24289** 4025457242892

Zartpuder · Tender powder · Poudre tendre

**24299** 4025457242991



Perlrosa · Perty pink · Rose perlé

**20525** 4025457205255

Opalflieder · Opal lilac · Opal lilas

**24293** 4025457242939

Pflaume · Plum · Prune

**24294** 4025457242946

Himbeerrot · Raspberry red · Framboise

**24297** 4025457242977



Schwarz · Black · Noir

**20903** 4025457209031

Cashmerebraun  
Cashmere brown · Brun cashmere

**20526** 4025457205262

## Torre & Dusty 3 L

Edelstahl  
Stainless steel  
Inox



### Kosmetikeimer

Dust bin · Poubelle

1 - 6

Torre Matt · Matt · Mat

**18172** 4025457181726

Dusty Glänzend · Bright · Brillant

**40435** 4025457404351



Passend zu  
Leonora



# Swing / Graphit

Schirmständer  
Umbrella stand  
Porte-parapluies

Auch als Papierkorb  
verwendbar

50 cm

21 cm

Edelstahl

## Schirmständer Swing

Umbrella stand · Porte-parapluies

1 - 2 

**18031** 4025457180316

Edelstahl · Stainless steel · Inox

Matt · Matt · Mat

## Schirmständer Graphit

Umbrella stand · Porte-parapluies

1 - 2 

**21364** 4025457213649

Metall farbig beschichtet

Colour-coated metal

Métal revêtement couleur

Schwarz · Black · Noir

# KNOW-HOW

Eine perfekte Markenpräsentation am POS ist der Schlüssel zum Erfolg. Mit der Marke kela bieten wir ein breites und vielfältiges Produkt-Spektrum für die Bereiche Tisch, Küche und Bad. Mit der passenden Produktpräsentation bieten wir Ihren Kunden eine einladende Shopatmosphäre, die sowohl die Produkte im richtigen Licht zeigt, als auch den Abverkauf und somit Ihren Umsatz steigert.

## ***Unser Know-How***

Wir unterstützen Sie mit einer professionellen Flächen- und Sortimentsplanung. Am Ende profitieren Sie von einer attraktiven kela-Verkaufsfläche, die den Ansprüchen Ihrer Kunden gerecht wird und immer wieder neue Kaufimpulse setzt.



# The key to success

## La clé du succès

Perfect presentation of the brand at the POS is the key to success. The kela brand offers a broad-based and varied product range for the table, kitchen and bathroom. Coordinated product presentation enables us to offer your customers an inviting store atmosphere, which showcases our products in the best light and hence generates sales and thus increases your turnover.

### **Our knowledge and expertise**

We can support you with professional shop floor and range planning. At the end, you will benefit from an attractive kela sales area that will meet your customers' demands and stimulate purchases time and time again.

Pour booster les ventes, rien de mieux qu'une présentation parfaite de la marque sur le point de vente. Avec la marque kela, nous vous proposons un assortiment très large et varié, dans le domaine de la Table, de la Cuisine et du Bain.

Une présentation des produits adéquate donnera une atmosphère unique, qui les mettra en valeur et invitera vos clients à les découvrir plus facilement, et permettra ainsi une hausse sensible de vos ventes.

### **Notre Savoir Faire**

Nos professionnels vous accompagnent par le biais d'une proposition de mise en place des articles sur votre point de vente, le but étant de vous faire profiter d'une présentation attractive qui provoquera des achats d'impulsion à vos clients.









# Perfekte Lösungen

*Perfect solutions*

*Des solutions parfaites*

Wir investieren viel Zeit und Energie für ein optimales, markengerechtes Verpackungsdesign unserer Produkte, das am POS für Aufmerksamkeit sorgt, wichtige Informationen transportiert, eine klare Auskunft über den Inhalt gibt und last but not least zum Kauf anregt.

We are investing a lot of time and energy in developing an optimum packaging design for our products to match the brand, which will attract attention at the POS, convey key information, provide clear information about the content and, last but not least, generate sales.

Nous investissons beaucoup de temps et d'énergie afin de proposer un packaging de nos produits, attrayant, design et adapté au marché.

Ce packaging attire l'œil sur le point de vente et apporte des informations importantes, une réponse claire du contenu et in fine, stimule l'envie d'achat.

Aufmerksamkeitsstarke Deko-Pakete stehen im Rahmen von Verkaufsaktionen zur Verfügung.

Eye-catching decorative packages will be available for sales promotions.

Pour nos actions promotionnelles, nous mettons a disposition des packaging déco spécifiques pour de nombreuses promotions.







Attraktiv und abverkaufsstark.  
Für viele Produkte bietet kela  
übersichtliche Einzelpräsentier, die  
den Anforderungen der Artikel  
gerecht werden und im Verkaufs-  
raum die Aufmerksamkeit der  
Konsumenten auf sich ziehen.

Attractive and sales-promoting  
kela also offers clearly designed single product  
displays for many products, which meet the  
needs of the products at the same time as  
drawing consumers' attention to them on the  
sales floor.

Attrayant et vendeur  
Pour de nombreux produits, kela propose des  
présentoirs individuels, mettant en valeur les  
produits afin d'attirer l'œil du consommateur.

# Wir freuen uns auf Ihren Besuch

*We look forward to your visit*

*Nous attendons votre visite  
avec impatience*

In unserem Showroom in Böhmenkirch präsentieren wir auf fast 500 qm Ausstellungsfläche unsere Neuheiten und das komplette Sortiment für Küche und Bad. In der Showküche finden Produktvorführungen und Produktschulungen für unsere Kunden statt. Unser Showroom ist ganzjährig geöffnet und kann jederzeit besucht werden. Wir bitten um Voranmeldung.

We showcase our new products and the complete range for kitchens and bathrooms on an area of some 500 square metres in our showroom in Böhmenkirch. Product demonstrations and training workshops are held in the demonstration kitchen. Our showroom is open throughout the year and can be visited at any time. Please register to ensure that we are available to you during your visit.

Nous vous proposons un Show Room d'environ 500m<sup>2</sup>, à Boehmenkirch – Allemagne, où vous trouverez toutes nos nouveautés ainsi que nos collections complètes de cuisine et de bain. Nos chefs vous présenteront, dans une cuisine équipée à cette occasion, des démonstrations culinaires et des formations produits. Notre Show Room est ouvert tout au long de l'année et sur demande. Merci de prendre rendez vous si vous êtes intéressés.





# Onlineshop B2B

*We look forward to your visit*

*Nous attendons votre visite  
avec impatience*

We want you to feel completely at home around kela. We also use our recently set up B2B online portal to inform you about current topics and the latest campaigns and promotions.

Your personal B2B account lets you find out the current status of your orders, view your customer data or place orders at any time and any place.

We look forward to your visit online.

Notre but est que vous vous sentiez bien avec kela. Notre nouveau portail online B2B vous informe sur nos dernières thématiques et nouveautés ainsi que sur les actions en cours.

Grâce à votre compte personnel B2B, vous pouvez à tous moments et où que vous soyez être informé sur l'état de votre commande en cours, vos données personnelles ou passer commande directement.

Nous nous réjouissons de votre visite Online.

Wir möchten, dass Sie sich bei kela rundum wohlfühlen. Auf unserem B2B Online-Portal informieren wir Sie über aktuelle Themen und Aktionen.

Mit Ihrem persönlichen B2B Account können Sie Bestellungen tätigen, sich jederzeit und überall über den aktuellen Stand Ihrer Aufträge informieren und Ihre Kundendaten einsehen.

Wir freuen uns auf Ihren Online-Besuch.

***b2b.kela.de***



# Index

Sie suchen eine bestimmte Artikelnummer? Hier finden Sie die passende Seitenzahl  
 Are you looking for a specific item number? Here you will find the matching page number  
 Vous recherchez un référence spécifique? Vous trouverez ici la page correspondante

<b>Artikel</b>	<b>Page</b>	10554	79	10904	140	11220	57	11648	138	11860	39	12024	71	12193	60
<b>10030</b>	55	10555	79	10905	140	11286	57	11652	41, 114	11862	39	12035	116	12194	61
10031	54	10584	79	10906	140	11287	57	11655	37	11863	39	12037	116	12195	61
10032	54	10585	79	10907	140	11288	57	11656	37	11865	39	12039	116	12196	61
10033	54	10586	79	10908	140	11304	58	11657	37	11870	71	12040	116	12197	61
10035	54	10590	79	10909	140	11348	56	11658	37	11871	71	12041	116	12198	60
10036	54	10591	79	10922	140	11349	56	11659	138	11872	71	12042	116	12199	61
10037	54	10592	79	10923	140	11355	86	11665	59	11873	70, 95	12043	116	12215	9
10038	54	10640	145	10924	140	11356	86	11668	138	11874	70	12044	116	12216	9
10050	42	10641	145	10925	146	11374	118	11670	32	11900	94	12045	116	12217	9
10051	42	10642	145	10927	146	11389	106	11674	32	11901	94	12046	116	12218	8
10052	42	10643	145	10929	146	11390	106	11675	32	11906	64	12050	102	12219	8
10053	42	10644	145	10931	146	11397	77	11682	70	11907	64	12051	102	12220	8
10056	51	10759	38	10932	146	11398	77	11684	115	11920	101	12052	102	12221	8
10057	51	10763	38	10933	146	11401	94	11685	38	11921	101	12053	102	12223	9
10061	51	10765	98	10934	140	11402	94	11686	38	11934	39	12060	104	12224	9
10062	51	10766	98	10942	146	11440	40	11687	38	11935	39	12061	104	12225	8
10066	51	10767	98	10947	38	11441	40	11688	38	11936	39	12062	104	12226	8
10067	51	10768	98	10948	38	11442	40	11707	114	11937	39	12063	104	12235	96
10071	51	10769	98	10955	32	11444	94	11708	114	11940	17	12064	103	12238	95
10072	51	10770	101	10956	32	11447	94	11709	114	11941	17	12066	103	12260	72
10076	51	10771	101	10957	32	11449	94	11715	62	11942	17	12067	103	12261	72
10077	51	10772	101	10958	32	11456	86	11717	62	11943	17	12068	103	12266	112
10081	51	10773	101	10959	32	11457	87	11720	63	11947	17	12080	138	12267	112
10082	51	10774	57	10960	32	11458	87	11723	63	11948	17	12081	138	12268	112
10171	27	10776	99	10961	32	11466	89	11730	110	11950	100	12095	119	12269	112
10172	27	10777	99	10962	32	11467	58	11731	110	11951	100	12096	117	12270	111
10173	27	10778	99	10963	32	11468	54	11732	110	11952	100	12097	119	12271	111
10174	27	10779	99	10964	32	11475	94	11733	110	11953	100	12098	119	12272	111
10175	27	10780	52	10965	32	11476	41	11734	110	11955	98	12102	64	12273	111
10176	27	10781	52	10966	32	11495	82	11736	110	11956	98	12103	64	12274	111
10177	27	10785	52	10968	33, 129	11496	82	11737	110	11957	98	12104	99	12275	111
10178	27	10807	81	10969	33	11497	92	11738	110	11958	98	12105	99	12276	111
10179	26	10808	81	10991	33	11498	92	11739	110	11971	65	12106	99	12277	111
10180	26	10826	38	10992	35	11549	12	11740	110	11972	65	12107	99	12278	111
10181	26	10835	80	10994	33	11550	12	11741	110	11973	65	12108	99	12279	111
10182	26	10836	80	10995	40	11552	12	11742	110	11974	65	12109	99	12280	111
10183	26	10848	81	10996	40	11553	12	11781	48	11975	65	12151	76	12281	111
10184	26	10849	81	<b>11074</b>	64	11554	12	11782	48	11976	65	12152	76	12285	113
10185	28	10851	81	11133	20	11555	12	11783	48	11977	65	12154	76	12286	113
10186	28	10852	81	11134	20	11560	13	11784	48	11978	65	12155	76	12287	113
10187	28	10866	56	11165	105	11561	13	11785	68	11980	65	12170	52	12288	113
10188	28	10869	80	11167	105	11563	12	11786	61	11981	65	12172	52	12289	113
10189	28	10870	40	11168	105	11564	13	11787	61	11982	65	12173	52	12290	113
10190	28	10871	40	11176	105	11567	13	11788	61	<b>12006</b>	68	12174	52	12291	113
10191	28	10872	40	11177	105	11568	13	11797	96	12007	70	12175	52	12292	113
10192	28	10873	40	11200	95	11612	59	11798	96	12008	70	12180	119	12293	113
10200	29	10879	80	11201	95	11613	59	11804	117	12009	70	12181	119	12294	113
10201	29	10884	80	11203	95	11616	21	11806	83	12010	71	12182	119	12295	113
10550	79	10900	82	11212	58	11617	21	11808	83	12011	105	12183	119	12296	113
10551	79	10901	82	11214	58	11619	59	11809	83	12012	105	12190	61	12298	113
10552	79	10902	140	11217	55	11642	114	11824	117	12013	105	12191	61	12300	71
10553	79	10903	140	11218	57	11647	138	11841	104	12014	70	12192	61	12305	23

# Index

Sie suchen eine bestimmte Artikelnummer? Hier finden Sie die passende Seitenzahl  
 Are you looking for a specific item number? Here you will find the matching page number  
 Vous recherchez un référence spécifique? Vous trouverez ici la page correspondante

12306	23	12485	91	12708	108	15326	45	17870	100	19219	62	24293	148	79186	134
12307	117	12486	91	12710	109	15365	56	17906	58	19243	89	24294	148	79194	134
12308	117	12487	91	12711	109	15474	14	18031	150	19246	89	24295	148	79313	134
12310	119	12490	83	12712	109	15475	14	18160	148	19248	138	24297	148	79314	134
12311	119	12491	83	12713	109	15476	14	<b>18172</b>	148	<b>20525</b>	148	24299	148		
12312	119	12492	83	12715	109	15633	118	<b>19000</b>	45	20526	148	24505	137		
12313	119	12493	83	12716	109	15634	118	19001	44	20528	148	24506	137		
12320	117	12500	124	12717	109	15638	118	19002	44	20900	148	24507	137		
12321	117	12501	124	12718	109	15641	118	19003	44	20903	148	24508	137		
12322	117	12502	124	12719	108	15644	118	19004	44	<b>21364</b>	150	24510	136		
12323	117	12503	124	12720	108	15715	56	19005	44	21885	148	24511	136		
12324	117	12509	93	12725	109	15716	56	19006	44	21886	148	24512	137		
12325	117	12510	92	12726	109	15727	53	19007	44	21887	146	24513	137		
12327	41, 114	12511	92	12727	108	15729	53	19009	45	21888	146	<b>40435</b>	148		
12328	41, 114	12513	82	12728	108	15740	53	19010	45	<b>22001</b>	138	<b>49552</b>	96		
12330	117	12516	71	12729	109	15741	53	19012	45	22975	140	49553	96		
12331	117	12535	77	12730	115	15931	45	19013	45	22976	140	49880	96		
12332	117	12536	77	12731	115	15961	115	19014	45	22992	140	<b>60127</b>	133		
12333	117	12537	88	12735	109	15963	115	19016	45	22996	140	61000	126		
12334	117	12538	88	12736	109	15964	115	19017	45	22997	140	61201	126		
12335	117	12539	88	12737	109	15969	115	19019	45	22998	140	61203	129		
12337	118	12541	93	12738	109	15970	115	19020	45	<b>23331</b>	49	61303	130		
12338	118	12542	93	12750	85	15971	115	19022	45	23332	49	61306	126		
12339	118	12543	93	12751	85	<b>16370</b>	14	19024	44	23333	49	<b>63018</b>	133		
12340	118	12544	88	12752	85	16564	130	19027	45	23335	49	63067	133		
12390	75	12552	68	12753	85	16571	130	19028	44	23338	49	63085	133		
12391	75	12553	68	12754	85	16581	134	19029	45	23341	49	<b>64006</b>	123		
12392	75	12561	91	12755	85	16639	129	19032	45	23344	49	<b>66470</b>	127		
12394	75	12562	91	12756	85	16640	128	19033	45	23347	49	66490	122		
12395	75	12564	90	12757	85	16643	129	19034	83	23349	49	66493	122		
12400	34	12569	91	12758	85	16644	128	19038	45	23354	49	66496	123		
12403	75	12571	47	<b>15001</b>	120	16647	128	19039	45	23355	49	66575	126		
12404	75	12572	47	15002	120	16648	128	19043	82	23610	144	66582	130		
12405	75	12573	47	15004	120	16660	130	19045	53	23611	144	66595	133		
12410	84	12574	47	15006	120	16661	130	19050	82	23612	144	66661	122		
12411	84	12575	47	15007	120	16662	130	19051	82	23613	144	66663	122		
12412	84	12576	47	15008	120	16665	131	19052	82	23614	144	66667	123		
12417	75	12580	50	15011	120	16920	95	19054	64	23615	144	66980	125		
12418	75	12581	50	15012	120	16922	86	19055	64	23616	144	<b>67403</b>	133		
12421	132	12582	50	15014	120	16940	87	19056	64	23617	144	67404	133		
12423	132	12583	50	15017	120	16941	87	19058	64	23618	144	67405	133		
12426	132	12584	50	15018	120	16945	58	19061	44	23619	144	67406	133		
12470	19	12585	50	15019	120	<b>17116</b>	41	19062	45	23700	145	<b>77033</b>	123		
12471	19	12600	22	15150	13	17253	49	19065	47	23701	145	77080	72		
12472	19	12601	22	15151	13	17300	49	19087	55	23702	145	77085	72		
12473	19	12602	22	15152	12	17302	49, 57	19088	55	23703	145	77747	36		
12474	19	12700	108	15153	12	17304	49	19092	89	23704	145	77905	36		
12475	12	12701	108	15154	13	17580	89	19099	58	<b>24285</b>	148	77924	134		
12480	90	12702	108	15155	13	17582	95	19123	55	24287	148	77937	123		
12481	90	12703	108	15156	13	17600	96	19135	45	24289	148	77943	36		
12482	38, 91	12705	108	15157	12	17867	100	19139	44	24290	148	<b>79164</b>	134		
12483	38, 91	12706	108	15314	82, 89	17868	100	19140	44	24291	148	79167	134		
12484	91	12707	108	15315	58	17869	100	19200	89	24292	148	79184	134		

## Allgemeine Verkaufs- und Lieferbedingungen der Keck & Lang GmbH

Die Angebote in diesem Katalog richten sich ausschließlich an Unternehmer, Händler oder Gewerbetreibende, die bei Abschluss eines Kaufs in Ausübung ihrer gewerblichen oder selbständigen Tätigkeit handeln, nicht an Verbraucher i.S.d. § 13 BGB. Eine Weiterreichung dieses Katalogs an Verbraucher ist untersagt.

Ein Vertragsschluss erfolgt ausschließlich auf der Grundlage unserer AGB, welche wir Ihnen auf Wunsch gerne zur Verfügung stellen und welche Sie auch auf unserer Homepage unter <https://b2b.kela.de/html/de/produktmarke/kataloge-broschueren/> einsehen können.

Die Produktabbildungen und Zeichnungen in diesem Katalog unterliegen Urheber- und Verwertungsrechten, welche ausschließlich bei uns liegen. Jede nicht von uns autorisierte Nutzung und Vervielfältigung ist untersagt und wird von uns verfolgt.

## General terms and conditions of sale and delivery of Keck & Lang GmbH

The offers in this catalogue are solely geared to entrepreneurs, dealers or traders who, in the event of a purchase, exercise their commercial or self-employed work, and not to consumers within the meaning of Section 13 of the German Civil Code (BGB). Passing this catalogue to consumers is prohibited.

A contract will only be concluded on the basis of our Terms and Conditions of Sale, which we would be pleased to provide you with on request and which you can view on our website at <https://b2b.kela.de/html/en/product-brand/catalogues-brochures/>

The product illustrations and drawings in this catalogue are subject to copyright and exploitation rights that we exclusively own. Any use and reproduction not authorised by us is prohibited and will be prosecuted by us.

## Conditions générales de vente et de livraison de la société Keck & Lang GmbH

Les offres de ce catalogue s'adressent uniquement aux professionnels , revendeurs et commerçants qui de part leur activité en font un usage professionnel, et non au consommateur final i.S.d. § 13 BGB.

Il est formellement interdit de transmettre ce catalogue à un consommateur final. Cet accord se base sur nos Conditions Générales de Vente, que nous mettons à votre disposition à votre demande et que vous pouvez consulter sur notre page Web <https://b2b.kela.de/html/fr/marque-de-produit/catalogues-brochures/>

Les photographies, illustrations et descriptions sont la propriétés de kela et sont soumis à autorisations de droit d'exploitation. Tout usage ou duplication sans autorisation est interdit et sera poursuivi devant les tribunaux.