



PETKIT P591 YUMSHARE Dual Hopper with Camera Smart Pet Feeder User Manual

[Home](#) » [PETKIT](#) » PETKIT P591 YUMSHARE Dual Hopper with Camera Smart Pet Feeder User Manual 

Contents

- [1 PETKIT P591 YUMSHARE Dual Hopper with Camera Smart Pet Feeder](#)
- [2 PRODUCT LIST](#)
- [3 PRODUCT DESCRIPTION](#)
- [4 PRODUCT INSTALLATION](#)
- [5 HOW TO USE](#)
- [6 CLEANING AND MAINTENANCE](#)
- [7 VIDEO GUIDE](#)
- [8 USER SAFETY GUIDE](#)
- [9 FCC](#)
- [10 Documents / Resources](#)

PETKIT

PETKIT P591 YUMSHARE Dual Hopper with Camera Smart Pet Feeder



PRODUCT LIST

*Please confirm the accessories are complete before installation and use.



Main Unit

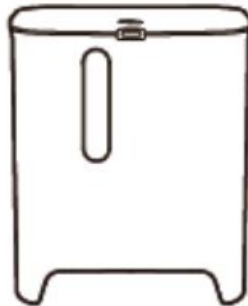

Food Storage Container



Stainless Steel
Food Bowl

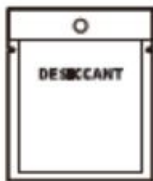

Desiccant

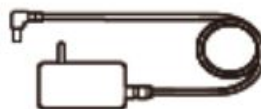

Adapter



User Manual

***Note:** in order to provide a better user experience, we will be implementing periodic product enhancements. Product images are shown for illustration purposes only. The actual product may vary from the image shown on the box. For any discrepancies, please refer to the actual product.

PRODUCT DESCRIPTION

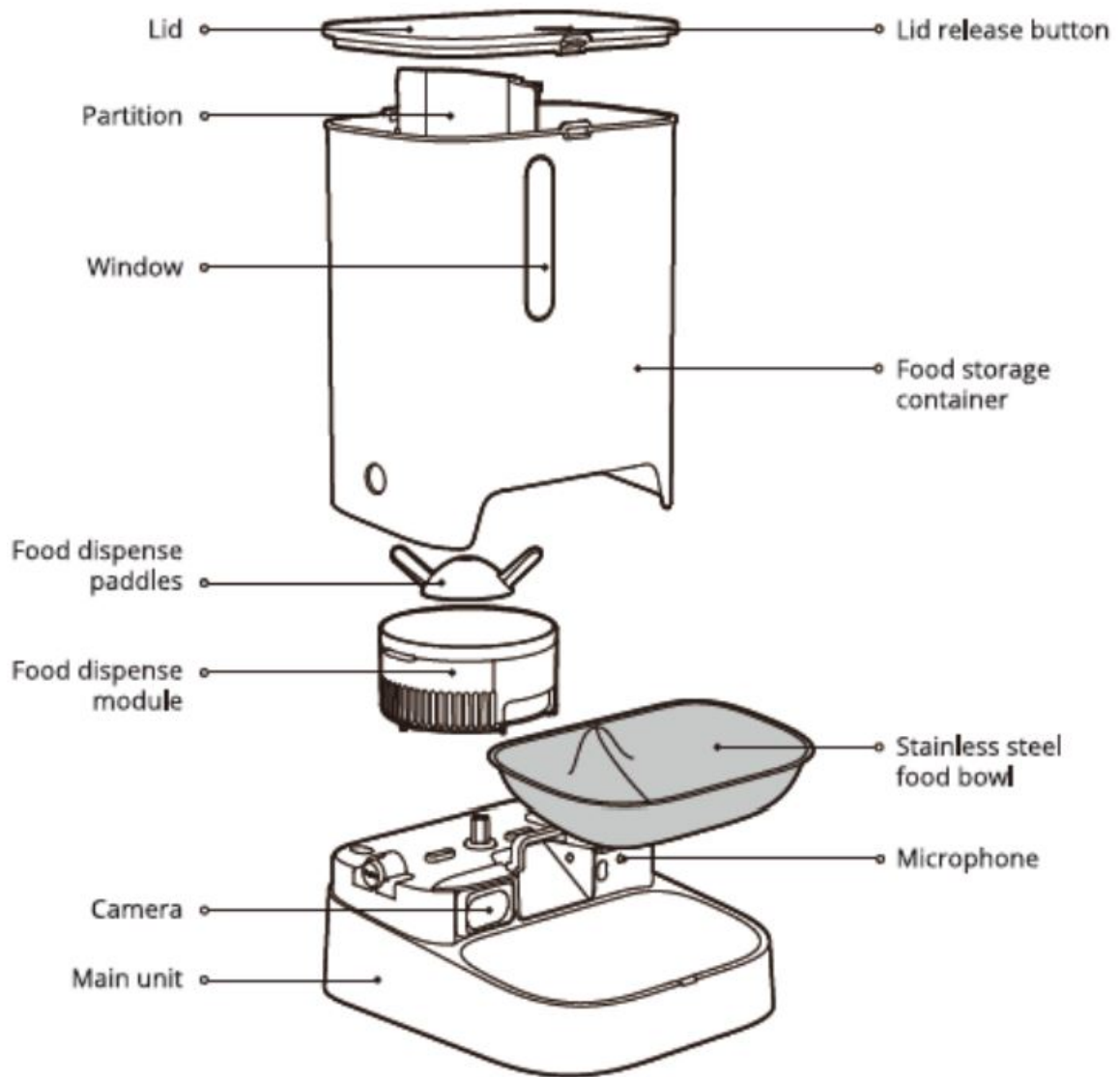

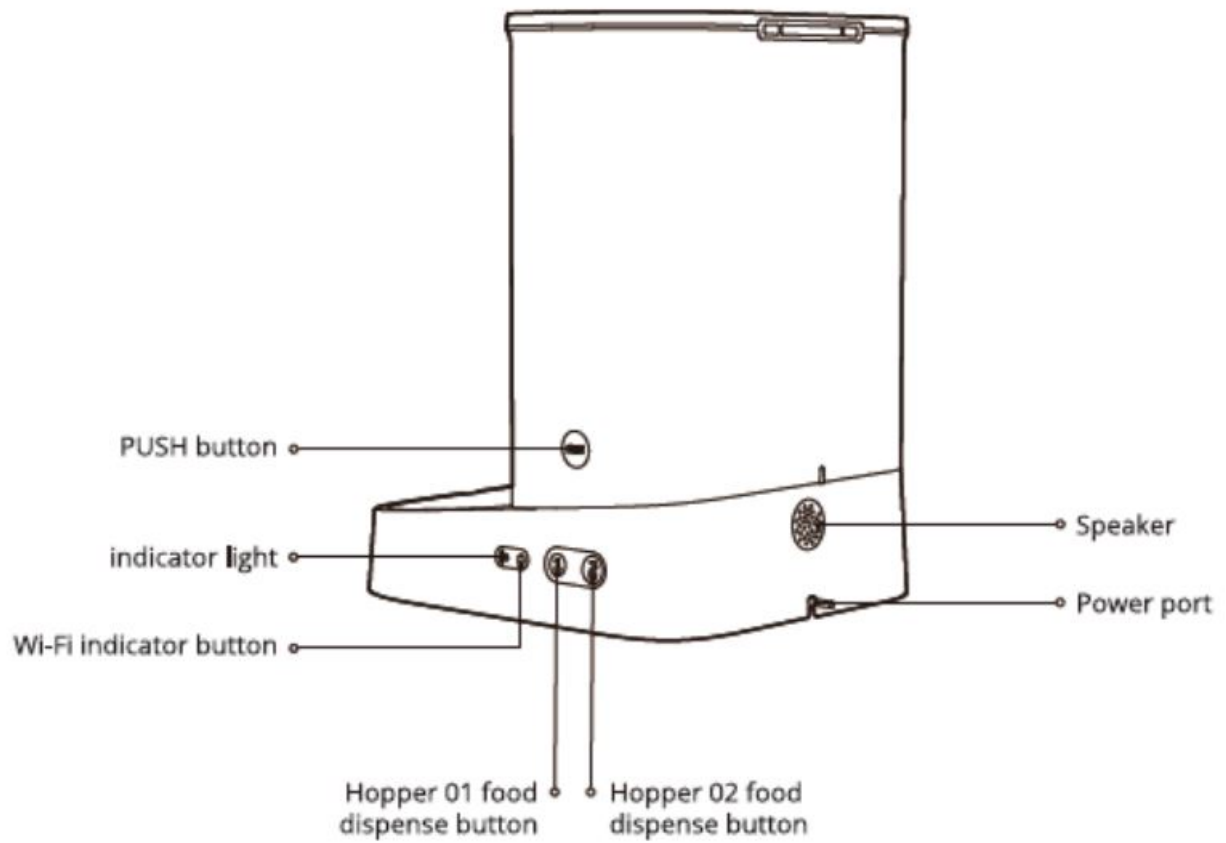

PRODUCT INSTALLATION

Install the main unit



1. Place the main unit on the level ground or desk.
2. Lift the food storage container, align the circular notches on both sides of the container with the PUSH button on the main unit, and place it vertically downwards.
3. Press and hold the PUSH buttons until they are fully stuck into the circular notches.
4. Place the stainless steel food bowl in the food bowl stand.

Connect the power supply

Take out the power adapter cord and attach it to the power adapter port on the back.

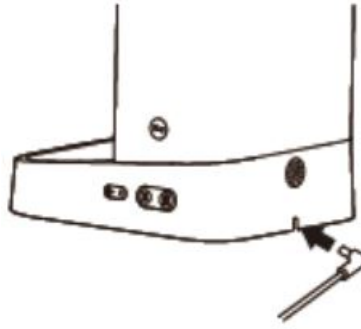

Install the backup batteries

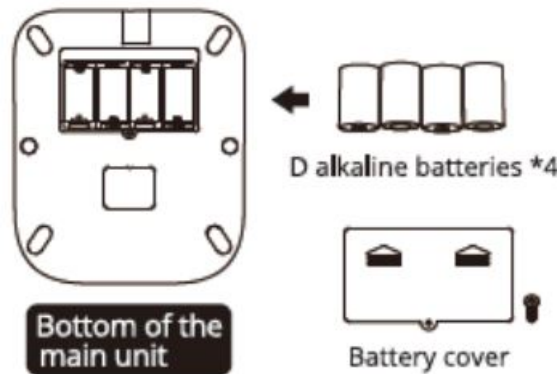

1. Take out the screw and remove the battery cover.
2. Take four D batteries and place them in the battery compartment. (Pay attention to the orientation of the positive and negative ends)
3. Put the battery cover back on and tighten down the screw.

Choose whether to install batteries based on personal actual usage needs. (Batteries need to be purchased separately, and only alkaline batteries can be used)

***Note:** When the battery is low, please replace the batteries in time. Check and replace the batteries before leaving the device unattended for an extender period of time.

Install the desiccant

1. Press and hold the lid release button to the right and lift up to remove the lid.

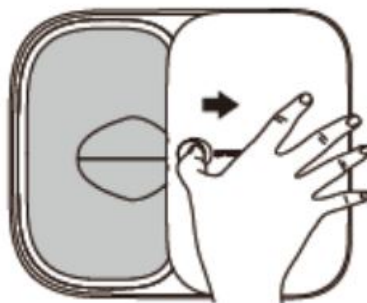

2. Open the desiccant compartment, take the desiccant packet, and lay it down evenly in the compartment, Then close the desiccant.

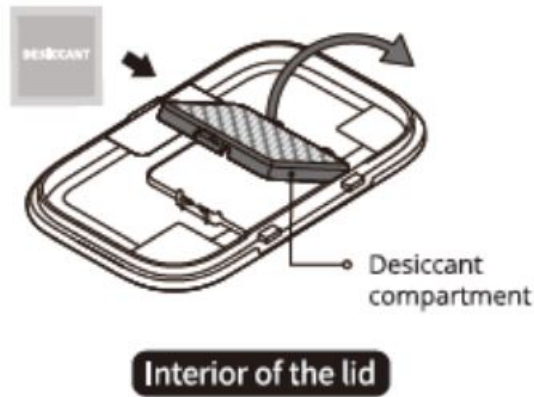

HOW TO USE

Add pet food

1. Add pet food. (do not exceed the MAX line)

Two different pet foods can be placed in Hopper 01 and Hopper 02 according to your finding needs.

Note: Do not pull out the partition if there is food left inside.

*Suggest using dry food dimensions: s 12mm/0.471n suggest using freeze-dried food diameters 9mm/ 0.35in

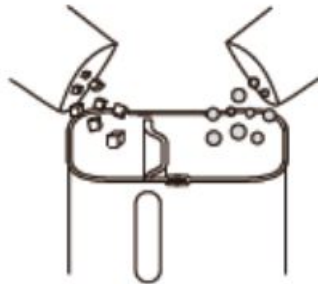

2. Cover the lid: Insert the rear side of the lid into the two holes above the food storage container.



Indicator light

The indicator light can be turned on/off in the app. When using the batteries, the indicator light will be turned off.

Indicator light	Status
White light is flashing slowly	Device is offline, there is no internet connection
White light is flashing quickly	Device is connecting to the Wi-Fi
White light is constantly on	Device is connected to Wi-Fi (Camera is not working)
Green light is constantly on	Device is connected to Wi-Fi (Camera is working)

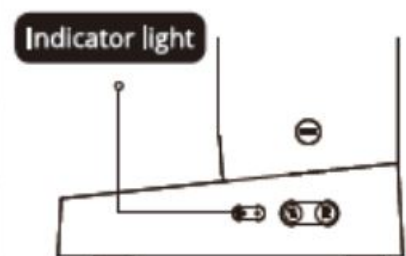

Manual feeding

Select 01 or 02 hopper button. Press the button to start dispensing; Release the button to end dispensing.

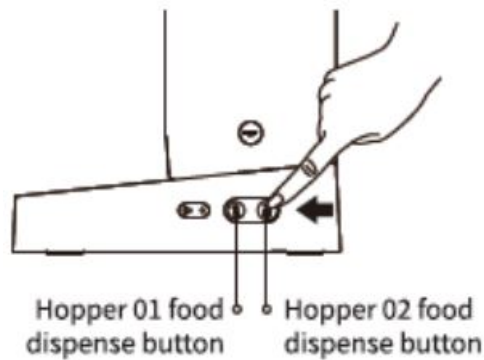

App smart control

App Download and Installation Download PETKIT App from the App Store or Google Play. Click “+” to add the corresponding device, and bind the device according to the guides.



Scan the tile QR code to download PETKIT App.

1. Feeding plans can be set in the app, and the feeder will automatically dispense food at a set time every day according to the plan. You will receive prompt messages and timely notice of the food dispense and feeding status.
2. The app support real-time viewing of monitor and voice interaction. At the same time, you can also share and review the monitor images. More exciting features can be experienced in the app.

CLEANING AND MAINTENANCE

1. Open the lid to remove the desiccant, pull out the part tion vertically upward, and then remove the food bowl.

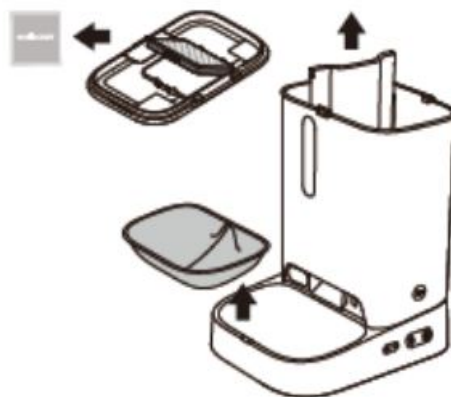

2. Hold the PUSH buttons on both sides of the main unit with your middle fingers, and lift it up at the same time to remove the food storage container.



3. Pull out the food storage container. Rotate clockwise to, remove the Impeller cover and take out the impeller.

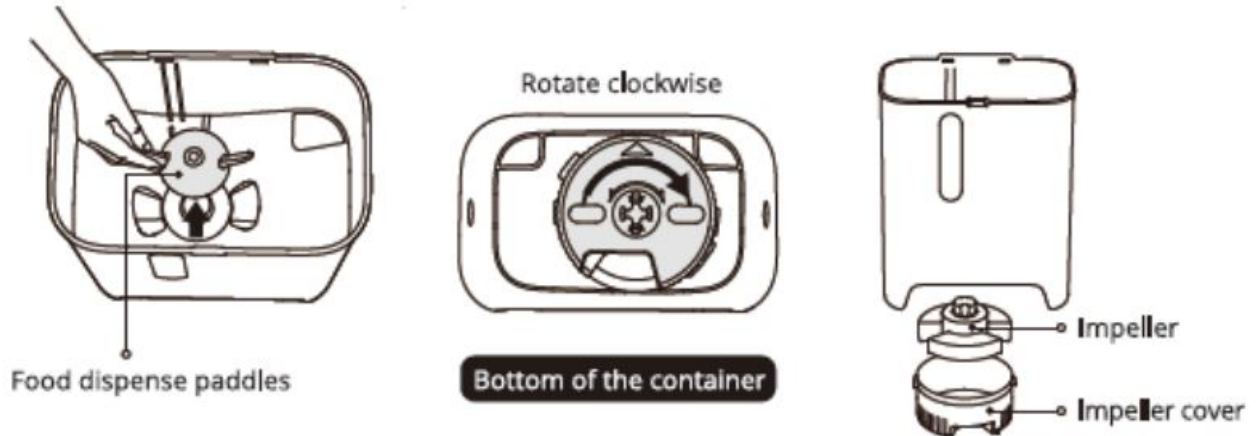

4. Clean the food storage container, paddles, impeller cover, impeller, upper lid, and food bowl in turn, it is recommended to add the appropriate amount of detergent and rinse well.
5. After cleaning, wait for each part to dry completely and install them back in turn. *Please refer to the maintenance & cleaning video for detailed steps (see the QR code below)

Please be sure to use a sponge or soft doth to clean the inside of the food storage container, do not use hard-material cleaning tools to avoid scratching the plastic parts and affecting the normal operation of the sensor. Main unit cannot be immersed or soaked in water, it can be wiped with a damp tissue.

VIDEO GUIDE

Installation & Usage Video



Scan QR code to watch

Maintenance & Cleaning Video



Scan QR code to watch

BASIC SPECIFICATIONS

Product Name	YUMSHARE DUAL-HOPPER WITH CAMERA SMART PET FEEDER	Product Weight	about 2.5kg (5.5lb)
Product Code	P591	Rated Input	6V =2A
Product Material	ABS, 304 Stainless Steel	Rated Power	4W
Product Dimensions	362 *293 *247.5mm (14.2*11.5*9.7in)	Wireless Connection	Wi-Fi
Container Capacity	5L (01 hopper 2L, 02 hopper 3L)	Scope of application	cats and small breed dogs

A MESSAGE TO OUR VALUED CUSTOMERS

- Thank you for choosing to purchase PETKIT YUMSHARE DUAL-HOPPER WITH CAMERA SMART PET FEEDER.
- Please carefully read the User Manual before using the product. By setting up and using this product, you are acknowledged that you have already read and accepted the safety guidelines listed below.
- we are not liable and will not accept responsibility for any accidents or Injuries that result from the Improper use of this product.
- PETKIT reserves the rights of Interpretation and revision.

USER SAFETY GUIDE

*Failure to follow the safety guides outlined below can result In product malfunction or other unforeseen mishaps.

- Please Install and use the product as instructed in the user Manual.
- Pets under three months of age are not recommended to use this product.
- Do not scratch or polish the camera with sharp objects.
- For indoor use only. Do not expose the product directly to sunlight for extended periods of time. Do not place it near an open flame.
- The device Is using low voltages. However, pets can still cause electrical leakage If they chew on the power cord. Please guide your pets to use the product property.
- Please use the original adapter. otherwise, it may damage the device or cause safety hazards.
- Make sure the device is placed on a level surface. Do not overturn the device, or it may not function properly.
- Do not drop all items except dry pet food into the food storage container, or the device will not function properly, and it may even endanger the safety of the pet.
- In order to prevent your pet from overtaking this device, we recommend placing il in a corner or against a wall.
- To prevent the device from falling down and injuring your pet or damaging property, please do not place this device in an elevated location.

- The main unit of the product is prohibited from soaking or submerging in water, and the machine should not be used in damp environments.
- If you want to stop using the device, make sure to remove the battery and unplug the power adapter. please clean and dry the device before storing it.
- Please unplug the power cord before moving the device.
- Children should use this product under the guidance of adults.
- Repairs should be done under the guidance of a professional to avoid safety hazards.
- If you need to go out, please check the battery in the battery compartment to make sure the battery has a sufficient charge (this device can only use alkaline batteries).

FCC

This device complies with part 15 of the FCC Rules. Operation is subject to the following two conditions:

1. This device may not cause harmful interference, and
2. this device must accept any interference received, including interference that may cause undesired operation.

FCC warning;

Any changes or modifications not expressly approved by the party responsible for compliance could void the user's authority to operate the equipment.

Note: This equipment has been tested and found to comply with the limits for a Class B digital device, pursuant to part 15 of the FCC Rules. These limits are designed to provide reasonable protection against harmful interference in a residential installation. This equipment generates uses and can radiate radio frequency energy and, if not installed and used in accordance with the instructions, may cause harmful interference to radio communications. However, there is no guarantee that interference will not occur in a particular installation. If this equipment does cause harmful interference to radio or television reception, which can be determined by turning the equipment off and on, the user is encouraged to try to correct the interference by one or more of the following measures:

- Reorient or relocate the receiving antenna.
- Increase the separation between the equipment and receiver.
- Connect the equipment into an outlet on a circuit different from that to which the receiver is connected.
- Consult the dealer or an experienced radio/TV technician for help.

warning

This device complies with Industry Canada license-exempt RSS standard(s). Operation is subject to the following two conditions:

1. This device may not cause interference, and
2. this device must accept any interference, including interference that may cause undesired operation of the device.

Disposal

The European directive 2012 / 19 / CE on Waste Electrical and Electronic Equipment(WEEE), requires that old household electrical appliances must not be disposed of in the normal unsorted municipal waste stream. Old appliances must be collected separately in order to optimize the recovery and recycling of the materials they contain and reduce the impact on human health and the environment. The crossed-out "wheeled bin" symbol on the product reminds you of your obligation, that when you dispose of the appliance it must be separately collected.

Consumers should contact their local authority or retailer for information concerning the correct disposal of their old appliances.

Documents / Resources

 <p>Material: 157g recycled paper, double-sided printing; Size: 130*138mm</p> <p>PETKIT USER MANUAL</p>	<p>PETKIT P591 YUMSHARE Dual Hopper with Camera Smart Pet Feeder [pdf] User Manual 2A72N-P591, 2A72NP591, P591, YUMSHARE Dual Hopper with Camera Smart Pet Feeder, P 591 YUMSHARE Dual Hopper with Camera Smart Pet Feeder, P591 YUMSHARE Dual Hopper , YUMSHARE Dual Hopper, Dual Hopper, Hopper</p>
---	---

[Manuals+](#)